

**CLAS**<sup>®</sup>  
GARAGE SOLUTIONS



*Solutions*  
**TIMING TOOL  
KITS**



## TIMING TOOL KITS

EASILY FIND THE CALIBRATION KIT YOU NEED BY MANUFACTURER BRAND

<b>ALFA</b>	<b>P.354</b>	<b>MAZDA</b>	<b>P.383</b>
<b>AUDI</b>	<b>P.358</b>	<b>MERCEDES</b>	<b>P.387</b>
<b>BMW</b>	<b>P.364</b>	<b>MINI</b>	<b>P.364</b>
<b>CHRYSLER</b>	<b>P.376</b>	<b>NISSAN</b>	<b>P.372</b>
<b>CITROËN</b>	<b>P.367</b>	<b>OPEL VAUXHALL</b>	<b>P.388</b>
<b>DACIA</b>	<b>P.372</b>	<b>PEUGEOT</b>	<b>P.367</b>
<b>DODGE</b>	<b>P.376</b>	<b>PORSCHE</b>	<b>P.358</b>
<b>DS</b>	<b>P.367</b>	<b>RENAULT</b>	<b>P.372</b>
<b>FIAT</b>	<b>P.354</b>	<b>SEAT</b>	<b>P.358</b>
<b>FORD</b>	<b>P.377</b>	<b>SKODA</b>	<b>P.358</b>
<b>HYUNDAI</b>	<b>P.381</b>	<b>SMART</b>	<b>P.387</b>
<b>JAGUAR</b>	<b>P.382</b>	<b>SUZUKI</b>	<b>P.383</b>
<b>JEEP/DODGE</b>	<b>P.376</b>	<b>TOYOTA</b>	<b>P.383</b>
<b>KIA</b>	<b>P.381</b>	<b>VOLKSWAGEN</b>	<b>P.358</b>
<b>LANCIA</b>	<b>P.354</b>	<b>VOLVO</b>	<b>P.391</b>
<b>LAND ROVER</b>	<b>P.382</b>		



## FIND OUR PRODUCTS IN ATELIO AND TECDOC.

Discover our range of specific tools in Atelio doc and TecDoc applications.

Our specific tools have been associated with a wide range of vehicles, Engines, OEM and other parts, to support you in your day-to-day mechanical interventions.

Our team of specialists have carefully analyzed the ranges associated with timing, spark plugs, gearboxes, suspension, wheels and oil draining.

Remember that our printed catalog represents a selection of our offer and data. Please visit our website or our partners Atelio and TecDoc for more convenient and complete research.

On the following pages, you'll see that we've reorganized the different categories of timing tools to improve layout, organized by manufacturer.

**NEW**

**A TELIO**   
**AFTERMARKET**  
INTERNATIONAL

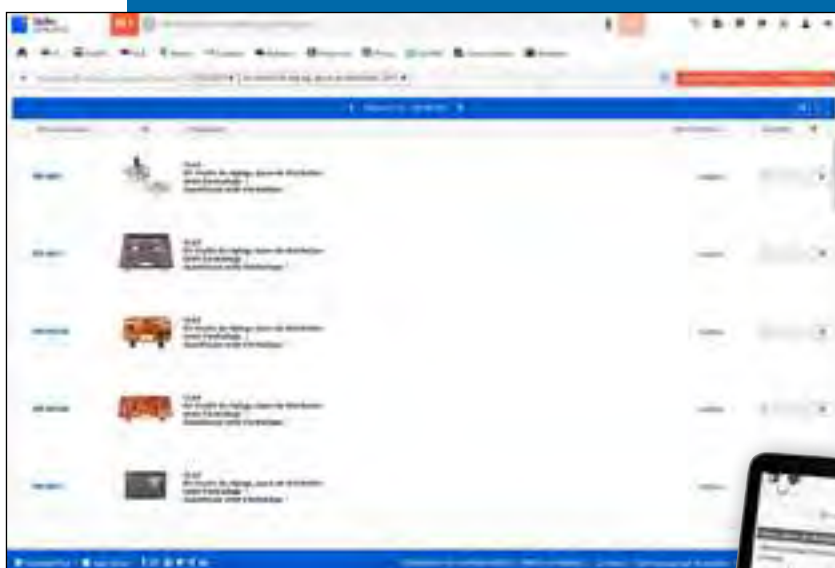

Go to [clas.com](http://clas.com)!

Technical service available at  
+33(0)4 79 72 62 22.





### GENERATION 1+2 RENAULT/PSA TIMING TOOL ROLLER CABINET

OM 9594



🔍 Code moteur, code OEM

Find the products related to your engine **code** or **OEM code** by entering them in the research bar on [clas.com](http://clas.com)



OM 6100



OM 6110



OM 6200



OM 6210



**Contents:**

- OM6110 : 1 x complete renauld timing tool set generation 2⊗
- OM6210 : 1 x complete psa timing tool set generation 2⊗
- OM6100 : 1 x master timing tool set renauld/nissan/opel/volvo generation 1
- OM6200 : 1 x master timing tool set psa generation 1
- EG0098 : 1 x 8 drawers roller cabinet



### RENAULT/PSA/FORD/VAG TIMING TOOL TROLLEY GEN1+RNLT/PSA GEN2

OM 9695



OM 6100



OM 6110



OM 6300



OM 6200



OM 6210



**Contents:**

- OM6200 : 1 x master timing tool set psa generation 1
- OM6300 : 1 x master timing tool set vag
- OM6110 : 1 x complete renauld timing tool set generation 2⊗
- OM6210 : 1 x complete psa timing tool set generation 2⊗
- EG0098 : 1 x 8 drawers roller cabinet
- OM6100 : 1 x master timing tool set renauld/nissan/opel/volvo generation 1





TN

## MULTI-BRAND TIMING TOOL TROLLEY GENERATION 1

OM 9799



OM 6100



OM 6200



OM 6300



OM 6400



OM 6500



OM 6600



**Contents:**

- OM6100 : 1 x master timing tool set renaud/nissan/opel/volvo generation 1
- OM6200 : 1 x master timing tool set psa generation 1
- OM6300 : 1 x master timing tool set vag
- OM6400 : 1 x master timing tool set fiat/alfa/lancia/opel/suzuki/ford
- OM6500 : 1 x master timing tool set opel/chevrolet/saab/fiat/lancia/suzuki/ford
- OM6600 : 1 x master timing tool set ford/mazda/volvo
- EG0098 : 1 x 8 drawers roller cabinet



## ★ TOP PRODUCT

TN

## MULTI-BRAND TIMING TOOL TROLLEY GENERATION 1 + RNLT/PSA GENERATION 2

OM 9901



OM 6100



OM 6110



OM 6200



OM 6210



OM 6300



OM 6400



OM 6500



OM 6600

**Contents:**

- OM6100 : 1 x master timing tool set renaud/nissan/opel/volvo generation 1
- OM6200 : 1 x master timing tool set psa generation 1
- OM6300 : 1 x master timing tool set vag
- OM6400 : 1 x master timing tool set fiat/alfa/lancia/opel/suzuki/ford
- OM6500 : 1 x master timing tool set opel/chevrolet/saab/fiat/lancia/suzuki/ford
- OM6600 : 1 x master timing tool set ford/mazda/volvo
- OM6110 : 1 x complete renaud timing tool set generation 2⊙
- OM6210 : 1 x complete psa timing tool set generation 2⊙
- EG0098 : 1 x 8 drawers roller cabinet





# ALFA/FIAT/LANCIA

TN

## MASTER TIMING TOOL SET FIAT/ALFA/LANCIA/ OPEL/SUZUKI/FORD

OM 6400



Cabinet drawer size

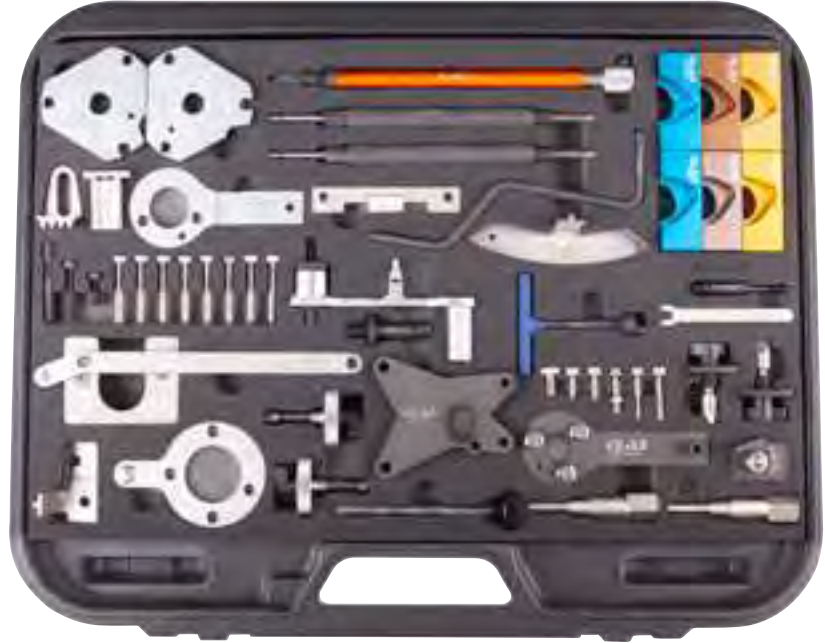

Components available in retail on [clas.com](http://clas.com)

**Models:**

- Alfa: 145, 146, 147, 155, 156, Spider, GTV, TS, GT, 159, 166, Crosswagon Q4
- Fiat: Punto, Grande Punto, Brava/Bravo, Marea, Weekend, Stilo, Doblo/Cargo, Idea, Panda, Multipla, Palio, Stilo, 500
- Lancia: Lybra, Ypsilon, Thesys, Musa,
- Opel: Corsa, Agila, Meriva, Combo, Vectra, Zafira, Astra, Insignia, Signum 1.9 CDTi
- Suzuki: Ignis, Swift, Wagon R+
- Ford: Ka

**Engines:** 1.2 8V, 1.2 16V, 1.4 16V, 1.6 16V, 1.6 MultiJet, 1.9 JTD, 1.9 JTD 16V, 1.9 MultiJet, 2.4 JTD, 1.9 CDTI, 2.0 MultiJet, 2.4 JTD 20V, 1.3 JTD MultiJet, 1.3 CDTI, 1.3 TDCI, 1.9 CDTI



Find the products related to your engine **code** or **OEM** code by entering them in the research bar on [clas.com](http://clas.com)

**NOTE**

Find our tool cabinets on p.194





**ALFA/FIAT/LANCIA**

**TIMING TOOL ALFA/FIAT/LANCIA 0.9 TWIN AIR PETROL**

OM 4053

**Models:**

Alfa Romeo: Mito (2012-15)  
 Fiat: 500, 500C, 500L (2010-15) Panda (2012-15),  
 Punto (2012-15)  
 Lancia: Ypsilon (2011-15)

**Engines:** 0.9 Twin Air Turbo  
 Engine codes: 312A2.00



TN

**TIMING TOOLS KIT FIAT 500X AND JEEP RENEGADE 1.0 / 1.3**

OM 4103

**Models:**

FIAT: 500X (2018-2022)  
 JEEP: RENEGADE (2018-2022)



TN

**TIMING TOOLS FIAT 1.2-1.4 16V PETROL**

OM 4015

**Models:** Punto, Bravo, Brava, Marea, Palio Weekend, Stilo

**Engines:** 1.2 16V, 1.4 16V



TN

**TIMING TOOLS FIAT/LANCIA/FORD PETROL**

OM 4017

**Models:**

Fiat: Idea, Punto, Grande Punto, Stilo, Panda, 500, Bravo, New Punto, Punto Evo, New Panda  
 Lancia: Ypsilon, Musa  
 Ford: Ka

**Engines:** 1.2 8V, 1.2 16V, 1.4 8V, 1.4 Bi-Fuel LPG, 1.4 Natural Power CNG, 1.2 Easy Power LPG, 1.2 Bi-Fuel LPG, 1.2 Evo



TN



## ALFA/FIAT/LANCIA

### TIMING TOOLS ALFA PETROL

TN

OM 3689



**Models:** 145, 146, 147, 155, 156, Spider, GTV TS

**Engines:** 1.4, 1.6, 1.6 16V, 1.6 16V with displacement pulley, 1.8, 2.0, 2.0 16V



### TIMING TOOLS FIAT/ALFA 1.4 MULTIAIR PETROL

TN

OM 4039



**Models:**

Alfa Romeo: Mito, Giulietta

Audi: A6

Fiat: Bravo, Doblo, Idea, Punto, Stilo, Renegade, 124, 500

Lancia: Delta, Ypsilon, Y

Opel: Combo

**Engines:** 1.2i/1.4i



### TIMING TOOLS 1.3L HDI - JTD - MULTIJET - TDCI - CDTI

TN

OM 4012



**Models:**

Alfa: 145, 146, 147, 156, 159, 166, GT, Crosswagon Q4

Fiat: Punto, Grande Punto, Bravo/Brava, Marea, Weekend,

Stilo, Doblò/Cargo, Multipla, Idea, Panda, Ducato

Lancia: Ypsilon, Musa, Lybra, Thesys

Opel: Corsa, Agila, Meriva, Combo Tour, Astra, Zafira, Vectra

Suzuki: Ignis, Swift, Wagon R+

Ford: Ka

Jeep: Renage

Citroën: Nemo

**Engines:**

1.3 JTD MultiJet, 1.3 CDTI, 1.3 TDCI, 1.6 MultiJet, 1.9 JTD, 1.9

MultiJet, 2.4 JTD, 1.9 CDTI, 2.0 MultiJet







ALFA/FIAT/LANCIA

TN

TIMING TOOLS FIAT/ALFA/LANCIA/OPEL

OM 4036



**Models:**

Alfa: 145, 146, 147, 156, 166, GT  
 Fiat: Punto, Grande Punto, Brava/Bravo Marea, Weekend, Stilo,  
 Doblo/Cargo, Multipla, Ducato  
 Lancia: Lybra, Thesys  
 Opel: Vectra, Zafira, Astra, Insigna, Signum

**Engines:** 1.6 MultiJet, 1.9 JTD, 1.9 MultiJet, 2.4 JTD, 1.9 CDTI, 2.0 MultiJet



TIMING TOOLS FIAT 2.3 JTD

OM 4025



**Applications:**

- Citroën : Jumper
- Fiat : Ducato
- Opel : Arena, Movano
- Peugeot : Boxer
- Renault : Mascott, Master, Trafic
- Vauxhall : Movano

**Engines:** 2.5D, 2.5DCI, 2.8DCI, 2.8JTD, 2.8HDI



Find the products related to your engine **code** or **OEM** code by entering them in the research bar on **clas.com**





**AUDI/PORSCHE/SEAT/SKODA/VOLKSWAGEN**

TN

**MASTER TIMING TOOL SET VAG**

OM 6300

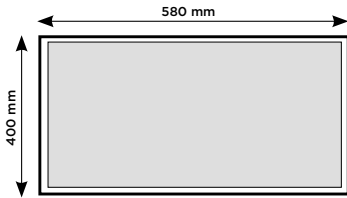

Cabinet drawer size



Components available in retail on **clas.com**

**Models:**

- Audi: 80, A1, A2, A3, A3 cabrio, S3, A4, A5, A6, TT, Q5
- Seat: Arosa, Ibiza, Cordoba, Leon, Toledo, Alhambra, Altea, Inca (99-04)
- Skoda: Fabia, Octavia, Superb
- VW: Lupo, Polo, Fox, Golf, Bora, Jetta, Golf Plus, Golf estate, Passat, Beetle, Touran, Sharan, Caddy, Caddy Maxi, Transporter, Golf VI cabrio, Tiguan
- Ford: Galaxy

**Engines:**

- Petrol: 1,2 TSI, 1,4, 1,4 TSI, 1,6 16V, 1,2 9V-12V 3cylindres, 1,4 1,6 FSi (chain), 1,8, 1,8 16V, 1,8T, 2,0 16V, 2,0 FSI/TFSI (belt)
- Diesel: 1,2 TDI PD, 1,4 TDI PD, 1,9 TDI 75-90-110 PF, 1,9 SDI 75-90-110 PF, 1,9 TDI 105-130-150 PF, 2,0 TDI PD, 2,0 TDI DPF 140-170 PF, 2,5 TDI V6



Find the products related to your engine **code** or **OEM** code by entering them in the research bar on **clas.com**

**NOTE**

Find our tool cabinets on p.194





**AUDI/PORSCHE/SEAT/SKODA/VOLKSWAGEN**

**TIMING TOOL SET VW/AUDI/  
SEAT/SKODA 1.0-1.2-1.4 TSI/TFSI**

OM 4054

Kit designed for blocking and adjusting the valve timing of 3-cylinder 1.0 petrol engines on VW UP and Polo, Skoda Citigo and Fabia, Seat Mii from 2011.

It is also used on 1.2 / 1.4 TSI - ACT / TFSI / TGI engines.



Delivered in a case



1/3 drawer format



TN



**TIMING TOOL VW 1.2-1.4 TSI**

OM 4051

**Models:**

Audi: A1 (12-18), A1 Sportback (12-18), A3 (13-18), A3 Sportback (12-17), A3 Cabriolet (14-17), Q2 (16-18), Q3 (15-18)  
 Alhambra (15-17), Ateca (16-18), Ibiza (12-17), Leon (12-18), Leon ST (14-18), Toledo (12-17)  
 Skoda: Fabia (10-13), Fabia III (14-17), Octavia II (10-13), Octavia III (10-18), Rapid (15-17), Rapid Spaceback (15-17), Yeti (15-17), Yeti Outdoor (15-17)  
 VW: Golf VII (08-17), Golf VII Estate (08-17), Golf Sportsvan (14-15), Jetta (12-17), Polo (12-17)



1/3 drawer format



TN



Delivered in a case



**TIMING CHAIN ADJUSTMENT KIT VAG 1.2-1.4-  
1.6 FSI/TFSI/TSI**

OM 9232

**Models:**

VW: Polo, Golf, Golf Plus, Touran, Passat, Jetta, Eos, Tiguan  
 Audi: A3  
 Skoda: Octavia, Fabia, Roomster

**Engines:** 1.2-1.4-1.6 FSI/TFSI/TSI (chain)



TN



**TIMING KIT VAG 1.5 TSI**

OM 4166



**Applications:**

- Audi: A1 (2018), A3 (2017), Q2 (2018), Q3(2018)  
 - Volkswagen: Arteon (2018-2020), Golf 7 (2017), Golf 8 (2019), Passat (2018), Polo (2017-2021)  
 - Seat: Arona (2017-2021), Ateca (2018), Ibiza (2017-2021), Leon (2018), Tarraco (2019)  
 - Skoda: Kamiq (2019), Karoq (2017), Kodiag (2019), Octavia 3 (2017), Octavia 4 (2019), Scala (2019), Superb 3 (2017-2020)  
 - Cupra: Leon (2022), Formentor (2020), Ateca (2023)





# AUDI/PORSCHE/SEAT/SKODA/VOLKSWAGEN

TN

## TIMING TOOLS VAG 1.2 PETROL

OM 4010

**Models:**

VW: Fox, Lupo, Polo  
Skoda: Fabia, Roomster  
Seat: Ibiza, Cordoba

**Engines:** 1.2 6V, 1.2 12V (petrol engines with chain)



## TIMING TOOLS VAG 1.8-2.0 FSI-TFSI-TSI

OM 4113

**Models:**

Audi: A4, A4 Quattro, A5 Coupe, A5 Cabriolet, A5 Sportback, A6, Q3, Q5, TT  
Seat: Alhambra, Altea, Altea XL, Exea, Leon, Toledo  
Skoda: Octavia II, Superb II, Yeti  
VW: Eos, Golf VI, Golf VI Estate, Passat, Passat Alltrack, Passat CC, Sharan, Beetle, CC, Scirocco, Tiguan

**Engines:** 1.8 and 2.0 FSI-TFSI from 2006 to 2013



1/3 drawer format



Delivered in a case



TN

## TIMING TOOL KIT VAG 2.0 TFSI AND TSI

OM 4112

**Models:**

A3, A4, A6, Golf

**Engines:** 2.0 TFSI / FSI belt



TN

## AUDI FSI TIMING TOOL SET

OM 4114

**Models:**

Audi A4, A6 B7 et C6

**Engines:** 2.4L, 3.2L V6, V8, V10



TN



AUDI/PORSCHE/SEAT/SKODA/VOLKSWAGEN

TIMING TOOLS VW/AUDI/SEAT/  
 SKODA PETROL-DIESEL

OM 4018

Q Engine codes, OEM codes  
 Find the products related to your engine **code** or **OEM** code by entering them in the research bar on **clas.com**

**Models:**

Audi: 80, A2, A3, A3 Cabrio, A4, A4 quattro, A5, A5 Coupe/Cabriolet, A6, A6 quattro, TT, Q5  
 Seat: Ibiza, Altea, Altea XL, Arosa, Ibiza/Cordoba, Inca, Leon, Toledo, Alhambra  
 Skoda: Exeo, Fabia, Fabia II, Felicia, Roomster, Octavia, Octavia Tour, Octavia II, Superb, Superb II  
 VW: Lupo, Polo, Polo/Classic, Fox, Golf/Bora, Golf/Plus, Jetta, Jetta III, Eos, Beetle, New Beetle, Scirocco, Tiguan, Passat, Passat CC, Touran, Sharan, Caddy, Vento, Caddy Maxi, Golf Estate, Sharan, Transporter

**Engines:** 1.2 TDI PD, 1.4 TDI PD, 1.7 SDI, 1.9 D/Turbo, 1.9 SDI, 1.9 TDI, 1.9 TDI PD, 2.0 TDI PD, 2.5 TDI



TIMING TOOLS VAG/FORD DIESEL 1.2 TDI PD, 1.4-1.6-1.9-2.0 CR TDI-TDCI

OM 9260

**Models:**

From 2007 (square-tooth pulleys)  
 Audi: A2, A3, A3 Cabrio, A4, A4 4WD, A5 Coupe/Cabriolet, A6, A6 quattro, Q5, TT  
 Seat: Alhambra, Altea, Altea XL, Arosa, Cordoba, Ibiza, Leon, Toledo  
 Skoda: Exeo, Fabia, Fabia II, Octavia, Octavia Tour, Octavia II, Roomster, Superb, Superb II  
 VW: Beetle, Bora, Caddy, Caddy Maxi, Eos, Fox, Golf, Golf Plus, Golf Estate, Jetta, Jetta III, Lupo, Passat, Passat CC, Polo, Scirocco, Sharan, Tiguan, Touran, Transporter  
 Ford: Galaxy

**Engines:** 1.2 TDI PD, 1.4 TDI PD, 1.6 TDI CR, 1.9 TDI PD, 2.0 TDI PD, 2.0 TDI CR



TIMING TOOLS VAG 1.6-2.0 TDI

OM 4037

**Models:**

Audi : A3, A4, Q5, A6, TT  
 VW : Beetle, Golf, Golf plus, Passat, Tiguan, Scirocco  
 Seat : Altea, Eos  
 Skoda : Octavia, Superbe, Yeti

**Engines:** 2.0D TDI





## AUDI/PORSCHE/SEAT/SKODA/VOLKSWAGEN

TN

### PORSCHE CAYENNE/PANAMERA V8 TIMING TOOL SET

OM 5050

**Models:**

Porsche Cayenne, Cayenne S, GTS, Turbo (9PA), Panamera >2008, Panamera S, 4S, GTS, Turbo, Turbo S

**Engines:** 4.5-4.8L V8



### TIMING TOOLS VAG 1.4- 1.6-2.0 CR TDI

OM 4057

**Models:**

Audi: A1, A3 Cabrio, A3, A3 Sportback, A4, A4 Allroad, A4 Quattro, A5 Coupé, A5 Cabrio, A5 Sportback, A6, TT, Q5  
Skoda: Octavia III

Seat: Leon, Leon ST

Volkswagen: Polo, Golf VII, Golf VII Estate, Golf VII Wagon, Golf SV, Golf Sportsvan

**Engine:** 1.4 CR TDI, 1.6 CR TDI, 1.6 CR TDI GreenLine, 1.6 CR TDI Ecomotive, 1.6 CR TDI BlueMotion, 2.0 CR TDI, 2.0 CR TDI Ultra, 2.0 RS CR TDI, 2.0 CR GTD



1/3 drawer format

Delivered in a case



TN

### ADJUSTMENT KIT VAG 2.5 PD TDI

OM 4055

**Models:** Touareg, Transporter

**Engines:** 2.5 TDI PD



TN

### TIMING TOOLS VAG 2.7-3.0- 4.0 TDI

OM 4032

**Models:**

Audi: A4, A5, A6, A8, Q7  
VW: Touareg

**Engines:** 2.7TDI-3.0TDI



TN



## AUDI/PORSCHE/SEAT/SKODA/VOLKSWAGEN

## SEAL TOOL KIT 24PCS

TN

OM 5038

This kit allows the SPI seals to be replaced with diameters of Ø21.5 to Ø64mm.

Removal: compact puller with unique extracting hooks, quick removal without any damaging.

Installation: the interchangeable seal mandrels mean that the seal can be guided back into place for perfect positioning.

2 pairs of claws L.70 and L.115mm for increased polyvalence.

2  
WARRANTYFORK SEAL INSTALLATION/REMOVAL  
CRANKSHAFT TOOL VAG 1.4-1.6

TN

OM 5035

Installation tool specially designed to remove and install crankshaft spits (rear seals) on 1.2L

TDI ,1.4 and 1.6 engines of most VAG vehicles.

Allows correct alignment of the joint in its housing.



Also compatible with some 3 and 4 cylinder VAG petrol and diesel engines: 1.9-2.0 SDI, 2.0 TDI, 2.0 Common rail, 1.2l TDI, 1.4T, 1.4-1.6 direct gasoline injection; and some Fiat 1.6 direct injection engines.

**Models:**

Audi: A3, A4

Seat: Arosa, Ibiza, Cordoba, Leon, Toledo

Skoda: Fabia, Fabia II, Octavia, Roomster

Volkswagen: Lupo, Polo, Polo Classic, Golf, Bora, Beetle, Caddy,

Touran

**Engine:** 1.4, 1.4 16v, 1.6

2  
WARRANTY

Find the products related to your engine **code** or **OEM** code by entering them in the research bar on **clas.com**



## BMW - MINI

### BMW/MINI/PSA (N13/N18/EP6) TIMING TOOL SET PETROL 1.6

OM 4077

**Models:**

BMW: every vehicules equipped with N13 engine  
Mini: every vehicules equipped with N18 engine  
Citroën: 1.6  
Peugeot: 1.6



TN

### TIMING TOOLS BMW 1.6-2.0 PETROL N43

OM 3767

**Models:** 116i, 118i, 120i (E81/82/87/88),  
316i, 318i, 320i (E90/91/92/93), 520i  
(E60/61)

**Engines:** 1,6, 2,0



TN

### CRANKSHAFT LOCKING TOOL PULLEY BMW/MINI B38/B48/B58/B37/B47/B57

OM 5063

**Applications:**

- BMW: series: 1, 2, 3, 4, 5, X1, X3, X4, X5  
- MINI: Hatch, Clubman, Cabriolet



TN

### TIMING TOOL SET BMW/MINI B37/B47/ B57 1.5-2.0-3.0 DIESEL

OM 5062

**Models :**

BMW: 1, 2, 3, 4, 5 Series, X1, X3, X4, X5  
Engines :  
1.5 B37C15A, B37D15A,  
2.0 B47C20A, B47C20B, B47D20A,  
B47B20B  
3.0 B57D30A

**Models :**

MINI: Hatch, Clubman, Cabriolet  
Engines :  
1.5 B37 C15A  
2.0 B47 C20A



TN





TIMING TOOLS MINI/PSA 1.4-1.6 VTI - THP16V  
 PETROL AND TURBO

OM 3748

**Models:**

Mini: One (R56), Mini Cooper (R55/R56), Clubman, Clubvan, Countryman, Coupe, Paceman, Roadster  
 Citroën: C3 III, C4, C4 Picasso, C5III, DS3, Berlingo III, DS3, DS4, DS5  
 Peugeot: RCZ, 207, 308, 2008, 3008, 5008, Partner III

**Engines:** 1.4 VTI, 1.6 VTI, 1.6 THP



TN



TIMING TOOLS BMW/ROVER/OPEL  
 DIESEL WITH CHAIN DRIVE

OM 3858

Suitable for engines equipped with a turbo.



1/3 drawer format

**Models:**

BMW: 116 E81/82/87/88 (08-12), 118 E81/82/87/88 (04-14), 120 E81/82/87/88 (04-14), 123 E81/82/87/88 (07-14), 316 E90/91/92/93 (09-12), 318 Compact E46 (01-05), 318 E90/91/92/93 (05-12), 320 Compact E46 (98-05), 320 E90/91/92/93 (05-12), 325 E90/91/92/93 (02-14), 330 E46/90/91/92/93 (99-14), 335 E90/91/92 (06-11), 520 E39/60/61 (00-10), 525 E39/60/61 F10-11 (00-12), 530 E46/60/61 F10/11 (98-13), 530GT F07 (09-12), 535 E60/61 F10-11 (04-12), 535GT F07 (10-12), 635 E63/64 (07-11), 730 E38/65/66 F01/02/04 (98-12), 740 F01/02/04 (09-12), 740 xDrive F01/02/04 (09-12), X1 sDrive E84 (09-12), X1 xDrive E84 (09-14), X3 E83 (03-10), X3 xDrive E83 (08-12), X5 E53/70 (00-12), X5 xDrive E70 (10-13), X6 E71/72 (08-10), X6 xDrive E71/72 (10-14)  
 Mini: Mini (10-14), Clubman (10-14), Clubvan (12-14), Countryman (10-14), Paceman (13-14), Roadster (12-14)  
 Land Rover: Freelander TD4 (00-06), Range Rover TD6 (02-06)  
 Rover-MG: MG-ZT/T (01-05), 75 CDT/CDTI (99-05)  
 Opel: Omega B (01-03)  
 Toyota: Verso 1.6D4D

**Engines:** 1.6, 1.8, 2.0, 2.3, 2.5, 3.0, 3.5, 4.0 diesel



Delivered in a case



TN



CAMSHAFT LOCKING TOOL BMW  
 CHAIN DRIVE N47/N57 2.0-3.0

OM 5064



TN





## BMW - MINI

### TIMING TOOLS PSA/BMW MINI W16D

OM 4758



**Models:**

Mini: Mini, Clubman  
Citroën: C2, C3, C3 Picasso, C4, C4 Picasso, Grand Picasso, Xsara Picasso, C5 II, C5 III, Berlingo III  
Peugeot: 206, 206 CC, 207, 207 CC, 307, 308, 308 CC, 1007, 3008, 5008, Partner III

**Engines:** 1.6 diesel



### PSA/BMW INTERMEDIATE SHAFT SPRING INSTALLATION AND REMOVAL TOOLS

OM 3755

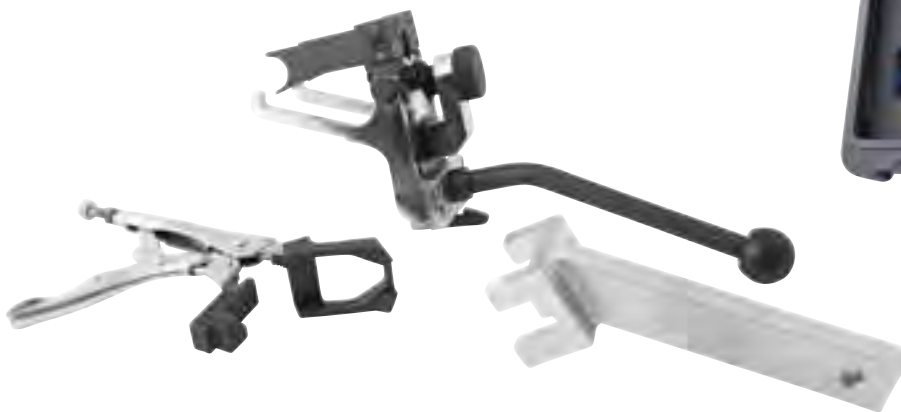

**Models :**

BMW/MINI: Mine one, Clubman, Clubvan, Countryman, Coupe, Paceman, Roadster  
PSA: C3, C3 Picasso, C4, C4 Picasso, C5, DS3, DS4, DS5, 207, 208, 2008, 3008, 508, 5008, RCZ



### CRANKSHAFT LOCKING PIN

SA 6294



**Models:**

BMW: 1.6-1.8-2.0-2.5-3.0  
Mini Cooper/Cooper S: 1.4-1.6  
Citroën: C4/C4 Picasso  
Peugeot: 207/207 CC, 308





CITROËN/DS/PEUGEOT

TN

MASTER TIMING TOOL SET PSA GENERATION 1

OM 6200

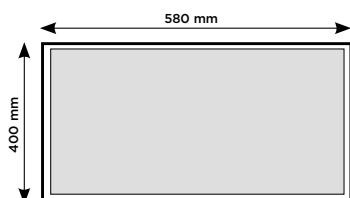

Cabinet drawer size



Components available in retail on [clas.com](http://clas.com)

**Models:**

Fiat/Lancia: Ulysse, Scudo, Ducato, Zeta, Phedra  
 Ford: Fiesta, Fusion, Focus, Focus C-Max  
 Citroën: C15, C1, C2, C3 Pluriel, C4, C4 Picasso, C5, C6, C8, DS3, DS4, DS5, Xantia, Xsara, Xsara Picasso, Evasion, Berlingo, Jumpy, Jumper, Saxo, ZX, XM, Evasion, AX  
 Peugeot: 107, 1007, 206 cc, 207, 208, 306, 307 cc, 308, 406, 407, 508, 607, 806, 807, Partner, Expert, Boxer, 206, 106, 605, 205, 405

**Engines:**

Fiat/Lancia: 2.0, 2.2 JTD  
 Ford: 1.4, 1.6 Duratorq TDCI  
 PSA: 1.0, 1.1, 1.4, 1.6, 1.6 16V, 1.4, 1.6 HDI, 1.8, 1.8 16V, 2.0, 2.0 turbo, 1.9 D, 2.0 HDI, 2.2 HDI, 1.8 16V, 2.0 16V



COMPLETE PSA TIMING TOOL SET  
 GENERATION 2©

OM 6210



TN

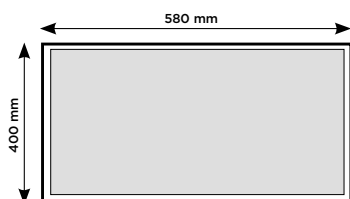

Cabinet drawer size



Components available in retail on [clas.com](http://clas.com)

**Models:**

PSA: 1007, 108, 206, 206 CC, 207, 207cc, 208, 2008, 301, 307, 308, 308cc, 308, 3008, 407, 407 Coupé, 5008, 607, Partner III  
 C2, C3, C3 Picasso, C3, C3111, C4, C4 Picasso, C4, C4 Picasso, Grand Picasso, C5 II, C5 III, C6, Berlingo III, DS3, DS3 Cab, C-Elysée, Xsara Picasso  
 Mini: One (R56), Mini Cooper (R55/R56), Mini Cooper S (R55/R56), Cooper/S, Mini One, Clubman  
 Jaguar: S-Type, XF, XJ, XJ6  
 Land Rover: Range Rover Sport, Discovery 3 & 4  
 Toyota: Aygo, Proace City



Delivered in a case

**Engines:** 1.0, 1.2i, 1.4, 1.4 VTI, 1.6, 1.6 VTI, 1.6 THP, 1.6 diesel, 1.8, 2.0, 2.5, 3.0 L, 2.7 D/TDV6/HDI/TDVi





## CITROËN/DS/PEUGEOT

### TIMING TOOLS PSA 1.0-1.2 3 CYLINDERS PURETECH

OM 4041

Accessory of OM 4058

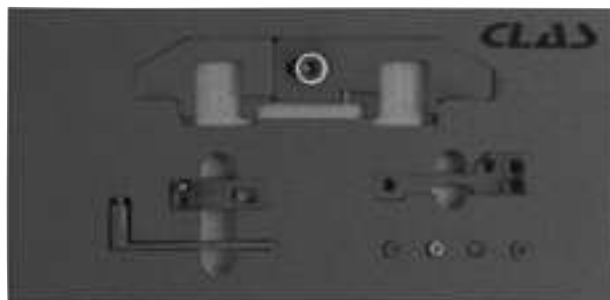

1/3 drawer format



Engine codes, OEM codes

Find the products related to your engine **code** or **OEM** code by entering them in the research bar on **clas.com**



Delivered in a case



**Models:**

Peugeot: 108, 208, 2008, 301, 308, 3008, 5008  
 Citroën: C3111, DS3, DS3 Convertible, C-Elysée  
 Toyota : Aygo, Proace City

**Engines:** 1.0, 1.2i



### TIMING TOOLS PSA 1.2 12V TURBO 3 CYLINDERS PURETECH

OM 3797

This kit eliminates the need to remove the following engine components:

- fuel pump
- injectors
- fuel rail
- the second aluminum cylinder head cover

You won't have to replace the original gasket on the aluminum cylinder head cover, or any other O-rings or copper seals. The Pure tech Turbo engine is equipped with a vacuum pump, so you can go directly to the camshaft via the drive flat.

Also available for naturally-aspirated engines: PSA 1.0-1.2 VVT 3-cylinder Puretech OM 4041 timing set.



1/3 drawer format



**Models:**

- Citroën: Berlingo II, Berlingo III, C3 IV, C3 Aicross, C3 Picasso, C4 Cactus, C4 III, C4 Picasso, C4 Space Tourer, C5 Aircross
- Peugeot: 208 I, 208 II, 2008, 2008 II, 308 II, 3008 I, 3008 II, 5008, 5008 II, Partner
- Opel: Combo-E (X19), Combo-E Life (X19), Crosslande X (P17), Grandland X (A18), Corsa VI, Mokka II
- DS: 4, 3, 3 Crossback
- Toyota: Proace City



Delivered in a case



### CAMSHAFT TIMING PIN TOOL PURETECH EURO 6.3 VERSION

OM 3798

On new versions of the 1.2L PURETECH EURO 6.3 engine, the manufacturer's recommendations stipulate that the camshaft previously fitted in place of the vacuum pump must be replaced by a new one.

**Applications:**

- Citroën: Berlingo II, Berlingo III, C3 IV, C3 Aicross, C3 Picasso, C4 Cactus, C4 III, C4 Picasso, C4 Space Tourer, C5 Aircross
- Peugeot: 208 I, 208 II, 2008, 2008 II, 308 II, 3008 I, 3008 II, 5008, 5008 II, Partner
- Opel: Combo-E (X19), Combo-E Life (X19), Crosslande X (P17), Grandland X (A18), Corsa VI, Mokka II
- DS: 4, 3, 3 Crossback
- Toyota: Proace City





**CITROËN/DS/PEUGEOT**

**1.2 PURETECH PETROL OIL  
 CRANKCASE ALIGNMENT PLATE**

OM 3796



**CRANKSHAFT HOLDING TOOL**

OM 3799



**CRANKSHAFT SEAL ASSEMBLY TOOL  
 1.0-1.2 PURETECH**

OM 4142

Accessory of OM 3747/OM 4041/OM 3797



**CAMSHAFT LOCK PIN**

SA 3797

Spare part of OM 3797  
 Accessory of OM 3747



**STRETCH BELT INSTALLATION  
 AND REMOVAL TOOL PSA**

OM 4058

Accessory of OM 3797/OM 4041



**Models:**

Peugeot: 108, 208, 301, 308, 408,  
 2008, 3008, 5008, Partner  
 Citroën: C1, C3, C3 Picasso, C3  
 Aircross, C4, C4 Picasso, C4  
 Cactus, C-Elysée, Berlingo, DS3,  
 DS4, DS4 S, DS5 LS  
 Opel: CrosslandX

**Engines:** PureTech 1.0, 1.2L from  
 2012.



**FEMALE CYLINDER HEAD  
 SOCKET TYPE E12X140**

OM 4552



**BELT GAUGE PSA 1.0/1.2  
 PURETECH**

OM 4141

Spare part of OM 4041/OM 4058



**Peugeot:** 2008, 208, 308, 5008, 3008





## CITROËN/DS/PEUGEOT

### PSA/BMW INTERMEDIATE SHAFT SPRING INSTALLATION AND REMOVAL TOOLS

OM 3755

**Models :**

BMW/MINI: Mine one, Clubman, Clubvan, Countryman, Coupe, Paceman, Roadster  
PSA: C3, C3 Picasso, C4, C4 Picasso, C5, DS3, DS4, DS5, 207, 208, 2008, 3008, 508, 5008, RCZ



TN

### TIMING TOOLS MINI/PSA 1.4-1.6 VTI - THP16V PETROL AND TURBO

OM 3748

**Models:**

Mini: One (R56), Mini Cooper (R55/R56), Clubman, Clubvan, Countryman, Coupe, Paceman, Roadster  
Citroën: C3 III, C4, C4 Picasso, C5III, DS3, Berlingo III, DS3, DS4, DS5  
Peugeot: RCZ, 207, 308, 2008, 3008, 5008, Partner III

**Engines:** 1.4 VTI, 1.6 VTI, 1.6 THP



TN

### TIMING TOOLS PSA/FORD/TOYOTA/ OPEL 1.5 BLUEHDI / 1.4, 1.6 HDI

OM 4105

**Models:**

Citroën: Berlingo III, C3 III, C3 Aircross, C4 Cactus, C4 Spacetourer, C5 Aircross, Berlingo III Van, Traveller, Jumpy  
Mazda : 2, 3, 5  
Peugeot: 208 II, 2008 II, 308 II, 308 III, 508 II, 3008 II, 5008 II, Rifter, Partner, Expert  
Opel: Corsa (F) VI, Mokka, Crossland, Grandland, Combo, Combo Cargo, Zafira, Vivaro  
Suzuki : Liane (RH), SX4 (RW)  
Toyota: Proace City, Proace City Verso, Proace, Proace Verso

**Engines:** 1,5 Blue HDI



TN

### TIMING TOOLS 1.4-1.6 HDI-TDCI 1.8-2.0 PETROL-DIESEL

OM 3777

**Models:**

Fiat/Lancia: Scudo, Zeta, Phedra  
Ford: Fiesta, Fusion, Focus, Focus C-Max  
Citroën: C1, C2, C3, C3 Pluriel, C4, C4 Picasso, C5, C6, C8, DS3, DS4, Xantia, Xsara, Xsara Picasso, Evasion, Berlingo, Jumpy, Jumper, Saxo, ZX, XM, Evasion, AX  
Peugeot: 107, 1007, 206 cc, 207, 208, 306, 307 cc, 308, 406, 407, 607, 806, 807, Partner, Expert, Boxer, 206, 106, 605, 205, 405

**Engines:**

Fiat/Lancia: 2.0 16V  
Ford: 1.4 -1.6 Duratorq TDCI  
PSA: 1.4 -1.6 HDI, 1.8, 1.8 16V, 2.0, 2.0 turbo, 1.8 16V, 2.0 16V



TN



CITROËN/DS/PEUGEOT

TN

TIMING TOOLS PSA/FIAT 1.4-1.6-2.0-2.2-3.3-3.8

OM 4102



🔍 Engine codes, OEM codes  
Find the products related to your engine **code** or **OEM** code by entering them in the research bar on **clas.com**



**Models:**

Fiat/Lancia: Ulysse, Scudo, Ducato, Zeta, Phedra  
Citröen: C1, C2, C3, C3 Picasso, C3 Pluriel, C4, C4 Picasso/Grand Picasso, C5, C6, C8, C-Crosser, DS3, DS4, DS5, Berlingo, Jumpy/Dispatch, Jumper/Relay, Nemo, Xantia, Xsara, Xsara Picasso, Evasion/Synergie, Saxo, ZX, XM, AX, C15  
Ford: Focus, C-Max, Focus C-Max, Kuga Transit  
Land Rover: Evoque, Defender  
Mitsubishi: ASX, Outlander 2, Lancer  
Hyundai: Genesis Coupé, IX55, Vera Cruz, Azera, Grandeur, Sonata, Sonica  
Kia: Opirus, Sorento  
Peugeot: 107, 1007, 206, 206+, 206 cc, 207, 207 cc, 208, 306, 307, 307 cc, 308, 308 cc, 3008, 406, 406 coupé, 407, 407 coupé, RCZ, 4007, 4008, 508, 5008, 607, 806, 807, Partner, Bipper, Expert, Boxer, 106, 605, 205, 405  
Toyota : Proace, Verso

**Engines:** 1.4 HDI, 1.6 HDI, 1.9, 2.0 JTD, 2.0 HDI, 2.2 TDCI, 2.2 JTD, 2.2 HDI, 2.2 DID, 2.4 TDCI, 3.2 TDCI 3.3 V6 petrol, 3.8 V6 petrol



TIMING TOOLS PSA/BMW MINI W16D

OM 4758



TN



**Models:**

Mini: Mini, Clubman  
Citröen: C2, C3, C3 Picasso, C4, C4 Picasso, Grand Picasso, Xsara Picasso, C5 II, C5 III, Berlingo III  
Peugeot: 206, 206 CC, 207, 207 CC, 307, 308, 308 CC, 1007, 3008, 5008, Partner III

**Engines:** 1.6 diesel



TIMING TOOLS PSA/LAND ROVER/JAGUAR 2.7/3.0 V6 (TDV6)

OM 4070



TN



**Models:**

Citröen: C6, C5  
Peugeot: 407, 607, 407 coupé  
Land Rover: Range Rover Sport, Discovery 3, Discovery 4  
Jaguar: S-Type, XJ Series

**Engines:** 2.7 TDV6, 2.7 D, 2.7 HDI, 3.0 SDV6/TDV6





**DACIA/RENAULT/NISSAN**

TN

**MASTER TIMING TOOL SET RENAULT/NISSAN/  
OPEL/VOLVO GENERATION 1**

OM 6100



Cabinet drawer size



Components available in retail on **clas.com**

**Models:**

Renault: Clio 1-2-3-4, Clio Sport 1-2-3, Mégane 1-2-3, Master 1-2, Mégane Scénic 1-2-3, Vel Satis 1-2, Avantime, Kangoo 1-2-3, Laguna 1-2-3, Espace 1-2-3, Trafic 1-2, Wind, Modus, Twingo, Koleos  
Dacia: Logan, Duster, Sandero, Dokker  
Nissan: Note, Qashqai, Micra, Interstar, Primastar, Kubistar, Almera, Primera  
Opel: Vivaro, Movano  
Volvo: S 40, V 40

**Engines:** 1.2, 1.2 16V, 1.4, 1.4 16V, 1.5 DCI, 1.6, 1.6 16V, 1.6 D, 1.7, 1.8, 1.8 16V, 1.9 TD, 1.9, 1.9 DCI, 1.9 DTI, 1.9 CDTI, 2.0, 2.0 16V, 2.1 TD, 2.2, 2.2 DCI, 2.2 DTI, 2.2 TD, 2.5 DCI, 2.5 CDTI, 2.5 TD, 2.8 D



**COMPLETE RENAULT TIMING  
TOOL SET GENERATION 2©**

OM 6110



TN

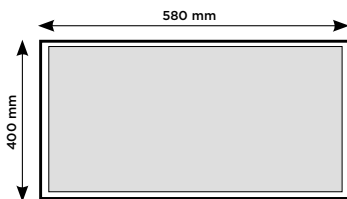

Cabinet drawer size



Components available in retail on **clas.com**

**Applications:**

Renault: Clio II, Espace 4 et 5, Fluence, Koleos, Laguna, Laguna 2, Latitude, Master, Megane, Megane 2, Scenic, Scenic RX4, Scenic 2, Grand Scenic 2, Trafic 2, Vel Satis  
Mercedes: Class C, 622.951, Vito  
Mitsubishi: Carisma  
Nissan: Navara NP300, Primastar X83, Qashqai 1 et 2, X-Trail  
Opel: Arena, Vivaro-B

**Engines:** 1.4, 1.6, 1.8 16v, 2.0 16v, 1.6, 2.0, 2.3, 2.5, 3.5, 1.9DTI/TD, 2.3DCI/CDTI



Delivered in a case







## CRANKSHAFT LOCKING TOOL PULLEY 0.9-1.2 TCe

TN

OM 5070

Designed to allow loosening and tightening of the fastener by immobilizing the pulley.  
 The kit is designed for Renault 0.9 L and 1.2 L gasoline engines used in Renault, Dacia and Smart cars



**Modeles:**

Dacia: Dokker, Duster, Lodgy, Logan, Sandero  
 Renault: Capture 2013>2019, Clio IV 2012>2019, Kadjar 2015>2018, Kangoo II 2013+, Mégane III 2012>2017, Mégane IV 2016>2020, Scénic/Grand Scénic III 2012>2017, Scénic/Grand Scénic IV 2016>2018, Twingo II >2004  
 Smart: Fortwo, Forfour 2014>2019

**Engines:** 0,9, 1,2 TCe



## TIMING TOOL SET 1.3 TCe

TN

OM 3697



1/3 drawer format



Delivered in a case

**Models:**

Renault: Arkana (XJC) (19-), Capture (J87) (13-19), Captur II (XJB) (19-), Clio V (XJA) (19-), Kadjar (HFE), Koléos II (HZG) (17-), Mégane IV (BFB/KFB/LFF) (16-), Scénic/Grand Scénic IV (JFA/RFA) (16-), Talisman (KFD/LFD)(15-).  
 Mercedes: A-Class (177) (18-), B-Class (247) (19-), CLA Coupe (118) (19-), CLA S/Frein (118) (19-), GLA (247) (20-), GLB (247) (19-).  
 Nissan: Qashqai (J11) (14-), X-Trail (T32)(14-).  
 Dacia: Dokker (F/K67), Plumeau (HJD) (17-), Lodgy (J92).

**Engines:** 1,3 TCe



## TOOLS DACIA NISSAN MERCEDES 0.9-1.6 ET 1.3 TCe ENGINE WHEEL BLOCKING

OM 4160



**Models :**

- Dacia : Dokker (2019), Duster (2018), Lodgy (2019), Logan (2013), Sandero (2013)  
 - Mercedes : Classe A (2018), Classe B (2019), CLA (2019), GLA (2019), GLB (2019)  
 - Nissan : Qashqai (2018), X-Trail (2018)  
 - Renault : Arcana (2019), Captur (2018), Clio V (2019), Kadjar (2018), Megane IV (2017), Scenic/Grand Scenic (2018), Talisman (2018)





## DACIA/RENAULT/NISSAN

### TIMING PINS RENAULT/OPEL/NISSAN

OM 3666

**Engines:** 1.6D, 1.9D, 1.9TD, 1.9TDI, 1.9DCI, 1.5DCI, 1.2, 1.4, 1.6, 1.8, 1.4 16V, 1.6 16V, 1.8 16V

Camshaft/crankshaft timing pins



TN

### TIMING TOOLS RENAULT/NISSAN

OM 4005

**Models:**

Renault: Clio 2-3-4, Clio Sport 2-3, Mégane 2-3, Mégane Scenic 1-2-3, Vel Satis 1-2, Avantime, Kangoo 2-3, Laguna 1-2-3, Espace 2-3, Modus, Koleos

Dacia: Logan, Duster, Sandero, Dokker

Nissan: Note, Qashqai, Micra, Kubistar, Almera, Primera

**Engines:** 1.4 16V, 1.6 16V, 1.8 16V, 2.0 16V, 2.0 16V turbo, 1.5 DCI



TN

### TIMING TOOLS RENAULT/OPEL/NISSAN/SUZUKI DCI

OM 3674

**Models:**

Renault: Clio, Kangoo, Laguna, Espace, Master, Mégane/Scénic, Trafic

Nissan: Kubistar, Interstar, Qashqai

Opel: Vivaro, Movano

Suzuki: Grand Vitara

**Engines:** 1.5 DCI, 1.9 TD, 1.9 DCI, 2.2 DCI, 2.5 DCI



TN



DACIA/RENAULT/NISSAN

TN

TIMING TOOL SET  
 RENAULT 2.0D BLUE DCI

OM 5071



🔍 Engine codes, OEM codes  
 Find the products related to your engine **code** or **OEM** code by entering them in the research bar on **clas.com**



**Applications:**

Renault: Talisman, Espace V, Trafic III (>2020)  
 Engines : 2,0 Blue DCI



TIMING TOOL RENAULT/NISSAN/OPEL 1.6-2.0-2.3 DCI-CDTI

OM 3686



1/3 drawer format

**Models:**

Fiat: Talento 2  
 Renault: Megane, Scenic, Laguna, Latitude, Fluence, Espace, Trafic, Koleos, Vel Satis  
 Nissan: Primastar, Qashqai, X-trail, NV 400  
 Opel: Vivaro, Movano  
 Mercedes: C180



Delivered in a case

**Engines:**

1.6, 2.0, 2.3 DCI et CDTI





CHRYSLER

JEEP - DODGE

TIMING TOOLS MERCEDES/CHRYSLER/JEEP  
PETROL-DIESEL DCI - CRD

TN

OM 9283

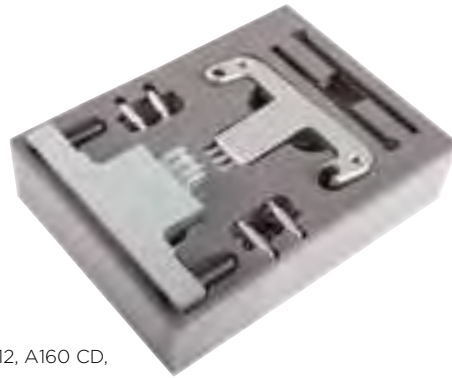

**Models:**

Mercedes: 190, 200, 300, 500, 208, 210, 600sl, 300sl, 308d, 500sl, 410d, 812, A160 CD, B180 CDI, B200 CDI, C180, C200D

Chrysler: PT Cruiser

Jeep: Grand Cherokee

**Engines:** 1.6, 1.8, 2.0, 2.1, 2.2, 2.2 CRD, 2.3, 2.5, 2.7, 2.7 CRD, 3.0, 3.2, 3.9, 4.0, 4.2, 5.0



CHRYSLER 2.8D TIMING TOOL SET

TN

OM 4127



**Models:**

Jeep: Cherokee, Wrangler  
Chrysler: Grand Voyager

**Engines:** 2.8D



TIMING TOOLS CHRYSLER 2.5-2.8 CRD

TN

OM 4129



**Models:**

Voyager, Grand Voyager, LDV Maxus

**Engines:**

2.5, 2.8 CRD





FORD

TN



# MASTER TIMING TOOL SET FORD/MAZDA/VOLVO

OM 6600

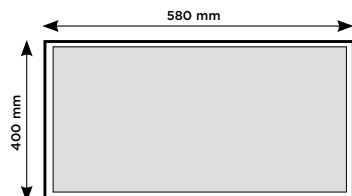

Cabinet drawer size



Components available in retail on [clas.com](http://clas.com)

**Models:**

Ford: Fiesta, Fusion, Courier, Escort, Focus, Focus C Max, Puma, Mondeo, Sierra, Transit, Connect, Cougar, Courier, Courier Kombi, Galaxy ,C-Max ,Orion, Tourneo Connect, Transit, Transit Connect

VW: Sharan

Seat: Alhambra

Mazda: 121

Volvo: S40, V50 petrol, 1.8 D, 1.8 TD, 240 D, 740 D, 760 D, 940 D, 960 D Turbo

**Engines:** 1.2, 1.4, 1.6, 1.6 16V, 1.7 16V belt, 1.8-2.0 16V (belt et chain), 1.4, 1.6 16V Focus et Mazda 121, 1.6 Duratorq TDCI, 1.8 D, 1.8 TD (88-00), 1.8 DI (belt) (98-04), 1.8 TDCI (belt) (01-04), 1.6 D, 1.9 TDI, 2.5 D/TCI (belt), 1.9 TDI, 2.5 D/TCI (belt), 1.25, 1.6 TI-VCT, 1.6 SCTI, 1.4 D TDCI, 1.6 D TDCI, 1.8 D, 1.8 D TCI, 1.8 D TDDI, 1.8 D TDCI, 1.8 D Turbo, 1.8 D Turbo, 1.9 D TDI PD, 1.9 D TDI PD, 2.0 D TDCI, 2.2 TDCI, 2.5 D, 2.5 D Turbo, 2.0, 2.2, 2.4 Duratorq TDCI 16V, 1.4 D TDCI, 1.6 D 8V, 1.6 D 16V



Find the products related to your engine **code** or **OEM** code by entering them in the research bar on [clas.com](http://clas.com)



# FORD

## TIMING TOOL SET FORD 1.0 ECOBOOST

OM 4117

TN

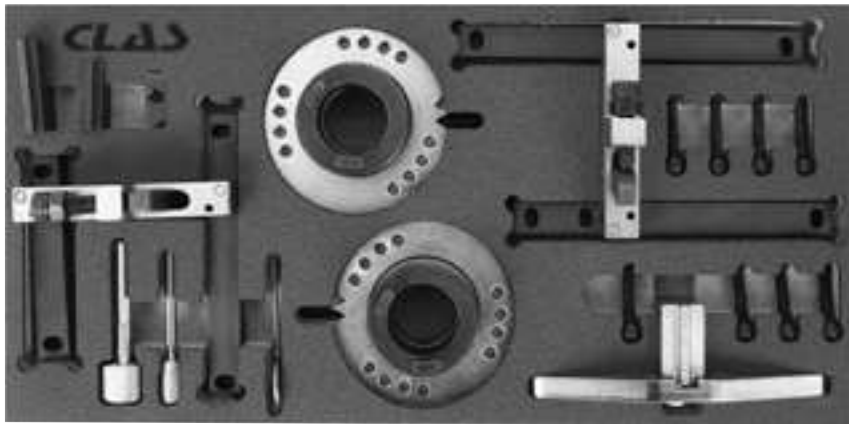

1/3 drawer format



Delivered in a case

**Models:**

Ford: B-Max (2013-2017), C-Max (2012-2017), Connect (2013-2016), Courier (2012-2016), EcoSport (2013-2017), Fiesta (2013-2017), Focus (2012-2017), Grand C-Max (2012-2017), Grand-Tourneo Connect (2013-2015), Mondeo (2015-2017), Transit Connect (2015-2017).

**Engine:** 1,0 Ecoboost



## FORD 1.0 & 1.1 ECOBOOST TORQUE MULTIPLIER

OM 4109

TN



**Specifications:**

- 5:1 torque ratio (corresponds to the manufacturer's specifications)
- max. input torque 300 Nm - per 1/2" female drive
- max. output torque 1500 Nm - per 3/4" male drive
- including 21mm/24mm A/F hexagon socket.

**Models:**

Ford: Ford B-Max (2012-2018), Ford C-Max (2012-2018), Ford Grand C-Max (2017-2018), Ford EcoSport (2015-2019), Ford Fiesta (2012-2019), Ford Focus (2012-2018), Ford Mondeo (2015-2018), Ford Transit Courier (2014-2020), Ford Transit Connect (2013-2018), Ford Grand Tourneo Connect (2013-2018), Ford Tourneo Courier (2014-2020)





FORD

TN

## CAMSHAFT AND FLYWHEEL TIMING TOOLS FORD 1.5 ECOBOOST ENGINE

OM 4111

Specific to Ford 1.5L EcoBoost 3-cylinder and Duratec engines since 2018

**NEW**



Specific to Ford 1.5L EcoBoost 3-cylinder and Duratec engines since 2018



## TIMING TOOL SET FORD 1.6 ECOBOOST 1.8-2.0 DURATEC VOLVO 1.6

OM 5016

### Applications:

- Ford: B-MAX (>2010), C-MAX (2003>2012), Fiesta (>2013), Galaxy (>2010), Focus (2004>2015), Grand C-MAX (>2010), Kuga (>2013), Mondeo (>2010), S-MAX (>2010), Tourneo Connect (>2013), Transit Connect (>2013)

- Volvo: S60 Cross Country T4 (2011>2015), S80 GTDi T3 (2010>2015), V40 GTDi T4 (2012>2015), V60 GTDi T4F (2011>2015), V70 T2/T3/T4 (2010>2015)

### Engines:

Volvo: 1.6 gtdi  
 Ford: 1.6 SCTi / Ti-VCT EcoBoost petrol  
 Ford: 1.8 Duratec-HE petrol M14  
 Ford: 1.8 Duratec-SCI petrol  
 Ford: 2.0 Duratec-HE petrol



1/3 drawer format



Delivered in a case



## TIMING TOOLS SET FORD/VW/SEAT/VOLVO/MAZDA

OM 4056

### Models:

Ford: B-MAX, C-MAX, Courier, EcoSport, Edge, Escort, Fiesta, Focus, Focus C-Max, Fusion, Galaxy, Grand C-MAX, Grand Tourneo Connect, Kuga, Mondeo, S-MAX, Tourneo Connect, Transit Connect  
 Mazda: 2 (DY)(02-07), 3 (BK)(03-09), 3 (BL)(09-14), 5 (CR), 5 (CW), 6 (GG/GY)(02-07), 6 (GH)(07-13), CX-7 (ER)(07-13), MPV (LW) (99-05), MX-5 (NC)(05-15), Tribute (EP)(01-06)  
 Volvo: C30, S40, S80, V50, V70  
 Peugeot: 307, 308, 407, 5087, 807, Expert  
 Citroën: C4, C5, Jumpy  
 VW: Sharan  
 Seat: Alhambra

### Engine:

1.4, 1.6 16V, 1.7, 1.8 16V, 2.0 16V, 2.3, 2.5 (également Zetec)  
 1.4, 1.6, 1.8, 1.9, 2.0, 2.2 D/TD/TDCi



TN



**FORD**

**TIMING TOOL SET FORD ECOBLUE 2.0 TDCi WITH PUMP INJECTION TOOL**

OM 4131



TN

**Models:**

FORD: Bord (18-21), Connect (18-), Galaxie (18-21), Kuga (19-), Mondeo (19-21), Ranger (19-), S-MAX (18-21), Transit (16-)



**BELT PULLEY PULLER FORD ECOBLUE 2.0L**

OM 4132



TN

**Applications:**

- Ford: Kuga, Ranger and Transit Custom (>2019), FWD Transit (>2018), RWD Transit (>2018)



**TIMING TOOL FORD/JAGUAR 2.0-2.2-2.4 DURATORQ**

OM 4230

It allows the removal and replacement of the fuel injection pump on Ford 2.0, 2.4 Duratorq Di/TDDi and 2.2, 2.4 Duratorq TDCi diesel engines. Also suitable for timing belt replacement on 1.4/1.6 litre engines used on Ford and PSA cars.



TN

**Models:**

Citroën: Jumper  
 Fiat: Ducato  
 Ford: Focus, Mondéo, Transit, ranger  
 Hyundai: Accent, Getz, I10, I20  
 Kia: Cerato, Picanto, Rio  
 Land rover: Defender  
 Peugeot: Boxer

**Engines:** 2.0 , 2.2 , 2.4 , 2.8 , 3.2 TDDi/TDCi/HDI  
 For engines built between 2002 and 2010







## HYUNDAI - KIA

TN

### TIMING TOOL SET HYUNDAI KIA 1.6 CRDI

OM 4128



**Models:**

KIA: Ceed (18-), Optima (15-20), Proceed (19-), Sportage (16-21), Stonic (17-), XCeed (19-).

HYUNDAI: i40 (18-), Kona (17-), Tucson (15-21).



### HIGH PRESSURE PUMP REMOVAL TOOL HYUNDAI/KIA

OM 4471



**Models:** Kia: Carens, Ceed, Optima, Rio, Soul, Sportage, Venga  
**Engines:** 1.1 TCI, 1.4 TCI, 1.4 CRDI, 1.6 TCI, 1.6 CRDI, 1.7 TCI





## JAGUAR/LAND ROVER

### TIMING TOOL SET LAND ROVER 2.0T

OM 4240

TN

**NEW**



**Models:**

Land Rover Discovery Sport, Range Rover Evoque (2015-)  
Jaguar: F-PACE, XE, XF (2015-)



### TIMING TOOL JAGUAR/LAND ROVER 2.0 PETROL

OM 4212

TN



**Models:**

Jaguar: XE (2015-16), XF (2012-15), XJ (2013-16)  
Land Rover: Discovery Sport (2015-16), Freelander (2012-15), Evoque (2011-16)

**Engines:** 2.0 GTDi, Si4  
Engine codes: 204PT



### TIMING TOOL SET LAND ROVER 2.0 D

OM 4245

TN

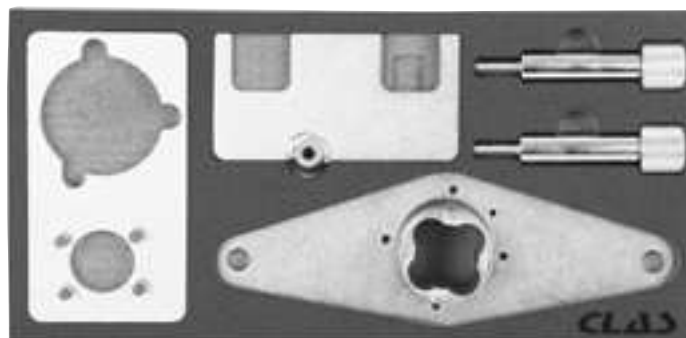

1/3 drawer format



**Models:**

LAND ROVER: Discovery, Discovery Sport, Range Rover Evoque, Range Rover Evoque Cabriolet, Range Rover Sport, Range Rover Velar  
JAGUAR: E-Pace, F-Pace, XE, XF



Delivered in a suitcase





TN

COMPLETE PSA TIMING TOOL SET  
 GENERATION 2©

OM 6210

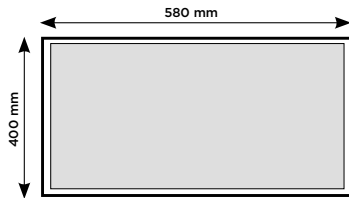

Cabinet drawer size



Retail components  
 available on [clas.com](http://clas.com)

**Models:**

PSA: 1007, 108, 206, 206 CC, 207, 207cc, 208, 2008, 301, 307, 308, 308cc, 308, 3008, 407, 407 Coupé,  
 5008, 607, Partner III  
 C2, C3, C3 Picasso, C3, C3111, C4, C4 Picasso, C4, C4 Picasso, Grand Picasso, C5 II, C5 III, C6, Berlingo III,  
 DS3, DS3 Cab, C-Elysée, Xsara Picasso  
 Mini: One (R56), Mini Cooper (R55/R56), Mini Cooper S (R55/R56), Cooper/S, Mini One, Clubman  
 Jaguar: S-Type, XF, XJ, XJ6  
 Land Rover: Range Rover Sport, Discovery 3 & 4  
 Toyota : Aygo, Proace City



Delivered in a suitcase

**Engines:** 1.0, 1.2i, 1.4, 1.4 VTI, 1.6, 1.6 VTI, 1.6 THP, 1.6 diesel, 1.8, 2.0, 2.5, 3.0 L, 2.7 D/TDV6/HDi/TDVi



Find the products associated with your **engine code** or **OEM code** by entering them in the search bar on [clas.com](http://clas.com).



**NOTE**  
 Find out more about our  
 tools cabinet p.194





## MAZDA/SUZUKI/TOYOTA

### TIMING TOOLS PSA 1.0-1.2 3 CYLINDERS PURETECH

OM 4041

Accessory of OM 4058

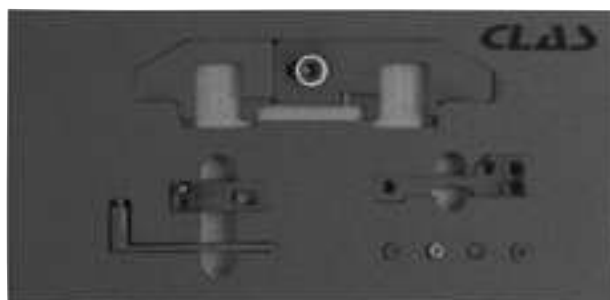

1/3 drawer format



Code moteur, code OEM

Find the products associated with your **engine code** or **OEM code** by entering them in the search bar on [Clas.com](http://Clas.com).

**Models:**

Peugeot: 108, 208, 2008, 301, 308, 3008, 5008

Citroën: C3111, DS3, DS3 Convertible, C-Elysée

Toyota : Aygo, Proace City

**Engines:** 1.0, 1.2i



Delivered in a suitcase



### TIMING TOOLS PSA 1.2 12V TURBO 3 CYLINDERS PURETECH

OM 3797

This kit eliminates the need to remove the following engine components:

- fuel pump
- injectors
- fuel rail
- the second aluminum cylinder head cover

You won't have to replace the original gasket on the aluminum cylinder head cover, or any other O-rings or copper seals.

The Pure tech Turbo engine is equipped with a vacuum pump, so you can go directly to the camshaft via the drive flat.

Also available for naturally-aspirated engines: PSA 1.0-1.2 VVT 3-cylinder Puretech OM 4041 timing set.



1/3 drawer format



**Models :**

- Citroën: Berlingo II, Berlingo III, C3 IV, C3 Aicross, C3 Picasso, C4 Cactus, C4 III, C4 Picasso, C4 Space Tourer, C5 Aircross

- Peugeot: 208 I, 208 II, 2008, 2008 II, 308 II, 3008 I, 3008 II, 5008, 5008 II, Partner

- Opel: Combo-E (X19), Combo-E Life (X19), Crosslande X (P17), Grandland X (A18), Corsa VI, Mokka II

- DS: 4, 3, 3 Crossback

- Toyota: Proace City



Delivered in a suitcase



### CAMSHAFT TIMING PIN TOOL PURETECH EURO 6.3 VERSION

OM 3798

On new versions of the 1.2L PURETECH EURO 6.3 engine, the manufacturer's recommendations stipulate that the camshaft previously fitted in place of the vacuum pump must be replaced by a new one.

**Applications:**

- Citroën: Berlingo II, Berlingo III, C3 IV, C3 Aicross, C3 Picasso, C4 Cactus, C4 III, C4 Picasso, C4 Space Tourer, C5 Aircross

- Peugeot: 208 I, 208 II, 2008, 2008 II, 308 II, 3008 I, 3008 II, 5008, 5008 II, Partner

- Opel: Combo-E (X19), Combo-E Life (X19), Crosslande X (P17), Grandland X (A18), Corsa VI, Mokka II

- DS: 4, 3, 3 Crossback

- Toyota: Proace City





MAZDA/SUZUKI/TOYOTA

1.2 PURETECH PETROL OIL  
CRANKCASE ALIGNMENT PLATE

OM 3796



CRANKSHAFT HOLDING TOOL

OM 3799



CRANKSHAFT SEAL ASSEMBLY TOOL  
1.0-1.2 PURETECH

OM 4142

Accessory of OM 3747/OM 4041/OM 3797



CAMSHAFT LOCK PIN

SA 3797

Spare part of OM 3797  
Accessory of OM 3747



STRETCH BELT INSTALLATION  
AND REMOVAL TOOL PSA

OM 4058

Accessory of OM 3797/OM 4041



Models:  
Peugeot: 108, 208, 301, 308, 408,  
2008, 3008, 5008, Partner  
Citroën: C1, C3, C3 Picasso, C3  
Aircross, C4, C4 Picasso, C4  
Cactus, C-Elysée, Berlingo, DS3,  
DS4, DS4 S, DS5 LS  
Opel: CrosslandX

**Engines:** PureTech 1.0, 1.2L from  
2012.



FEMALE CYLINDER HEAD  
SOCKET TYPE E12X140

OM 4552



BELT GAUGE PSA 1.0/1.2  
PURETECH

OM 4141

Spare part of OM 4041/OM 4058



**Peugeot:** 2008, 208, 308, 5008, 3008



## MAZDA/SUZUKI/TOYOTA

TN

### TIMING TOOLS BMW/ROVER/OPEL DIESEL WITH CHAIN DRIVE

OM 3858



1/3 drawer format



Delivered in a suitcase

**Models:**

BMW: 116 E81/82/87/88 (08-12), 118 E81/82/87/88 (04-14), 120 E81/82/87/88 (04-14), 123 E81/82/87/88 (07-14), 316 E90/91/92/93 (09-12), 318 Compact E46 (01-05), 318 E90/91/92/93 (05-12), 320 Compact E46 (98-05), 320 E90/91/92/93 (05-12), 325 E90/91/92/93 (02-14), 330 E46/90/91/92/93 (99-14), 335 E90/91/92 (06-11), 520 E39/60/61 (00-10), 525 E39/60/61 F10-11 (00-12), 530 E46/60/61 F10/11 (98-13), 530GT F07 (09-12), 535 E60/61 F10-11 (04-12), 535GT F07 (10-12), 635 E63/64 (07-11), 730 E38/65/66 F01/02/04 (98-12), 740 F01/02/04 (09-12), 740 xDrive F01/02/04 (09-12), X1 sDrive E84 (09-12), X1 xDrive E84 (09-14), X3 E83 (03-10), X3 xDrive E83 (08-12), X5 E53/70 (00-12), X5 xDrive E70 (10-13), X6 E71/72 (08-10), X6 xDrive E71/72 (10-14)

Mini: Mini (10-14), Clubman (10-14), Clubvan (12-14), Countryman (10-14), Paceman (13-14), Roadster (12-14)

Land Rover: Freelander TD4 (00-06), Range Rover TD6 (02-06)

Rover-MG: MG-ZT/T (01-05), 75 CDT/CDTI (99-05)

Opel: Omega B (01-03)

Toyota: Verso 1.6D4D

**Engines:** 1.6, 1.8, 2.0, 2.3, 2.5, 3.0, 3.5, 4.0 diesel



### TIMING TOOLS PSA/FORD/TOYOTA/OPEL 1.5 BLUEHDI / 1.4, 1.6 HDI

TN

OM 4105



**Models:**

Citroën: Berlingo III, C3 III, C3 Aircross, C4 Cactus, C4 Spacetourer, C5 Aircross, Berlingo III Van, Traveller, Jumpy

Mazda : 2, 3, 5

Peugeot: 208 II, 2008 II, 308 II, 308 III, 508 II, 3008 II, 5008 II, Rifter, Partner, Expert

Opel: Corsa (F) VI, Mokka, Crossland, Grandland, Combo, Combo Cargo, Zafira, Vivaro

Suzuki : Liane (RH), SX4 (RW)

Toyota: Proace City, Proace City Verso, Proace, Proace Verso

Engines : 1,5 Blue HDI





MERCEDES - SMART

TIMING TOOLS MERCEDES/CHRYSLER/JEEP  
PETROL-DIESEL DCI - CRD

TN

OM 9283

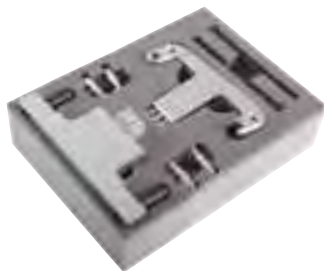

**Models:**

Mercedes: 190, 200, 300, 500, 208, 210, 600sl, 300sl, 308d, 500sl, 410d, 812, A160 CD, B180 CDI, B200 CDI, C180, C200D

Chrysler: PT Cruiser

Jeep: Grand Cherokee

**Engines:** 1.6, 1.8, 2.0, 2.1, 2.2, 2.2 CRD, 2.3, 2.5, 2.7, 2.7 CRD, 3.0, 3.2, 3.9, 4.0, 4.2, 5.0



CRANKSHAFT LOCKING TOOL  
PULLEY 0.9-1.2 TCe

TN

OM 5070



**Models:**

Dacia: Dokker, Duster, Lodgy, Logan, Sandero

Renault: Capture 2013>2019, Clio IV 2012>2019, Kadjar 2015>2018,

Kangoo II 2013+, Mégane III 2012>2017, Mégane IV 2016>2020, Scénic/Grand Scénic III 2012>2017, Scénic/Grand Scénic IV 2016>2018, Twingo II >2004

Smart: Fortwo, Forfour 2014>2019

Engines : 0.9, 1.2 TCe



TIMING TOOL SET 1.3 TCe

TN

OM 3697



1/3 drawer format



Delivered in a suitcase

**Models:**

Renault: Arkana (XJC) (19-), Capture (J87) (13-19), Captur II (XJB) (19-), Clio V (XJA) (19-), Kadjar (HFE), Koléos II (HZG) (17-),

Mégane IV (BFB/KFB/LFF) (16-), Scénic/Grand Scénic IV (JFA/RFA) (16-), Talisman (KFD/LFD)(15-).

Mercedes: A-Class (177) (18-), B-Class (247) (19-), CLA Coupe (118) (19-), CLA S/Frein (118) (19-), GLA (247) (20-), GLB (247) (19-).

Nissan: Qashqai (J11) (14-), X-Trail (T32)(14-).

Dacia: Dokker (F/K67), Plumeau (HJD) (17-), Lodgy (J92).

Engines : 1.3 TCe



TOOLS DACIA NISSAN MERCEDES  
0.9-1.6 ET 1.3 TCe ENGINE WHEEL  
BLOCKING

TN

OM 4160



**Models :**

- Dacia : Dokker (2019), Duster (2018), Lodgy (2019), Logan (2013), Sandero (2013)

- Mercedes : Classe A (2018), Classe B (2019), CLA (2019), GLA (2019), GLB (2019)

- Nissan : Qashqai (2018), X-Trail (2018)

- Renault : Arcana (2019), Captur (2018), Clio V (2019), Kadjar (2018), Megane IV (2017), Scenic/Grand Scenic (2018), Talisman (2018)



CHAIN RIVET EXTRACTOR

TN

OM 4150



**Specifications:**

- frame opening: 42mm
- rivet removers length: adjustable up to 25mm
- 22 and 14mm hexagonal drive

**Contents:**

- chain breaker
- 4 chain breaking tips: 3, 3, 4, 5mm
- 1 chain rivet tip
- 2 assembly plates





# OPEL - VAUXHALL

## MASTER TIMING TOOL SET OPEL/CHEVROLET/SAAB/ FIAT/LANCIA/SUZUKI/FORD

TN

OM 6500

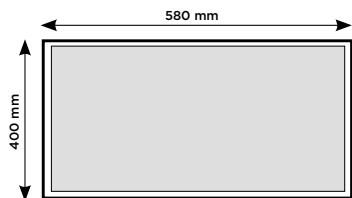

Cabinet drawer size



Retail components available on [clas.com](http://clas.com)

**Models:**

Opel: Corsa B,C, Combo, Tigra, Agila,Tigra B, Meriva, Astra F,G, H, Astravan ,Speedster/VX220, Zafira A , B, Vectra B , C, Signum, Omega B, Sintra, Frontera A , B , Astravan, Kadett, Ascona, Omega, Monterey, Antara ,Croma ,Speedster/VX220  
 Chevrolet/Daewoo: Epica, Captiva, Nubira, Lacetti, Evanda  
 Saab: 9-3, 9-5 (98-04)  
 Alfa: 145, 146, 147, 156, 159, 166, GT, Crosswagon Q4  
 Fiat: Punto, Grande Punto, Bravo/Brava, Marea, Weekend, Stilo, Doblò/Cargo, Multipla, Idea, Panda  
 Lancia: Ypsilon, Musa, Lybra, Thesys  
 Suzuki: Ignis, Swift, Wagon R+  
 Ford: Ka

**Engines:** 1.0 12V, 1.0 16V, 1.2 16V, 1.4 1.6, 1.2-1.4 16V (Chain), 2.0, 2.0 Turbo, 2.2 DI, 2.0-2.2 16V, 1.6 16V, 1.8 16V, 2.0 16V, 2.2 16V, 1.3 JTD MultiJet, 1.3 CDTI, 1.3 TDCl, 1.6 MultiJet, 1.9 JTD, 1.9 MultiJet, 2.4 JTD, 1.9 CDTI, 2.0 MultiJet,1.5 D, 1.5 TD, 1.7 D, 1.7 TD, 1.6-1.7 D, 3.0 TD, 3.1 TD, 2.0-2.2-2.4 TD, 2.0-2.2 DI, 2.0 TDCI, 2.0 D VCDI, 2.2 16V (double camshaft)



## COFFRET CALAGE OPEL/ VAUXHALL 1.0-1.2-1.4 TURBO

TN

OM 4214



1/3 drawer format

**Models :**

Adam, Ampera, Astra-J, Aveo, Corsa-D, Insignia, Meriva-B, Mokka, Zafira-C Tourer  
 Engines : 1,0, 1,2, 1,4

**Contents:**

- camshaft sensing disc adjustment tool
- input camshaft adjustment tool
- camshaft sensor locator tool
- chain tensioner pin 4 mm
- Belt tension pin 2.5 mm
- camshaft lock plate
- crankshaft locking pin



Delivered in a suitcase







OPEL - VAUXHALL

TN

TIMING TOOLS 1.3L HDI - JTD -  
 MULTIJET - TDCI - CDTI

OM 4012



**Models:**

Alfa: 145, 146, 147, 156, 159, 166, GT, Crosswagon Q4  
 Fiat: Punto, Grande Punto, Bravo/Brava, Marea, Weekend,  
 Stilo, Doblò/Cargo, Multipla, Idea, Panda, Ducato  
 Lancia: Ypsilon, Musa, Lybra, Thesis  
 Opel: Corsa, Agila, Meriva, Combo Tour, Astra, Zafira,  
 Vectra  
 Suzuki: Ignis, Swift, Wagon R+  
 Ford: Ka  
 Jeep: Renage  
 Citroën: Nemo

**Engines:**

1.3 JTD MultiJet, 1.3 CDTI, 1.3 TDCI, 1.6 MultiJet, 1.9 JTD, 1.9  
 MultiJet, 2.4 JTD, 1.9 CDTI, 2.0 MultiJet



TIMING TOOLS RENAULT/OPEL/  
 NISSAN/SUZUKI DCI

OM 3674



**Models:**

Renault: Clio, Kangoo, Laguna, Espace, Master, Mégane/  
 Scénic, Trafic  
 Nissan: Kubistar, Interstar, Qashqai  
 Opel: Vivaro, Movano  
 Suzuki: Grand Vitara

**Engines:** 1.5 DCI, 1.9 TD, 1.9 DCI, 2.2 DCI, 2.5 DCI



TIMING TOOLS OPEL 1.6 CDTI

OM 4121



**Models:**

Opel / Vauxhall: Astra J, Meriva B, Mokka,  
 Zafira C, Zafira Tourer  
 Engine: 1.6 ecoFLEX CDTI





## OPEL - VAUXHALL

### TIMING TOOLS FIAT 2.3 JTD

TN

OM 4025



**Applications:**

- Citroën : Jumper
- Fiat : Ducato
- Opel : Arena, Movano
- Peugeot : Boxer
- Renault : Mascott, Master, Trafic
- Vauxhall : Movano

**Engines:** 2.5D, 2.5DCI, 2.8DCI, 2.8JTD, 2.8HDI



### TIMING TOOLS FIAT/ALFA/LANCIA/OPEL

TN

OM 4036



**Models:**

- Alfa: 145, 146, 147, 156, 166, GT
- Fiat: Punto, Grande Punto, Brava/Bravo Marea, Weekend, Stilo, Doblo/Cargo, Multipla, Ducato
- Lancia: Lybra, Thesys
- Opel: Vectra, Zafira, Astra, Insigna, Signum

**Engines:** 1.6 MultiJet, 1.9 JTD, 1.9 MultiJet, 2.4 JTD, 1.9 CDTI, 2.0 MultiJet



### TIMING TOOL RENAULT/NISSAN/OPEL

TN

#### 1.6-2.0-2.3 DCI-CDTI

OM 3686



1/3 drawer format

**Models:**

- Fiat: Talento 2
- Renault: Megane, Scenic, Laguna, Latitude, Fluence, Espace, Trafic, Koleos, Vel Satis
- Nissan: Primastar, Qashqai, X-trail, NV 400
- Opel: Vivaro, Movano
- Mercedes: C180

**Engines:** 1.6, 2.0, 2.3 DCI et CDTI



Delivered in a suitcase





VOLVO

TN

## TIMING TOOLS SET FORD/VW/SEAT/ VOLVO/MAZDA

OM 4056



### Models:

Ford: B-MAX, C-MAX, Courier, EcoSport, Edge, Escort, Fiesta, Focus, Focus C-Max, Fusion, Galaxy, Grand C-MAX, Grand Tourneo Connect, Kuga, Mondeo, S-MAX, Tourneo Connect, Transit Connect  
 Mazda: 2 (DY)(02-07), 3 (BK)(03-09), 3 (BL)(09-14), 5 (CR), 5 (CW), 6 (GG/GY)(02-07), 6 (GH)(07-13), CX-7 (ER)(07-13), MPV (LW)(99-05), MX-5 (NC)(05-15), Tribute (EP)(01-06)  
 Volvo: C30, S40, S80, V50, V70  
 Peugeot: 307, 308, 407, 508, 807, Expert  
 Citroën: C4, C5, Jumpy  
 VW: Sharan  
 Seat: Alhambra  
**Moteurs :**  
 1.4, 1.6 16V, 1.7, 1.8 16V, 2.0 16V, 2.3, 2.5 (également Zetec)  
 1.4, 1.6, 1.8, 1.9, 2.0, 2.2 D/TD/TDCi



## TIMING TOOL SET FORD 1.6 ECOBOOST 1.8-2.0 DURATEC VOLVO 1.6

OM 5016



1/3 drawer format



### Applications:

- Ford: B-MAX (>2010), C-MAX (2003>2012), Fiesta (>2013), Galaxy (>2010), Focus (2004>2015), Grand C-MAX (>2010), Kuga (>2013), Mondeo (>2010), S-MAX (>2010), Tourneo Connect (>2013), Transit Connect (>2013)  
 - Volvo: S60 Cross Country T4 (2011>2015), S80 GTDi T3 (2010>2015), V40 GTDi T4 (2012>2015), V60 GTDi T4F (2011>2015), V70 T2/T3/T4 (2010>2015)

### Engines:

Volvo: 1.6 gtdi  
 Ford: 1.6 SCTi / Ti-VCT Ecoboost petrol  
 Ford: 1.8 Duratec-HE petrol M14  
 Ford: 1.8 Duratec-SCI petrol  
 Ford: 2.0 Duratec-HE petrol



Delivered in a suitcase





# TIMING BELT

## MECHANICAL TENSION GAUGE (in NEWTONS)

TN

OM 3494

For checking toothed timing belts and accessory belts. This tension gauge can also be used on K4 K5 K6 belts, alternators, aircon compressors, steering assisted, fans.

Mandatory manufacturer data in Newtons



## CHAIN RIVET EXTRACTOR

TN

OM 4150

Allows for separation and reassembly of timing chains on most vehicles, transmission chains on quads and motorcycles...

### Specifications:

- frame opening: 42mm
- rivet removers length: adjustable up to 25mm
- 22 and 14mm hexagonal drive

### Contents:

- chain breaker
- 4 chain breaking tips: 3, 3, 4, 5mm
- 1 chain rivet tip
- 2 assembly plates



## DIGITAL STROBE LIGHT

TN

AC 5048

The strobe lamp is connected to a candle wire via an induction sensor. It produces a flash synchronized with the ignition point. This powerful flash, directed at the ignition marks engraved on the flywheel rim or damper pulley, "freezes" the position of these marks in relation to the fixed index, making it easy to check whether the ignition advance setting is correct or not. The exact ignition point can therefore be set with great precision by varying the phase shift from the device.

**+** Integrated phase shifting

CAUTION: The exact parameters for setting the Engine's ignition timing are usually found in the manufacturer's technical manual.

