

2024 - 2025

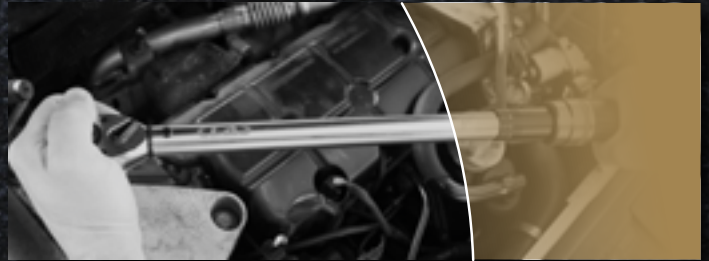

**CLAS**<sup>®</sup>  
GLOBAL GARAGE SOLUTIONS

*Solutions*  
**BODY REPAIR**



# 467

## BODY REPAIR

Browse through our BODY REPAIR solutions, from our 24-25 general catalog.



**470** - HEADLIGHTS



**473** - AUTO GLASS



**484** - BODYWORK HANDLING



**489** - BODYWORK LIFTING



**491** - BODY REPAIR TOOL CABINET



**492** - WELDING & CUTTING



**493** - PULLING & RESTRAINING

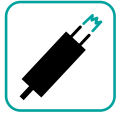

**499** - PLASTIC REPAIRING



**502** - BODYWORK PAINTING



**507** - DOORS & CABIN



**508** - BODYWORK STAPLES

You can find our full range on **clas.com** (or in our general catalog)





# CHOOSE YOUR HEADLIGHT ADJUSTER PROPERLY.

## Points to watch

Before choosing a headlight adjustment device, there are several questions to ask yourself:

- What type of vehicle am I likely to be working on? LV, LCV, HGV, motorcycle?
- How often do I use it?
- do I have a dedicated place in my workshop for this service, and does my location meet the requirements, or do I need to clear the area accordingly? (e.g. laying a rail if it's not flat).

## The different types of light in an optical compartment :

- halogen light
- xenon light
- LED light
- laser light
- "intelligent" light



## LEARN MORE

### MATRIX - DLA - ILS : Added segments

The evolution of headlights has led automobile manufacturers to create lighting modules with different construction characteristics.

The projections established by current regulations remain unchanged (low, high and fog lights), but a fourth projection must be controlled depending on the vehicle manufacturer.

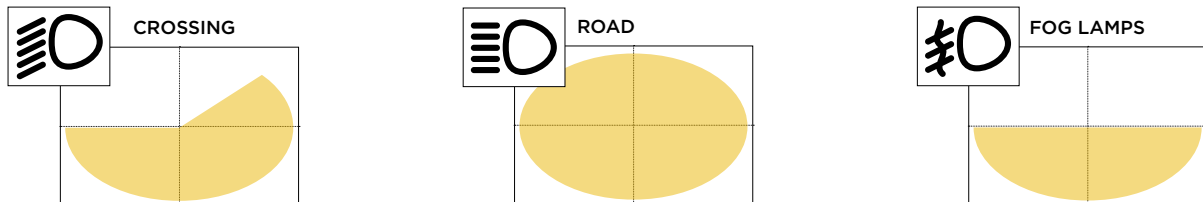

### Adjustment: diagnostics takes over

If segments have been added to the vehicle, the prerequisite for adjusting and checking the position is to connect to the control unit via diagnostics at the OBD socket and set the adjustment mode. the reference parameters for adjusting the segments to be added are defined by the car manufacturer and the vehicle being tested. any operation carried out on the phrases without connecting to diagnostics will be cancelled when the vehicle is started up.

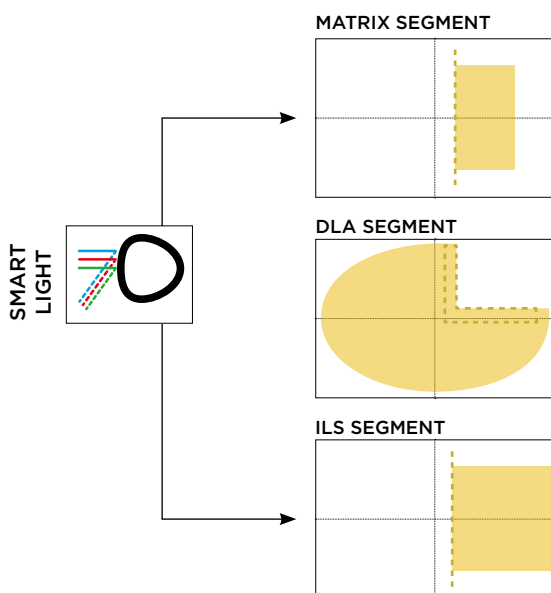

### Update 2020: new segments!

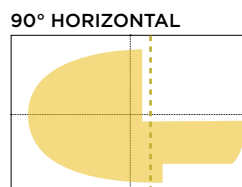
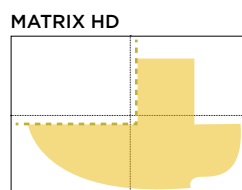

With the evolution of cars, and indeed of their headlamps, new segments have recently appeared, and our AC 3010 headlamp adjuster will enable you to adjust them.

*Reminder: the headlamp needs to be updated annually. If you purchased your device before 2020, these new segments will be available with the update.*



## COMPARATIVE OVERVIEW



REF	AC 2005BL	AC 2013	AC 3010
Vehicle type			
Intensity of use			
Aligner	Mirror	Double laser	Double laser
Beam reading	Sight	Sight	Camera
Digital luxmeter	Yes	Yes	Yes
Power supply	9V battery	1.5V x3 + 9V battery	12V battery
Light type	Halogen, Xenon, Led	Halogen, Xenon, Led	Halogen, Xenon, Led, <b>Matrix led, Laser</b>
Screen type	Digital	Digital	5.7° color LCD touchscreen
Optional rail	No	Yes	Yes





# HEADLIGHT ADJUSTMENT

## STANDARD HEADLIGHT ADJUSTMENT DEVICE

TN

AC 2005BL

**B.LINE**  
BUDGET SOLUTION

**Functions:**

- control and measurement of the closing mechanism 0-4%
- control of the lateral adjustment  $\pm 5\text{cm}/10\text{m}$
- measurement of the illumination intensity 0-150klux/1m, 0-240lux/25m
- intervention on headlights (xenon, halogen, LED...), anti-fog

**Specifications:**

- mirror type aligner
- digital luxmeter
- alu column (collapsible) graduated from 20 to 150cm
- sliding regulating mechanism
- metal housing with tilt adjustment
- power supply: 9V battery (supplied)
- dimensions: L.712xW.580xH.1810mm



## DUAL LASER HEADLIGHT ADJUSTMENT DEVICE

TN

AC 2013

**Functions:**

- control and measurement of the closing mechanism 0-4%
- control of the lateral adjustment  $\pm 5\text{cm}/10\text{m}$
- measurement of the illumination intensity 0-150klux/1m, 0-240lux/25m
- intervention on headlights (xenon, halogen, LED...), anti-fog

**Specifications:**

- laser-type aligner (SA2037) compliant with standard EN 60825
- digital luxmeter
- alu column (collapsible) graduated from 20 to 150cm
- sliding regulating mechanism
- thermoplastic housing with tilt adjustment
- laser aligner power supply: 3 1.5V batteries (supplied)
- dimensions: L.712xW.580xH.1810mm
- UTAC NFR 63801 standard



**+** Precise laser adjustment to the optics





TN

## DUAL LASER/CAMERA HEADLIGHT ADJUSTER

AC 3010

- checks and carries out automatic diagnostics of dipped, full beam and anti-fog beams regardless of the type of headlight: LED (Matrix, Intelligent...), xenon, halogen...
- allows the beam to be checked and automatically measured (using a camera) when lowered and in lateral mode. It also allows you to measure the illumination intensity.
- centering of the housing using cross-form lasers.
- conforms to the standard UTAC NFR 63-801

**+** No misinterpretation



Flash to watch the video!



### Specifications:

- measuring range:  
 Top and bottom alignment 0-6% (accuracy +/- 0,1%)  
 Right and left alignment 0-10% (accuracy +/- 0,2%)
- light intensity: 150kcd
- 360° rotating aluminum column
- counterweight upward and downward motion
- 3-axis inclinometer compensating for irregularities in the ground electronically
- adjustable castors compensating for significant differences in ground levels
- housing height sensor
- ICD color tactile 5.7» screen
- integrated printer: Registration number/date/test result
- 12V rechargeable battery
- automatic standby
- simple and quick software updates (using a USB key)
- connections: RS232
- communication protocol: Net1, Net2
- dimensions: L.695xI.660xH.1780mm

## OPTIONAL

DUAL LASER/CAMERA  
 HEADLIGHT ADJUSTER SET-UP

SA 9924

HEADLIGHT CALIBRATION AC  
 2013/AC 3010 HEADLIGHT RULE

SA 9925

TP

NO WARRANTY

2 WARRANTY





# HEADLIGHT RESTORATION

## 3" MINI POLISHER KIT Ø75mm

TN

OP 1429



**Specifications:**

- speed: 3,200rpm
- pad size: 75mm
- spindle thread: M6x100
- air consumption: 170l/min
- length: 115mm

SA1429 : velcro sanding pad Ø75mm

Connector supplied



## VARNISH SPRAY 1K 400ml

TN

CO 1004

Enables varnishing and protecting topcoats while providing a high-gloss finish.  
 Excellent for body parts (hoods, doors, fenders, rocker panels, rims, etc.).  
 Transparent, UV and scratch-resistant.



**+** Respect for colorimetry

Also available in box of 12





# GLASS REPAIRING

## WINDSHIELD REPAIR KIT

TN

EG 9988

The Contents can be used to fit and remove bonded or beaded windscreens, as well as to repair impact damage.

You can work in different ways:

- with the cutting knife, using manual traction
- with single- or 2-operator ropes

The servo unit is ideal for creating a windshield-dedicated business, with an ergonomic, all-in-one workstation.



**Contents :**

- EG0086 : 6-drawer trolley
- drawer 1 conventional hand tool
  - OS3200: 1/4" ratchet insert
  - OS3000 : 1/2" ratchet insert
  - OS 4020 combination wrench insert
- drawer 2
  - EG1101BL : screwdriver insert
- drawer 3
  - OC1409 : dashboard protectors 4pieces
  - OC 2204 universal rain/headlight sensor gel x5
  - OC5071 : cartridge gun
- Drawer 4 Windshield Cutting Inserts OC3351
  - SA9987: Windshield Cutting Foam Insert
  - OC0302: Scraper and Cutter Set
  - OC0200 : Gasket Cutting Knife
  - OC7025: Box of 5 25mm Blades
  - OC7038: Box of 5 38mm Blades
  - OC2900: Pair of Pull Handles
  - OC2100: Braided Wire Reel
- OC3100: square wire feeder
- OC6000: Wire Locking Lever
- OC4100: Wire Passing Tool
- OC0304: Handle Scraper
- OC5497: 100pc Trimmer Blades
- Drawer 5 Windshield Intervention Insert OC3352
  - OC0501: Rope Insertion Tool
  - OC0502: Windshield Mounting Tool
  - OC8078: 5-piece Nylon Spatula Kit
  - OC1700 : Wiper Blade Remover
  - EG0002 : Washer Nozzle Cleaning Tool
  - OC0600: Pair of Suction Cups
  - OC3350 : Angled Round Butt Joint Tool
- Drawer 6
  - OC2203 : Windshield Repair Kit
  - OC8067 : Carbide Bit
- side storage
  - EG8001 : Metal Workshop Bin
  - OC3360 : 50m Adhesive Film







# GLASS CUTTING

## INSERT WINDSHIELD CUTTER

TN

OC 3351

Complete glazing cut-out insert



2  
WARRANTY

## GLAZING INTERVENTION INSERT

TN

OC 3352

Complete insert intervention glazing



2  
WARRANTY

## ADHESIVE FILM GLASS PROTECTION TRANSPARENT 500x60cm 0.75mm

TN

OC 3360



NO  
WARRANTY





**HOLLOW STARTING NEEDLE** TN  
 OC 4500

**NO WARRANTY**

**WIRE THREADER** TN  
 OC 4100

**NO WARRANTY**

**WIRE GUIDE** TN  
 OC 6000

75mm length of flat side

**NO WARRANTY**

**SAWING WIRE** TN  
 0.8mmx0.8mmx44m  
 OC 2100

**Specifications:**  
 • resistance: 110kg / 1078N

44 m **NO WARRANTY**

**TRIANGULAR WIRE REEL 50m** TN  
 OC 3401

50 m **NO WARRANTY**

**SQUARE CUTTING WIRE** TN  
 0.7mmx0.7mmx44m  
 OC 3100

**Specifications:**  
 • resistance: 95kg / 931N

44 m **NO WARRANTY**

**KIT OF 4 WINDSCREEN PROTECTORS** TN  
 OC 1409

**NO WARRANTY**

**PAIR OF PULLING HANDLES** TN  
 OC 2900

Quick-lock handles

**2 WARRANTY**

**2-HANDLE LINE CUTTER KIT** TN  
 OC 1500

A set of 2 handles allows to pull the inserted wire in the joint with the help of a needle.

**Contents:**  
 • OC4500: hollow leader needle  
 • OC2100: braided wire reel 0.8mmx0.8mmx44m  
 • OC2900: pair of grip pull handles

44 m **NO WARRANTY**





TN

### WINDSCREEN REMOVAL KIT

OC 1401

Central suction cup with spring-loaded return lever mounted on swiveling arm.

The device replaces the second technician to pull the wire to be cut inside the vehicle, fixed with the suction cup in the center of the windshield, the spring system pulls the wire step by step while the technician pulls the wire from outside.

**Contents:**

- OC4500: hollow leader needle
- OC2100: braided wire reel 0.8mmx0.8mmx44m
- OC 2900: pair of Grip Pull Handles
- OC1399: spring-loaded suction cup

**+ 1 single operator**



**44 m**

TN

### RATCHET WINDSHIELD CUTTER

OC 6498

Accessory of OC 2900/OC 4500/OC 0600/OC 0200/OP 0500/OP 0714/OP 5060/OC 2100/OC 3100/OC 3401/OC 1100

This single suction cup kit with pump allows, thanks to the nylon thread, to remove the windcreens without damaging the gaskets, so it is not necessary to disassemble them. The gasket is cut by pulling a wire (or cable) operated by a ratchet system. This suction cup, due to its small size, allows you to work on the windcreens, rear windows and the side panels of a vehicle. Easy to use, it allows a quick intervention (a few minutes) by a single operator and without any physical effort.

This tool has been certified by a large number of car makers.

**+ 1 operator and effortless cutting**



**Specifications:**

- universal: compatible with nylon and steel wire (all types: braided, square and triangular)
- traction capacity 200kg (compared to 100kg for steel cable)
- up to 8 cuts before changing the nylon thread

**Contents:**

- mono suction cup cable traction system with ratchet
- OC4100: windscreen line inserter
- nylon wire drawer 25m
- protective glasses

**2**  
WARRANTY

### NYLON WIRE DRAWER 50m

OC 1100



**50 m**

**NO**  
WARRANTY



TN

## MOTORIZED WINDSHIELD CUTTING KIT

OC 1402

Electrically assisted cutting system on all types of windshields by a single operator.

This tool allows you to work alone and without effort thanks to its electric assistance system. It cuts all types of windshields efficiently and effortlessly.

It is thus possible to remove "encapsulated" windows (windshield, window, quarter glass) without damaging the seal or the support.

The risks of touching the window and the various trimmings are reduced, guaranteeing a fast, precise and especially effortless work thanks to the 12V motor to be coupled to the vehicle's power supply. Moreover, thanks to its wireless remote control, the operator keeps control of all the cutting steps, both inside and outside the vehicle.



No effort when cutting



**Contents:**

- motor equipped with its suction cup, powered by a standard plug (cigarette lighter 12v, length 1.7m) supplied
- wireless remote control (for viewing and controlling wire tension)
- suction cup with attachment hook (to be positioned outside the window)
- suction cup with return pulley (to be positioned inside the vehicle)
- nylon thread spool



## HAND CUTTER FOR WINDSCREEN CUTTING

OC 0200

Ergonomic sheathed knife for cutting the windshield seal by pulling the blade.

**Specifications:**

- grooved metal
- t-shaped handle, hose



Supplied with 25mm blade



OC 7025	25mm BLADE SET (5 PCS)
OC 7038	38mm BLADE SET (5 PCS)



## PNEUMATIC KNIFE

OP 0500

- oscillations/min: 20000
- length: 192mm
- supply pressure: 6.2bar
- consumption: 113l/min
- net weight: 1kg



Supplied with connector and 1 OP0557 blade

OP 0557	STRAIGHT BLADE 57mm	Spare part of OP 0500
OP 0535	STRAIGHT BLADE 35mm	Accessory of OP 0500
OP 0508	SCRAPER BLADE 8mm	Accessory of OP 0500
OP 0590	STRAIGHT BLADE 90mm	Accessory of OP 0500
OP 0536	U-SHAPED BLADE 36mm	Accessory of OP 0500

OP 0536

OP 0535

OP 0557

OP 0508

OP 0590

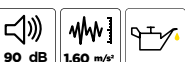



### ROPE INSERTION TOOL

TN

OC 0501



Length of the insertion rope: 6m



For unglued windshields.



### WINDSCREEN GASKET ROLLER TOOL

TN

OC 0502

With its selection of ends, it allows you to position the gasket.



For unglued windshields.



### RETRACTABLE SCRAPER

TN

OC 0305

### RETRACTABLE SCRAPER + 100 BLADES

OC 0306

OC0305 : 1 x retractable scraper  
OC5497 : 1 x 100 scraper blade set

Blade width: 38mm  
Blade height: 19mm



### WINDSHIELD GASKET TOOL ROUND END ELBOW

TN

OC 3350

Round-ended hook for cleaning broken glass.



### SCRAPER AND UTILITY KNIFE SET

TN

OC 0302



#### Contents:

- 1 cutter
- 5 straight blades 12mm (OC5301)
- 5 straight blades 16mm (OC5302)
- 5 straight blades 20mm (OC5303)
- 5 bevelled blades 16mm (OC5304)
- 5 trapezoidal blades (OC5305)



### SCRAPER WITH HANDLE + 100 BLADES

TN

OC 0303



Blade width: 38mm  
Blade height: 19mm

OC0304 : 1 x scraper with handle  
OC5497 : 1 x 100 scraper blade set



OC 0304 SCRAPER WITH HANDLE



### UNIVERSAL GEL FOR ATTACHING RAIN SENSOR/LIGHT SENSOR (single dose)

TN

OC 2204



### 100 WINDSCREEN PREPARATION TOOL SET

TN

OC 0301





**PNEUMATIC GUN FOR 370mm CARTRIDGES AND BAGS**

**OP 5060**

For silicons, glues, putties application with 310ml cartridges and 300,400 and 600ml bags.

**Specifications:**

- aluminum body and ring
- total length: 470mm
- length: 370mm
- height: 270mm
- sound level: 80dB
- air pressure inlet regulator from 4 to 8bar (10bar maximum) with 1/4" connection
- valve strength: 160kgf to 8bar
- progressive trigger to enable speed control

**+** Precise cable with the regulator



Supplied with 1 plastic spout SA5065



**CARTRIDGE AND BAGS GUN 340mm 12:1**

**OC 5071**

For the application of silicons, adhesives and putties in 310ml cartridges and 300 and 400ml bags.

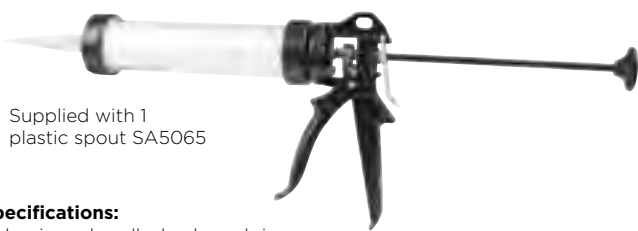

Supplied with 1 plastic spout SA5065

**Specifications:**

- aluminum handle, body and ring
- ratio: 12:1
- max. thrust: 4000Nm
- total length: 340mm



**AIR CAULKING GUN**

**OP 5061**

For the application of silicons, glues and putties with 310ml cartridges.



Connector supplied

**Specifications:**

- aluminum body
- total length: 325mm
- 1/4" connection
- supply pressure: 5bar
- progressive trigger to enable speed control



**12 CRIMPING NOZZLES 6-12mm Ø15x1,5mm L.100mm**

**CO 1050**



Output waist width: adjustable from 6 to 12 mm  
Adjustable deformation from 0 to 9 mm  
Possible cutting right side/left side

**12 V-SHAPED NOZZLES 10mm Ø15x1,5mm L.58mm**

**CO 1052**



**TAPERED NOZZLES Ø15x1,5mm L.105mm**

**CO 1056**



**SCREEN ADHESIVE CARTRIDGE 290ml**

**CO 1041**

Permits adhesion of screens, rear windows, side windows etc.

**Specifications:**

- MS polymer
- integrated primer
- application width 10 to 14mm
- drying: 2 hours at heart (at 20°C)
- hardness: SHORE 60

**+** Use without primary



**NOTE**

Electronic leak detection stethoscope p.482



Also available in box of 12





# WINDSCREEN REPAIR

## WINDSCREEN WIPER REMOVER

TN

OC 1700BL

Technique for covering all axes of support with a highly effective force ratio.  
4 different mountings. For approx. 100 brushes.

**B.LINE**  
BUDGET SOLUTION

**+** Small size

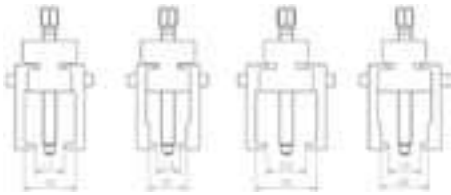

## WINDSCREEN WASHER NOZZLE CLEANING TOOL

TN

EG 0002



### Specifications:

- dimensions:  
950mm with protective cap  
870mm without protective cap
- tool diameter: 6mm
- cleaning needle and tracer needle: 0.5mm
- needle length: 13mm



## UNIVERSAL WINDSCREEN WIPER EXTRACTOR

TN

OC 1710



Telescopic adjustment of the thrust bolt.



### Contents:

- 4 cage extractors Ø26-30mm/Ø31-35mm/Ø36-40mm/Ø36-46mm, internal 45mm, hexagonal drive 12mm
- 1 extractor with internal grips 18-40mm, internal 45mm, hexagonal drive 12mm





★ **TOP PRODUCT**

**WINDSCREEN REPAIR KIT**

OC 2203

**+** Easy to use



**Contents:**

- SA4104: Battery-powered 12V UV lamp
- OC2202: Repair resin 10ml, yellow cap
- OC8064: Finishing resin 10ml, blue cap
- SA4108: 1 polish
- SA4109: 1 suction cup gel
- SA4105: 1 box of UV sheets
- SA4107: 1 inspection glass
- 1 scratching pencil
- SA4106: 1 injector holder
- OC2205x2: injectors
- 1 box of 10 blades
- 1 user's manual

**2**  
WARRANTY

**INJECTOR**

OC 2205

Spare part of OC 2203



**NO**  
WARRANTY

**REPAIR RESIN 10ml**

OC 2202

Repair resin 5 ml, yellow cap



**10**  
ml

**NO**  
WARRANTY

**FINISH RESIN 5ml**

OC 8064

Spare part of OC 2203



**5**  
ml

**NO**  
WARRANTY

**CARBIDE BIT Ø1mm**

OC 8067



**NO**  
WARRANTY

**ADHESIVE FILM GLASS PROTECTION  
 TRANSPARENT 500x60cm 0.75mm**

OC 3360



**NO**  
WARRANTY







### WINDSHIELD IMPACT SELF-REPAIR KIT

OC 2210

This tool allows the semi-automatic injection of roughing and finishing resins for "repairable" impacts.

Indeed, thanks to its 12V motorization (to be connected directly to the cigarette lighter), the compressor will first create a vacuum cycle before injecting the different resins. The multiple pressure and vacuum cycles will then allow the resin(s) to penetrate well in order to achieve a quick and durable repair.

The 12V UV curing lamp supplied in the kit will allow the resin to dry automatically thanks to its integrated timer. This intervention will thus avoid the aggravation of the impact (or the crack) to avoid the complete replacement of the glazing.

**+** Quality and speed of intervention.



**Contents:**

- metal support equipped with a strong suction cup + 2 others
- 12V pressure/depression compressor
- UV3 Leds lamp 12V
- 12V power cord (cigarette lighter type)
- air hose 1.5m
- mirror



### ELECTRONIC STETHOSCOPE LEAK DETECTOR

AC 5028

The electronic stethoscope allows you, simply by touching with the tip during static testing, to transmit the sound made by the target through headphones to locate engine pinging, bearing noise, slapping, etc.

It also lets you detect air leaks normally imperceptible by the human ear by making the ultrasounds made by an airflow audible.



**Specifications:**

- can be operated with 2x9V batteries (6f22 type) or equivalent
- response frequency: 36000Hz to 44000Hz
- operating temperature: 0°C to 40°C
- storage temperature: -10°C to 50°C
- weight: amplifier 183g/transmitter 156g

**Contents:**

- amplifier 176x84x35mm
- ultrasonic transmitter 170x84x36mm
- headphones
- alu stethoscope probe 250mm
- plastic amplifier tube 270mm
- carrying case with foam





## GLASS HANDLING

### PAIR OF SUCTION CUPS Ø115mm

OC 0550BL

Essential for positioning and gluing all kind of windscreens.

**Specifications:**

- tilting suction cups to adapt to various glass contours
- lever lock
- carrying handle
- capacity: 60kg
- suction cups Ø115mm
- supplied with fast-ratchet sling
- sling length: 4.7m
- sling length: 2.5cm



**B.LINE**  
BUDGET SOLUTION



**60 KG**

TN

### PAIR OF SUCTION CUPS Ø120mm

OC 0600

Essential for positioning and gluing all kind of windscreens.

**Specifications:**

- swappable suction cups to suit various glass shapes
- lever lock
- carrying handle
- capacity: 120kg
- suction cups Ø120mm
- supplied with fast-ratchet sling
- sling length: 5m



**+ Working comfort**

**Contents:**

- SA6958: Ø120mm suction cups
- SA6959: 5m strap with pawl



**120 KG**

TN

### 6 BODYWORK SUCTION CUP SET Ø85mm

OC 0667

**Specifications:**

- suction cup Ø85mm
- stand L.180mm
- holding width: 50mm
- bearing surface width: 80mm
- height of the stand adjustable to 32mm
- material: polyethylene and rubber
- adjustment using thumb screw system.



**NO WARRANTY**

### PUMP SUCTION CUP HGV Ø254mm CAPACITY 140kg

OC 0662

Vacuum pump with brass piston



**140 KG**

TN

## ★ TOP PRODUCT

### PAIR OF SUCTION CUPS Ø140mm

OC 0611

**+ Increased security**

**Specifications:**

- tiltable suction cups to adapt to different window shapes
- locking by lever
- Handling grip
- capacity: 120kg
- suction cups Ø140mm



Suction cup Ø140mm

**120 KG**

TN



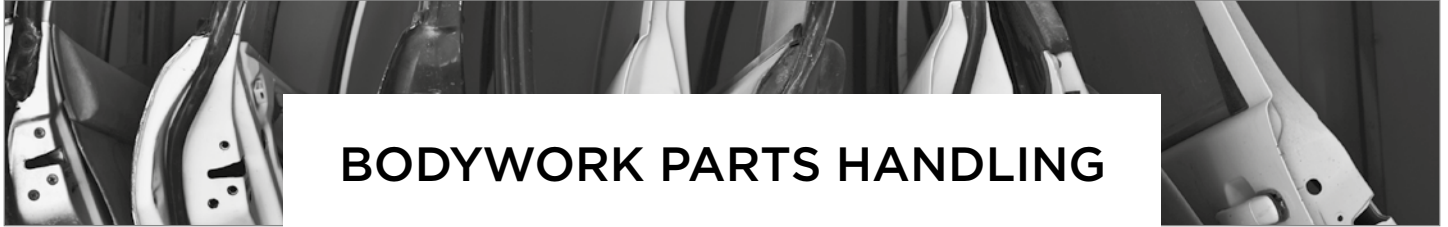

# BODYWORK PARTS HANDLING



## TOP PRODUCT

TN

### BODYWORK STAND WITH TARPAULIN

OC 0724

This multifunctional folding mobile easel is ideal for all bodywork and glazing work.

Equipped with a tarpaulin to hold tools or other items, it can also be used to protect parts such as hoods, bumpers, wings, etc...

**+** Foam protection



#### Specifications:

- capacity: 270kg
- folding galvanized steel structure (Ø32mm x 1.2mm).
- height: 1040mm
- width: 1080mm
- working range from 680 to 1040mm (adjustable feet)
- PU support plug
- weight: 6.4kg



### ADJUSTABLE BODYWORK STAND WITH TOOL HOLDER

TN

OC 0713

Specially designed foldable trestle to support the bodywork parts (bonnet, door, bumpers...etc.)

Integrated tool tray  
6-position setting

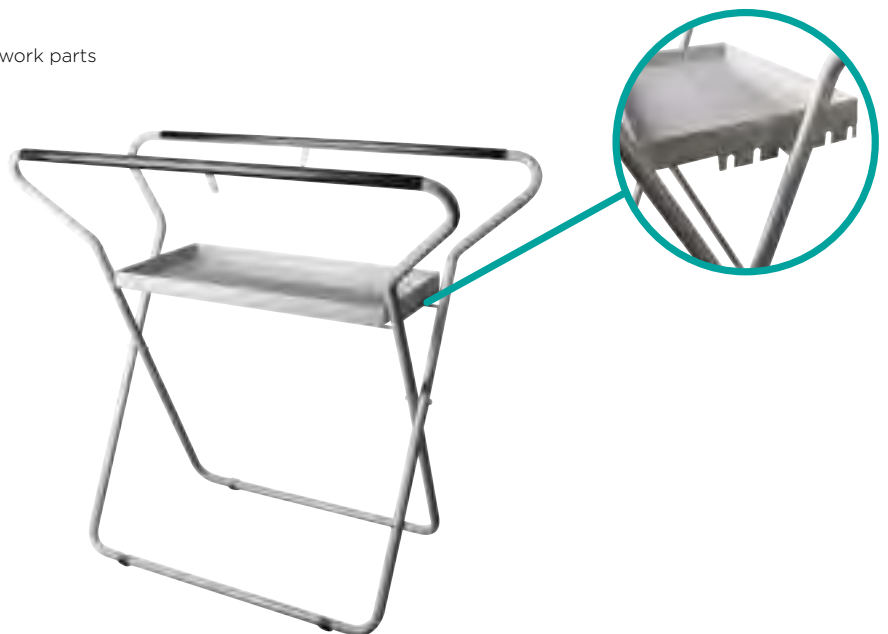

#### Specifications:

- Anti-scratch plastic support stands
- Stand width: 930mm
- 6 positions for spacing the stands:
  - 300mm (Height: 1090mm)
  - 405mm (Height: 1060mm)
  - 515mm (Height: 1015mm)
  - 625mm (Height: 950mm)
  - 730mm (Height: 880mm)
  - 845mm (Height: 775mm)
- Tray dimensions: L.690xW.340xD.36mm
- Dimensions of the folded trestle: L.1110xW.75xD.1125mm





TN

## UNIVERSAL TELESCOPIC BODYWORK STAND 23-138cm

OC 0716

**+** Does not scratch paintwork



**Specifications:**

- width: 22.5 à 138cm
- height: 84 à 132cm
- anti-slip rubber-sheathed support arm
- support arm length: 86cm
- support arm width: 8cm
- capacity: 100kg
- 4 swiveling wheels, 2 of which have brakes

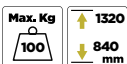

## PARTS/WINDSCREEN/COVERS DOLLY

TN

OC 6041



**Specifications:**

- independent, sliding, foam covered support bars
- height of support bars: 570mm
- 6 modifiable compartments to hold the parts in total safety
- length: 1200mm
- width: 700mm
- height: 775mm
- 2 of the wheels have brakes
- Ø wheels: 90mm





TN

### MULTI-PURPOSE BODY SUPPORT

OC 0726

Multi-purpose bodywork support, adjustable to fit a wide range of parts such as bumpers, doors, hoods, fenders...

**NEW**

**+** Foldable for easy storage

- Specifications:**
- length: 15mm
  - width: 600mm
  - height: 1250mm

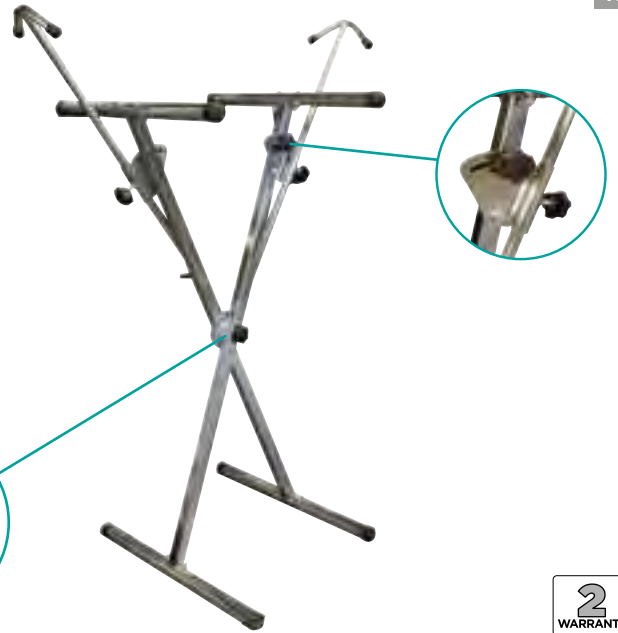

### BUMPER WALL BRACKET

OC 0727

Support for 4 bumpers of different sizes. Locking system for fixed position or wall storage. Keeps bumpers safe after painting. Maximum capacity per shelf 20kg.



**+** Space-saving

- Specifications:**
- length: 1000mm
  - width: 500mm
  - height: 1500mm



**NEW**



TN



### MULTI-POSITION SUPPORT SHOCK ABSORBER

OC 0729

Multi-position bumper support. Fully adjustable in width, depth and height

**+** Adjustable

- Specifications:**
- length: 1940-2040mm
  - width: 300-600mm
  - height: 1300mm



**NEW**

TN





TN

ROTATING PAINT RACK 2 RIMS

OC 0728

360° rotating easel for painting wheel rims.  
Adjustable in width and height from 1100 to 1420mm.  
For rims from 15" to 22".

NEW

+ Rotating and adjustable



Specifications:

- length: 1360mm
- width: 600mm
- height: 980-1260mm



BODYWORK 3 TRAY STORAGE TROLLEY

OC 0711

Allows parts which have been uninstalled to be put away and stored such as headlights, headrests, instrument panels, bumpers...



Specifications:

- 3 trays (2 wooden and 1 mesh)
- platform height: 260-810-1390mm
- mesh base
- 4 swiveling wheels, 2 of which have brakes
- dimensions: L.630xW.1110xH.1625mm



BODYWORK SUPPORT

OC 0717

Completely adjustable to accommodate a wide range of parts such as doors, bonnets, wings...

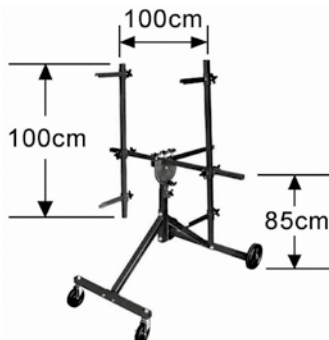

Specifications:

- length: 960mm
- width: 780mm
- height: 165mm





# BODYWORK VEHICLE HANDLING

TN

## PAIR OF MECHANICAL DOLLIES 1180kg

OM 2034

Ideal for effortlessly moving vehicles that have broken down or are parked in tight spaces.

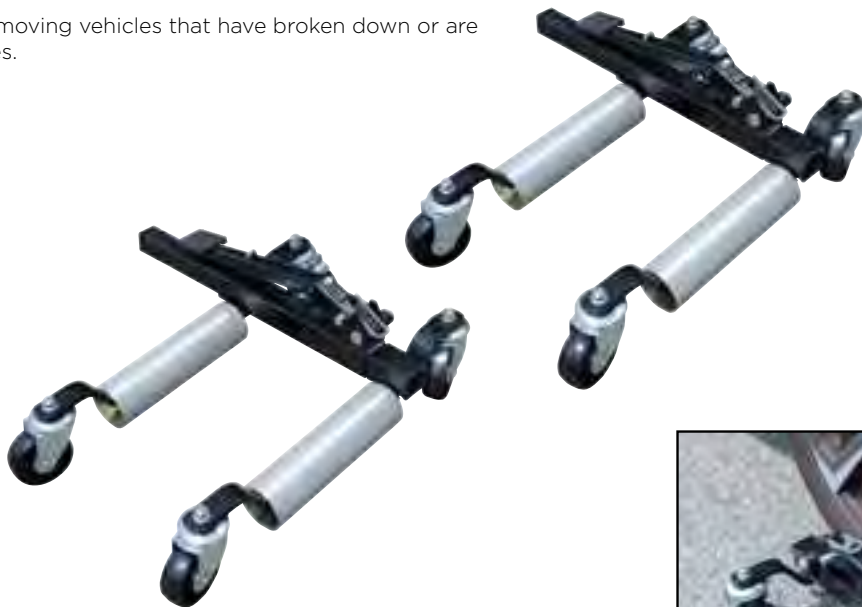

**Specifications:**

- lifting assisted by mechanical rack
- steel rollers L.280mm
- 4 wheels, 2 with brakes
- capacity: 1180kg
- working area: 340-710mm
- minimum and maximum wheel diameter: 450-810mm
- max capacity width: 11" (280mm)
- weight: 15.9kg



TN

## TROLLEY BLOCKED UNDER CAR BODY 450kg

OC 1200

Articulated buffers  
4 swiveling wheels Ø148mm  
(SA7061)

Height 350mm

Width 600mm

from 1150 to 1800mm



SA 7061 PIVOTING DOLLY WHEEL Ø148mm

Spare part of OC 1200/OC 1101/OC 1102





# BODYWORK LIFTING

TN

## HYDROPNEUMATIC MOBILE LIFTING COLUMN 1500kg

OH 9150

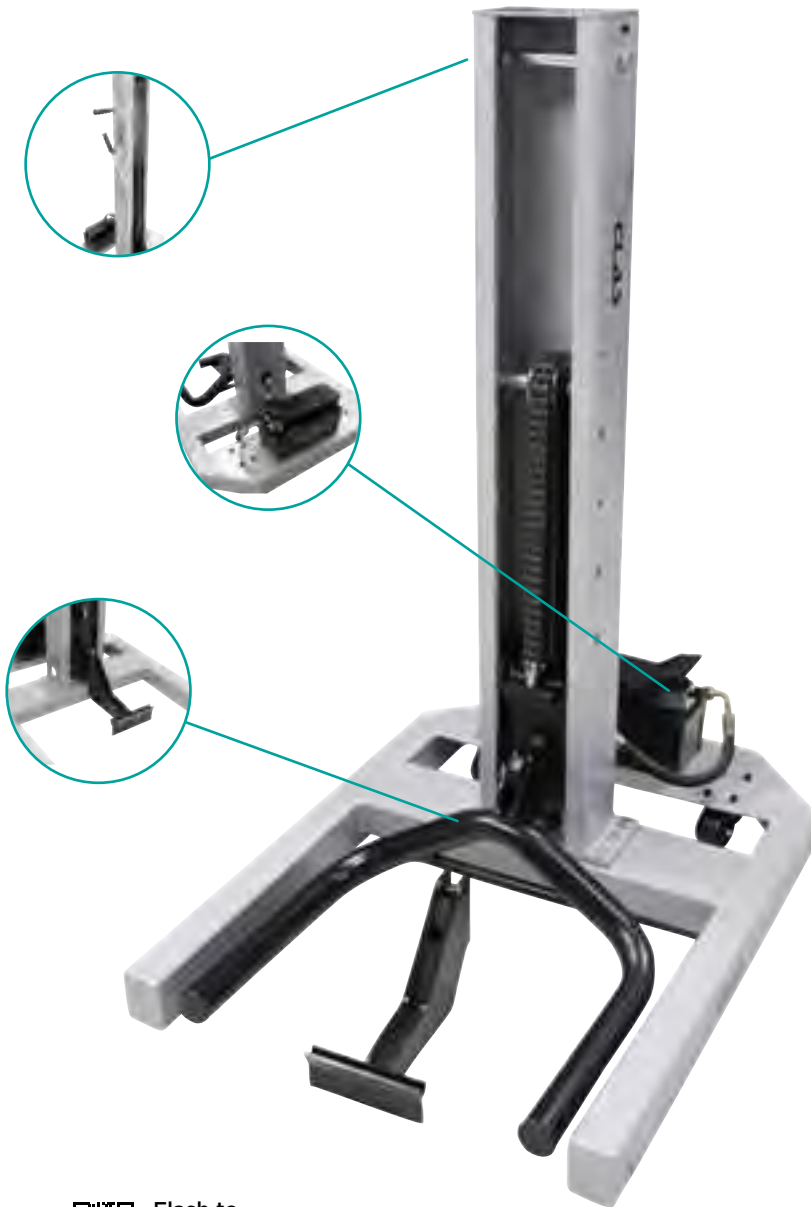

Flash to watch the video!

**+** Allows the vehicle to be lifted in less than a minute.

Supplied with:

- SA9151: lifting under the wheel  
Max. working height: 735mm  
Min. height: 100mm  
Wheel diameter from 480 to 730mm
- SA9152: lifting under the car body  
Max. working height: 835mm  
Min. height: 140mm

**Specifications:**

- 2 swivel wheels to facilitate handling
- safety pin: 5 secure heights
- lifting by the wheel or the car body
- mobile and fast

Max. T 1.5	↑ 735 ↓ 100 mm	kg 135
---------------	----------------------	-----------

# 1.5T

2 WARRANTY





**BODY REPAIR LIFT TABLE DUAL CYLINDER 400V 3T ON/IN-GROUND**

PE 8101T

Lifting table, in or on-ground, selected by micro-switch in the console.  
 Underbody preparation table for bodybuilders, enables the vehicle to be lifted to the desired height for an ergonomic working position, protects against RSI.  
 Ideal for minor dent removal, underbody work, sanding, painting, etc.  
 In or on ground, electro-hydraulic operation.  
 Pneumatic arm opening and closing.  
 Reversible pad storage on console.

**+** Pneumatic arm opening and closing

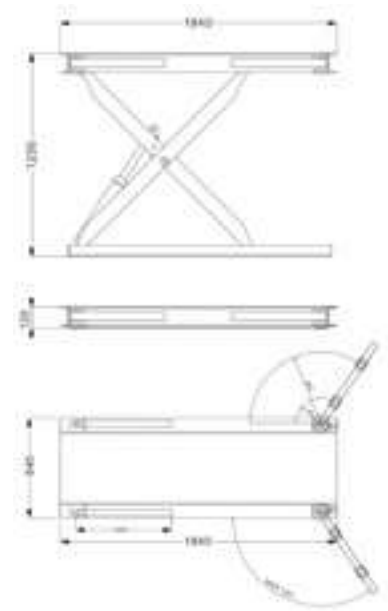
**Specifications:**

- lifting height: 110-1230mm
- lifting time: +/- 50 s
- lowering time: +/- 30 s
- platform height: 120mm
- closed dimension: L. 1840xl. 640mm
- max. open dimension l 1837mm
- control console
- drive power 2.2kW 400V bar -) 400V/50Hz
- air supply 6-8bar
- double-cylinder version, with mechanical position-holding safety device (rack)
- 124° opening of 4 arms with reversible buffers
- Epoxy paint
- emergency lowering system in case of power failure
- intermediate stop at 30 cm from the ground if on-ground or 19 cm if in-ground for operator safety and anti-crushing audible signal
- concrete strength/quality: 200mm-C20/25





# ROLLER CABINET

## BODY REPAIR ROLLER CABINET 190 TOOLS

EG 8888

TN



OS 4100



OS 3000



OS 5000



OS 3200



OS 0850



OS 2000



OC 6081



OC 6080



OS 1200



OS 1210



- EG0087 : 1 x 7 drawers roller cabinet
- OC0811 : 1 x hammer + block set (7 pcs)
- OM0749BL : 1 x riveting pliers
- SA0115 : 1 x plastic chisel
- OC0033 : 1 x trim clip plier
- OM8081 : 1 x lock grip plier 190mm
- OM8080 : 1 x lock grip pliers 225mm
- OP1510 : 1 x 1/4»-3/8» d. mini ratchet wrench kit
- OP1203 : 1 x mini die grinder ø6mm 25,000rpm
- OM0643 : 1 x 5 carbide rotary rasps box
- EG0680 : 1 x drill set hss cobalt 5% (25pcs)
- EG8009 : 1 x dispenser/hand towel roll stand for drawers
- EG8001 : 1 x metal workshop waste for drawer
- OS3200 : 1 x ratchet insert 1/4» (59 pcs)
- OS4100 : 1 x combination wrench insert 6-24mm (17 pcs)
- OS3000 : 1 x 1/2» ratchet insert (23 pcs)
- OS5000 : 1 x plier insert (4 pcs)
- OS2000 : 1 x hex t-handle wrench insert 3-10mm (7 pcs)
- OC1700BL : 1 x windscreen wiper remover
- OC0302 : 1 x scraper and utility knife set
- OC8078 : 1 x 5 pcs nylon trim removal set
- SA0881 : 1 x hammering insert
- OM0801 : 1 x 6 pin driver set with base
- OM0803 : 1 x automatic punch
- OM0160 : 1 x rivoir hammer composite handle 1000gr
- OM0170 : 1 x dead blow hammer with interchangeable tip 32mm
- OM0800 : 1 x extra flat splitting chisel
- OP1451 : 1 x ø13mm reversible drill
- OC6081 : 1 x wide bodywork spoon
- OC6080 : 1 x long bodywork spoon
- OP0099 : 1 x straight blowgun pen
- OS1200 : 1 x diamond screwdriver insert ph-slotted (8pcs)
- OS1210 : 1 x 7 pcs t10-40 diamond torx screwdriver insert





# WELDING PLIERS

## 16 PACK LOCK GRIP PLIERS

TN

OM 8069



**Contents:**

- OM8082 (x3): lock grip pliers 285mm
- OM8080 (x5): lock grip pliers 225mm
- OM8083 (x3): lock grip pliers 240mm
- OM8081 (x5): lock grip pliers 190mm



### LOCK GRIP PLIER 190mm

TN

OM 8081

Spare part of OM 8069



### LOCK GRIP PLIER 285mm

TN

OM 8082

Spare part of OM 8069



### LOCK GRIP PLIER 240mm

TN

OM 8083

Spare part of OM 8069



### LOCK GRIP PLIERS 225mm

TN

OM 8080

Spare part of OM 8069



### BODYWORK PLIERS

TN

OC 0025

Model equipped with a swiveling head to punch (Ø5mm) and fold (12mm) sheet steels before welding.  
For sheet steel 1.4mm maxi.



### OVERLOAD CIRCUIT BREAKER 12-24V

TN

OE 1224

- Max. clamping voltage 12V:
- 32.5V/308A (8-20µs)
  - 25.2V/59.5A (10-1000µs)
- Max. clamping voltage 24V:
- 59.0V/169A (8-20µs)
  - 45.7V/33A (10-1000µs)





# BODYWORK CYLINDER

## 4T COLLISION REPAIR SET

TN

OC 0803

**Specifications:**

- minimum pusher cylinder travel: 325mm
- maximum pusher cylinder travel: 425mm

**Contents:**

- SA0805: 4T hydraulic ram
- SA0806: 4T 1/4" hydraulic hand pump
- SA0804: spreader 500kg
- SA0802: hose 1/4"
- bit/support set
- SA1805: bodywork hydraulic ram 4T extension set



4T



SA 0806	4T 1/4" HYDRAULIC HAND PUMP	Spare part of OC 0803/OC 0801
SA 0807	10T HYDRAULIC RAM	Spare part of OC 0804/OC 0802
SA 0808	10T 1/4" HAND PUMP	Spare part of OC 0804/OC 0802
SA 0803	1/4 HYDRAULIC MALE ADAPTER	Spare part of OC 0803/OC 0804/OC 0801/OC 0802
SA 0804	SPREADER PLIERS	Spare part of OC 0803/OC 0804/OC 0801/OC 0802
SA 0805	4T HYDRAULIC RAM	Spare part of OC 0803/OC 0801

★ TOP PRODUCT

TN

## 10T COLLISION REPAIR SET

OC 0804

A must-have tool for automotive and industrial repair work on straightening, handling and lifting.

For SA 1815 :

Delivered with a set of 5 sleeved extensions :

- usable length: 546mm (with 590mm nozzle, Ø 30mm sleeve) (x1)
- usable length: 300mm (with 342mm nozzle, Ø 30mm sleeve) (x2)
- usable length: 197mm (with 234mm nozzle, Ø 30mm sleeve) (x1)
- usable length: 97mm (with nozzle 140mm, Ø 30mm sleeve) (x1)

**Contents:**

- SA0807: 10T hydraulic ram
- SA0808: 10T 1/4" hydraulic hand pump
- SA0804: spreader 500kg
- SA0802: hose 1/4"
- bit/support set
- SA1815: bodywork hydraulic ram 10T extension set



10T





TN

### BODYWORK CYLINDER SET PUSHER/PULLER 1/4"

OC 0705



SA 0703	MINI 4T RAM
SA 0704	2T RAM
SA 0705	MINI 10T RAM
SA 0706	4T RAM
SA 0707	10T RAM
SA 0708	5T PULLING JACK



### AIR HYDRAULIC PUMP 10T 1/4"

OH 0014

Accessory of OH 9150



Delivered without hose (SA0802)

**Specifications:**

- 700bar
- aluminum frame
- internal load limiting device
- exhaust muffler
- dimensions: L.255xW.135xH.185mm

# 10T



### AIR HYDRAULIC PUMP 10T 1/4" & 3/8"

OH 0024

Accessory of DM 0204/OH 3453/OM 9385/OM 9387/OC 0705/OC 0803/OC 0804

Pump to be coupled with a multitude of hydropneumatic tools such as bodybuilder cylinders, hydraulic extractors etc...

**+** Versatility



# 10T





# BODYWORK HAMMERS

## HAMMER + BLOCK SET (7 PCS)

OC 0811



Hickory handle



OC 0812	PLANISHING HAMMER WITH ROUND FLAT HEAD AND POINTED TIP
OC 0813	PLANISHING HAMMER WITH HORIZONTAL TIP
OC 0814	FINISHING HAMMER ROUND/CROSS-HATCHED SQUARE
OC 0815	BLOCK COMMA 130x55mm
OC 0816	BLOCK RAIL/UNIVERSAL 60X60X56mm
OC 0817	BLOCK CLAW 78x60x27mm
OC 0818	BLOCK ANVIL 80x62x55mm

**Contents:**

- 3 hammers with GENUINE HICKORY handles L.310mm:
  - OC0812: planishing hammer with round flat head and pointed tip
  - OC0813: planishing hammer with round flat head straight tip
  - OC0814: cornering hammer with round and square gridded head
- 4 blocks:
  - OC0815: comma 130x27mm
  - OC0816: rail/universal 60x60x56mm
  - OC0817: claw 78x60x27mm
  - OC0818: anvil 80x62x55mm



## WIDE BODYWORK SPOON

OC 6081

Dent removal spoon ideal for bodywork.



**Specifications:**

- forged steel
- length: 260mm
- width: 50mm



## LONG BODYWORK SPOON

OC 6080

Dent removal spoon ideal for bodywork.



**Specifications:**

- forged steel
- length: 335mm
- width: 45mm



## BODYWORK SLIDE HAMMER SET

OC 2211

Thanks to its numerous pulling accessories, in addition to the weight, it can be used to straighten small body parts.

**Contents:**

- hammer 4.5kg
- stroke 50cm
- handle with guard
- SA4221: pigs tail end
- SA4213: long curved hook 6cm
- SA4214: short curved hook 4cm
- SA4223: 90° hook U
- SA4216: 90° hook flat
- SA4218: straight end
- SA4219: screwed end
- SA4220: chain end



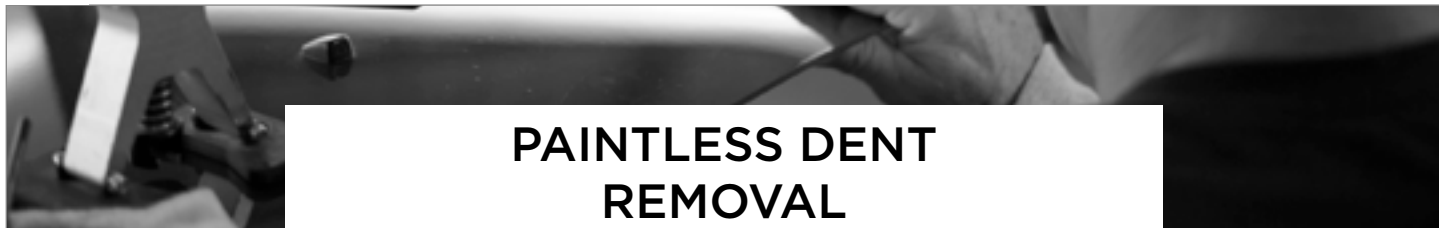

# PAINTLESS DENT REMOVAL

TN

## AUTO DENT REPAIR KIT WITH SLIDE HAMMER

OC 0113

This kit is designed to repair car bodies which have been damaged by hail, or small dents with no need to repaint the part.

The process consists of sticking plastic pulling tips with the gun and the glue especially made for bodywork, and to connect the inertial weight or the pulling lever and then have the painted sheet without damaging it. Then you can remove the pulling end with any cleaning solvent (not supplied) and the nylon chisel.

### Contents:

- SA0112: inertial stainless steel hammer+pulling end
- SA0113: pulling lever (DSP) to remove dents
- SA4205: glue gun 240V-200°C-30W
- SA3110: 8 glue sticks
- SA0114: 12 pulling tips of various diameters
- SA0115: nylon chisel to remove the pulling tips
- SA0116: bottle of solvent to remove the pulling tips
- 1 strong PVC box



## 10 BLACK GLUE STICK SET

TN

OC 0403



Ø11mm  
Rigid



## 10 AMBER GLUE STICK SET

TN

OC 0405



Ø11mm  
Flexible



## 10 WHITE GLUE STICK SET

TN

OC 0406



Ø11mm  
Intermediate



## STICKS OF STRONG GLUE 10 PIECES

TN

SA 3110

Spare part of OC 0113



## 12 PCS PULLING END SET

TN

SA 0114

Spare part of OC 0112/OC 0113

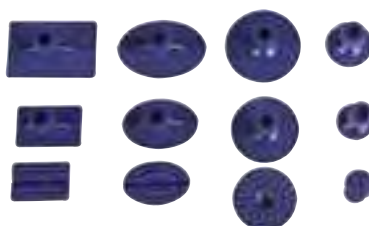

## AIR CAULKING GUN

TN

SA 4205

Spare part of OC 0112/OC 0113





### 14 PCS BODYWORK ROD SET

OC 8100

TN



Assortment of 12 auto body work rods not requiring paint. Ideal for pushing out hailstone marks, small dents on a door and other marks. Supplied in a carry-case.

- Rod lengths:
- 1 x 280mm
  - 4 x 300mm
  - 1 x 350mm
  - 1 x 450mm
  - 2 x 700mm
  - 2 x 750mm
  - 1 x 900mm



SA 8001 4 END SET



### SUCTION CUP SUPPORT RODS Ø120mm CAPACITY 20kg

OC 8110

Accessory of OC 8100

TN

Suction cup for use with paintless bodywork rods (OC8100). The rods can be passed through 1 of the 5 holes in the strap to act as a pull lever.



### BODYWORK LAMP

OE 1226

Emits parallel beams, highlights bodywork deformations.

TN

**Specifications:**

- 5m power cable
- on/off switch
- protective glass with 3 black stripes
- opal film
- 24V DC flexible LED strip
- light output approx. 800Lm
- suction cup Ø120mm and flexible arm 300mm long black with cross handle

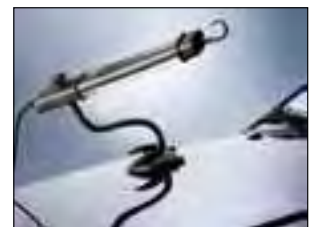

12 watt LED light supplied with tiltable suction cup holder with shape memory.







TN

## MANUAL VACUUM DENT PULLER

OC 0210

Slide hammer for paintless dent removal



Manual pump requiring no external air supply

**Contents:**

- SA0227: suction cup Ø75
- SA0228: suction cup Ø100
- SA0229: suction cup Ø125mm
- SA0224: draw hook
- SA0410: manual pump for venturi

Slide hammer weight: 1.22kg



## DOUBLE SUCTION CUP

OC 0608

Suction strength 60kg  
Ø160mm large suction cup  
Ø90mm small suction cup





# PLASTIC REPAIRING

TN

## REAR PARKING SENSOR PUNCH TOOL KIT Ø17-Ø22mm

OM 0700

This hollow punch kit allows holes of the required diameter to be punched in the front and rear bumpers in order to install bumper sensors (reversing sensors).

**+** Does not damage paintwork  
No deburring

### Specifications:

- tempered steel hollow punch
- max. punch diameter: 4 to 6mm depending on the diameter of the hollow punch
- compatible with pawls and ratchet hammers
- 13mm hex drive



Requires a Ø8.5mm pre-punch

### COMPOSITION

OM 0717	EMPORTE-PIECES POUR CAPTEURS DE STATIONNEMENT Ø17mm
OM 0718	REAR PARKING SENSOR PUNCH TOOL Ø18mm
OM 0719	REAR PARKING SENSOR PUNCH TOOL Ø19mm
OM 0720	REAR PARKING SENSOR PUNCH TOOL Ø20mm
OM 0722	REAR PARKING SENSOR PUNCH TOOL Ø22mm
OM 0721	REAR PARKING SENSOR PUNCH TOOL Ø21mm

### OPTIONAL KITS OM 0700

OM 0730	REAR PARKING SENSOR PUNCH TOOL Ø30mm
---------	--------------------------------------

2  
WARRANTY





# PLASTIC REPAIRING

← FIND THE ALL PLASTIC REPAIRING RANGE HERE

## PLASTIC REPAIR KIT

TN

OC 6049

Ideal for small plastic repairs on bumpers, headlight fixings, mirrors, interior trim, etc.

### Contents:

- SA6042: 1 soldering iron with special soldering tip
- SA6081: 6 brazing rods (PP-Polypropylene)
- SA6082: 6 brazing rods (PS-Polystyrene)
- SA6083: 6 brazing rods (PE-Polyethylene)
- SA6084: 6 brazing rods (ABS)
- SA6080: 5 pieces of 304 stainless steel grids
- soldering iron holder



## BI-COMPOSING GUN 50ml

TN

OC 1025

Allows the application of two-component adhesives in 50ml cartridges. Delivered with piston 2:1



## BLACK STRUCTURAL GLUE 50ml

TN

CO 1024

Accessory of OC 1024/OC 1025

**+** Ideal for plastic repair

### Specifications:

- time required for structuring: 1min
- time required for drying: 5min
- 2K polyurethane glue



## AEROSOL COOLANT FOR PLASTIC REPAIRS

TN

SA 6039

Spare part of OC 6039

With its freezing power of 45°C, the gas rapidly cools the various adhesives used in bodywork, and can also shrink metal parts (bearings).



## TWO-PART EPOXY GLUE 25ml

TN

CO 1067

All-materials bonding.

5 min epoxy glue is the glue for all those who want a fast (5-minute setting), ultra-resistant bond. This epoxy glue can be used on all substrates and materials: wood, metal, ceramics, glass, plastic, stone, earthenware, concrete, marble...

**+** Takes less than 5 minutes





# CORDLESS THERMAL STAPLER + 300 STAPLES KIT

OC 6070

Ideal for autonomous plastic repair.

Easy to use thanks to its 4-position articulated head (fast approach to work in corners or confined spaces).

Equipped with a thermal protection (30 seconds working cycle).

Also equipped with a Led on the head for a better visibility.

Stainless steel staples

**+** Speed of intervention

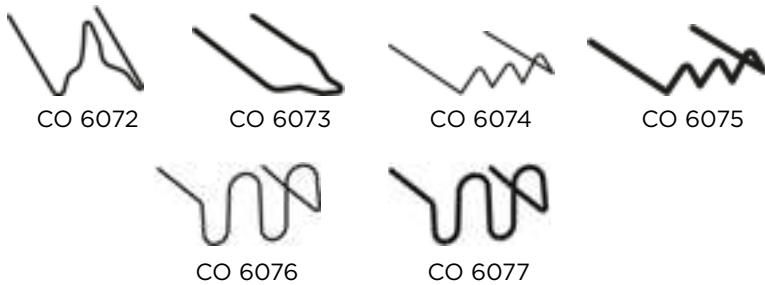

Protection against overheating



Max. temperature **600°C**

**3.7V**  
4000mAh **Li-ion** battery

**Specifications:**

- length (without electrode): 220mm
- total length: 255 mm
- width: 35mm
- heating temperature: 600°C
- input current: DC 5V 2A
- output current: 3.7 8A Max
- battery: 3.7V 4000mAh Li-ion
- charging time : 3H
- capacity 400 staples with battery in one charge (hot stapler)



CO 6072	BOX OF 50 STAPLES M Ø 0.6 MM
CO 6073	BOX OF 50 STAPLES V Ø 0.8 MM
CO 6074	BOX OF 50 STAPLES S Ø 0.6 MM
CO 6075	BOX OF 50 STAPLES S Ø 0.8 MM
CO 6076	BOX OF 50 STAPLES U Ø 0.6 MM
CO 6077	BOX OF 50 STAPLES U Ø 0.8 MM

**Adjustable head, 4 positions**





# BODYWORK PAINTING PREPARATION

TN

## CENTRAL VACUUM CLEANER 2x1300W

EG 0055

Accessory of OE 1319/OE 1318

Vacuum cleaner that can also be used as a central vacuum cleaner. Compatible with pneumatic and electric tools up to 1200W.



Automatic filter cleaning at each use



### Specifications:

- 76L plastic tank mounted on 4 castors trolley
- 2 motors 1300W
- tool tray 600x480mm
- hose Ø28mm 4.5m with integrated pneumatic hose
- depression 23.5kPa
- air flow rate: 119l/s
- noise level: 68dB
- dimensions: 580x590x940mm

### Accessories included:

- SA0405: hose Ø28mm 4.5m
- SA0406: filter



### Options:

- SA0409: 5 bags 77L
- SA5505: flexible Y-adapter for 2 operators
- SA5506: Y-pneumatic adapter for 2 operators



TN

## 2.5mm RANDOM ORBITAL PALM SANDER Ø150mm

OP 1312

## 5mm RANDOM ORBITAL PALM SANDER Ø150mm

OP 1311



CO 1312	3 FLEXIBLE INTERFACES Ø150/5mm
CO 1313	3 FLEXIBLE INTERFACES Ø150/10mm
CO 1311	MEDIUM MULTI-HOLE VELCRO® TRAY Ø150mm/8mm





500ml PHOSPHATE TREATMENT

TN

CO 1078

Specially designed for fast-acting rust treatment.

This treatment and phosphating spray can be used as a preventive or curative rust treatment. It neutralizes oxidation already present or protects surfaces from future oxidation. Our triple-action phosphating treatment stops rust, degreases the surface and ensures high adhesion for immediate painting after treatment. Our treatment guarantees a stable, ready-to-paint surface for optimum paint durability.



**+** Best before painting

High bonding  
Insulates the surface  
Fast action



STRIPPING LIQUID 1L

TN

CO 1086

Perfect for rust stripping, special high-efficiency soaking.

This solution rapidly dissolves all iron oxide. The liquid solution allows surfaces to be impregnated by soaking. This exclusive formula quickly dissolves rust without any mechanical intervention. Non-flammable product. Will not affect rubber materials such as seals. The product can be diluted in any proportion or used neat, depending on the oxidation level of the surface to be treated or the speed of dissolution required. Ideal for removing all traces of oxidation from metal or aluminum surfaces, it guarantees optimum results.



**+** Special soaking

Dissolves rust  
Special soaking  
Highly effective



500ml STRIPPING GEL

TN

CO 1087

Perfect for rust stripping with precise, drip-free application.

This gel solution rapidly dissolves all iron oxide. The gel solution allows surfaces to be impregnated by spraying. This exclusive formula quickly dissolves rust. Its gel formula ensures good adhesion to all substrates. Non-flammable product. Will not affect rubber materials such as gaskets. Ideal for removing all traces of oxidation from metal or aluminum surfaces, it guarantees optimum results.



**+** Precise application

Dissolves rust  
High bonding  
Highly effective



400ml RUST REMOVER SOLVENT

TN

CO 1088

Great for dissolving rust and freeing parts.

The rust remover treatment unlocks rusted parts. Its super-powerful active effect creates a reaction on contact with iron oxide, turning the solution from white to intense violet. This exclusive formula completely dissolves rusted connections, making them easy to unblock. It allows rapid absorption of the degreaser sprayed on beforehand. Its foamy formula ensures optimum adhesion to all surfaces, enhancing its efficiency.



**+** 2 in 1

Chemical reaction  
Dissolves rust  
Makes degreasing easier



**CONSUMABLES****PAINT**

CO 1002	PLASTIC PRIMARY SPRAY 400ml	Color: transparent
CO 1004	VARNISH SPRAY 1K 400ml	Respect for colorimetry
CO 1027	EXPRESS PAINT REMOVER SPRAY 500ml	Active formula: quick and efficient
CO 1001	DARK GREY GARNISHING PRIMER 500ml	Fast drying time Quick sanding
CO 1042	LIGHT GREY FILLER PRIMER 500ml	
CO 1044	BLACK FILLER PRIMER 500ml	

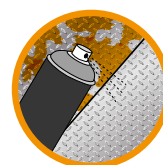
**BODYWORK**

CO 1003	BUMPER STRUCTURING SPRAY MEDIUM GRIT 400ml	Scratch-resistant
CO 1029	BODY REPAIR DEGREASING/CLEANING SPRAY 500ml	Degreases and removes silicone Antistatic
CO 1033	ANTI STONE-CHIP SPRAY 400ml	Exclusive thick formula, remains supple after drying
CO 1035	NO RUST SPRAY 400ml	Transparent
CO 1086	STRIPPING LIQUID 1L	Special soaking
CO 1087	500ml STRIPPING GEL	Precise application
CO 1088	400ml RUST REMOVER SOLVENT	2 in 1
CO 1078	500ml PHOSPHATE TREATMENT	Best before painting
CO 0505	5 PLASTIC RENOVATION WIPES	Easy to use
CO 0504	5 CHROME RENOVATION WIPES	
CO 0506	BODYWORK DEGREASER 1L	Cleans and degreases all types of dirt.
CO 0507	BODYWORK DEGREASER 5L	

**GLUE**

CO 1047	GREY GLUE AND MASTIC CARTRIDGE 310ml	Adhesion without primer on metallic surfaces
CO 1048	BLACK GLUE AND MASTIC CARTRIDGE 310ml	
CO 1022	WHITE GLUE AND MASTIC CARTRIDGE 310ml	
CO 1023	MULTI-FUNCTIONAL GLUE SPRAY 400ml	With no filament, it remains flexible after drying
CO 1024	BLACK STRUCTURAL GLUE 50ml	Ideal for plastic repair
CO 1034	ANTI GRAVEL MS POLYMER BLACK CARTRIDGE 310ml	Ideal for spray-on joints
CO 1057	ANTI GRAVEL MS POLYMER BEIGE CARTRIDGE 310ml	
CO 1058	ANTI GRAVEL MS POLYMER GREY CARTRIDGE 310ml	





# BODYWORK PAINTING GUN

## SANDBLASTING GUN

OP 1481

For projection of soundproofing products, sealants and anti-rust.



**Specifications:**

- nozzle Ø: 6mm
- working pressure: 8bar max.
- air consumption: 100 to 150l/min



TN

## MAGNETIC PAINTWORK SUPPORT WITH PLIERS

OC 0028

Designed for painting small components such as rear-view mirror shells, metal sections, plastic casings...



TN

## HVLP PROFESSIONAL SPRAY PAINT GUN

OP 1335

HVLP gravity gun for bodywork and finishing work.

**Specifications:**

- excellent spread and spray
- reworked ergonomics to make it more comfortable to handle
- stainless steel nozzle, brushed aluminum body Ø2mm
- polyamide tub 600ml
- filter
- service pressure: 1 to 2bar



SA 1312	Ø1.2mm NOZZLE
SA 1314	Ø1.4mm NOZZLE
SA 1316	Ø1.6mm NOZZLE
SA 1320	Ø2mm NOZZLE



Connector and Ø2mm nozzle supplied



TN

## MINI PROFESSIONAL SPRAY GUN HVLP

OP 1336

HVLP gravity gun for retouching and finishing.

**Specifications:**

- excellent spread and spray
- ergonomic, easy to hold
- Ø0.8mm nozzle
- filter
- service pressure: 1 to 2bar



Connector and Ø0,8mm nozzle supplied

TN







# BODYWORK PAINTING DRYING

## ★ TOP PRODUCT

TN

### STRAIGHT BLOWGUN PEN

OP 0099

**+** Always close to hand



- pocket blowgun
- adjustable flow
- duralumin body
- length 110mm
- opening/closure by rotation



## DRYING GUN

TN

OP 3501



### Specifications:

- compressed air venturi system
- airflow regulator
- max. flow 6bar
- consumption 350l/min
- noise level in dB: 72dB at 3.5bar
- service pressure 2 to 4bar
- dust filters



## 4 DRYING GUNS + 2 BASES

TN

OP 3520

### Specifications:

- ideal for drying tops and bottoms of vehicles
- fully adjustable base max. 2.08m
- power supply via spiral hose
- fast connectors
- 2 guns can be up to 0.85m apart



## 2 DRYING GUNS + BASE

TN

OP 3510

### Specifications:

- ideal for drying tops and bottoms of vehicles
- fully adjustable base max. 2.08m
- power supply via spiral hose
- fast connectors
- 2 guns can be up to 0.85m apart





## DOORS & CABIN

### AIR WEDGE

OC 1103

For keeping pneumatically-operated doors open to make it easier to install windscreens.

Cushion dimensions:  
155x165mm

**+** Rigid PVC panel:  
makes insertion easier



TN

2  
WARRANTY

### DOOR OPENING SET (9 PCS)

OC 9000BL

Kit comprising tools and rods allowing a vehicle door to be opened without breaking the windows if its keys have been locked inside.



**B.LINE**  
BUDGET SOLUTION

Strictly for professional use only.  
Supplied without instructions.

2  
WARRANTY

TN

### AIRBAG LINE TEST

AC 7023



2  
WARRANTY

TN

### U-SHAPED SEMI-RIGID ROD TO HOOK DOOR HANDLES 1.50m

EG 0744



1.5 m



2  
WARRANTY

TN

### SLIP KNOT SEMI-RIGID ROD TO HOOK DOOR HANDLES 1.10m

EG 0745



1.1 m

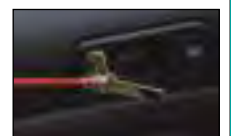

2  
WARRANTY

TN



# BODYWORK STAPLES

← RETROUVEZ LA GAMME COMPLETE D' **BODYWORK STAPLES** RANGE HERE



## BODYWORK STAPLES

### GARNISHING TRIM SET (27PCS)

TN

OC 8881

The tools are made of composite material to preserve damage to the components. The different models allow to work in many different settings.

Delivered in a thick canvas storage case with a slot for each tool.

Lever set to remove door panels, window moldings, dashboards and trim, both inside and outside. They can also be used to remove glue remains.



### 5 PCS NYLON TRIM REMOVAL SET

TN

OC 8078



### TOOL FOR REMOVING DOOR STAPLES

TN

OC 8081



### TRIM CLIP PLIER

TN

OC 0033



OEM codes :  
3392

