

clas.com

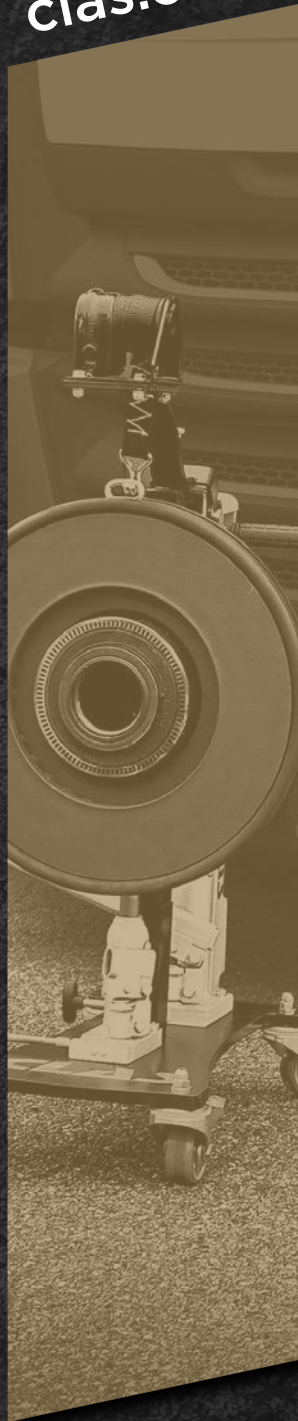

CLAS[®]

GLOBAL GARAGE SOLUTIONS





3

WORKSHOP EQUIPMENT



4 - LIFTS



23 - WHEEL SERVICE EQUIPMENT



39 - AIR COMPRESSORS



45 - AIR PIPE FITTINGS



51 - WORKSHOP FURNITURE



54 - EXHAUST GAS EXTRACTION



64 - STORAGE SPILL CONTAINMENT



67

GENERAL TOOLS



68 - LIGHTING



78 - FLUID DISTRIBUTION & GREASING



83 - CLEANING



89 - REELS



94 - PNEUMATIC TOOLS



111 - WORKSHOP DEVICE



124 - DRILLING & THREADING



128 - LIFTING



151 - PRESS SHOP



153

HAND TOOLS



154 - TOOL CABINETS



156 - TOOL CASES



168 - TIGHTENING KEYS



170 - SOCKET & RATCHET



182 - SCREWING



187 - PLIERS



189 - HAMMERING TOOLS



192 - TORQUE WRENCHES



195 - MEASUREMENT & CONTROL



196 - CUTTER & SCRAPER



197

MECHANICS



198 - TIRE & WHEEL



203 - BRAKING



216 - OIL DRAINING



221 - COOLING SYSTEM



226 - ELECTRONIC DIAGNOSTIC



231 - CHARGING SYSTEM



236 - AIR CONDITIONING



251 - STEERING & SUSPENSION









261 - SILENT BLOC

-  **266** - HUB
-  **292** - TIMING TOOLS
-  **319** - PISTON & CYLINDER
-  **281** - BEARING
-  **302** - SPARK PLUG & GLOW PLUG
-  **321** - FUEL
-  **283** - CLUTCH
-  **304** - INJECTORS
-  **324** - ADBLUE®
-  **285** - GEARBOX
-  **315** - CYLINDER HEAD













325 HYBRID & ELECTRIC

-  **332** - PROTECTION
-  **341** - INSULATED TOOLS
-  **335** - SIGNS
-  **347** - LIFTING
-  **338** - ELECTRONICS
-  **350** - REELS & LOAD



353 BODY REPAIR

-  **356** - LIGHTING
-  **376** - PULLING & RESTRAINING
-  **359** - AUTO GLASS
-  **382** - PLASTIC REPAIRING
-  **369** - BODYWORK HANDLING
-  **385** - BODYWORK PAINTING
-  **371** - BODYWORK LIFTING
-  **391** - DOORS & CABIN
-  **374** - ROLLER CABINET
-  **392** - BODYWORK STAPLES
-  **375** - WELDING & CUTTING

CLOTHING
p. 405



394 CONSUMABLES



Find the products you're looking for easily, thanks to the pictograms at the side of each page and the thematic index at the end of the catalog. scan the QR codes at the top of each page to go directly to the product families. don't forget, our entire product range is on **clas.com**

Find us also on the networks



Discover us on the videos!



WORKSHOP EQUIPMENT



LIFTS

P. 4



WHEEL SERVICE EQUIPMENT

P. 23



AIR COMPRESSORS

P. 39



AIR PIPE FITTINGS

P. 45



WORKSHOP FURNITURE

P. 51



EXHAUST GAS EXTRACTION

P. 54



STORAGE SPILL CONTAINMENT P. 64

CHOOSE YOUR LIFT PROPERLY.

Key points to consider

- type of vehicle to be lifted?
- required lifting capacity?
- type of service: bodywork, painting, geometry, mechanics?

There is also the question of the space and height available in the workshop and the quality of the floor.

A flat and thick slab is required for the installation of some post lifts (fixing in the concrete).

A study must be carried out beforehand to know if the installation is possible... or not.



THE DIFFERENT TYPES OF LIFTS

SINGLE POST LIFT OR 1 POST LIFT



- +** Low space requirement
Mobile
Perfect for operations on the sides of the vehicle
No heavy construction needed
- Does not allow for all underbody repairs, neither geometry
To be considered as an additional lift

2 POST LIFTS



- +** High load capacity
Low space requirement
Lightweight
- Stability
Setting up the vehicle

4 POST LIFTS



- +** Perfect for LCV's
Can be used for storage (vehicle below + above)
- Space requirement

SCISSOR LIFTS



- +** Easy to set up
Lifting speed
Intervention possible on 4 sides of the vehicle
- Offset control panel



OUR POST LIFT RANGE

REF	TYPE	CAPACITY	ROCKER PANEL	TIRES	GEOMETRY	BODY REPAIR	PAINTING
PE 1000	1 column	3T					
PE 2000M/T - PE 2001M/T	2 columns	4T	•	•			
PE 2004M/T - PE 2005M/T	2 columns	4T	•	•			
PE 2008T - PE 2003T - PE 2009T	2 columns	4T	•	•			
PE 2002T - PE 2006T - PE 2007T	2 columns	5T	•	•			
PE 2010T - PE 2011T - PE 2012T	2 columns	6T	•	•			
PE 4000T	4 columns	5.5T				•	•
PE 4001T	4 columns	5.5T			•	•	•
PE 4002T	4 columns	5T		•	•	•	•
PE 6000M/T - PE 6002M/T	scissor	3T		•		•	•
PE 6001M/T - PE 6005M/T	double scissor	3T		•		•	•
PE 6004M/T	double scissor	3.5T		•		•	•
PE 6006M/T	simple scissor	5T		•	•	•	•
PE 6007	simple scissor	5.5T		•	•	•	•
PE 8000M/T - PE 8001M/T	lifting table	3T		•		•	•

Post lift references in bold can be mounted on screeds of less than 20 cm.



THINK ABOUT IT !

- 84574 SA 3028
- 84575 SA 3012
- 84576 SA 3011
- 84577 SA 3027





SINGLE POST LIFTS

TE

1 COLUMN MOBILE POST LIFT 3T

PE 1000

Optimized work thanks to fast lifting and lowering times (+/- 45 seconds).
Simple operation: lifting and lowering via control box.
Maximum safety: electromagnetic unlocking of the safety catches, without mechanical lever, emergency lowering system in case of power failure.
Particularly suitable for painting and bodywork activities, brake and tyre service.

Electro-hydraulic post lift.
Flexibility of use: easily manoeuvrable thanks to its travel kit, without floor fixation.
Working comfort: equipped with an access ramp with a 100mm high lowered ground clearance for simplified vehicle pick-up.
Small footprint: compact, ideal for small spaces.
High variability: multiple lifting capacities thanks to the 4 telescopic arms in 2 parts and adjustable threaded pads (100 - 170mm).

+ Load capacity 3T
Small footprint



- Specifications:**
- lifting height: 100-1810mm
 - ascent/descent time: +/- 45s
 - drive voltage: 2.2Kw/230V/50Hz
 - foundations: thickness without flooring: 200mm
 - delivered pre-assembled, saving time during assembly





2 POST LIFTS

2 COLUMNS ASYMETRIC POST LIFT 400V 4T

PE 2001T

2 COLUMNS ASYMETRIC POST LIFT 230V 4T

PE 2001M

Electro-hydraulic post lift.

Hydraulic unit: fast ascent and descent (+/- 40 seconds).

Multiple lifting capacities thanks to the telescopic arms in asymmetrical version (short front 3 stages from 560mm to 995mm - long rear 2 stages from 660 to 1210mm).

NOTE

Pads and wedges
p. 21

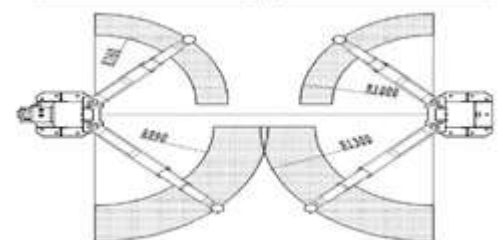
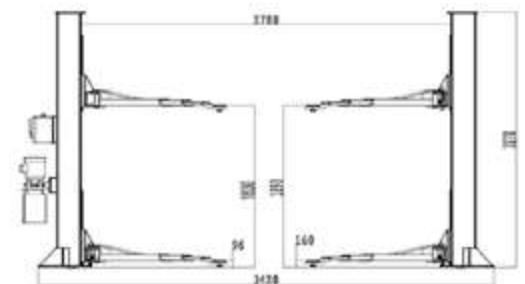
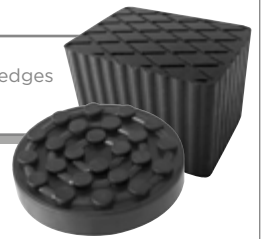

Specifications:

- lifting height : 105-1890mm
- lifting time : +/- 40s
- lowering time : +/- 40s
- driving power: 2.2kW
- drive voltage: (3 -) 400/50 V/Hz
- concrete strength/quality: 200mm-C20/25
- adjustable buffers on screw 55mm stroke.
- electromagnetic release of the safety catches
- overload and pipe breakage safety
- system synchronization: by cable.
- protection strip for cylinder, chain and cables included on each column
- made in Europe
- epoxy paint



Options :

- PE0007: Mercedes/Iveco 105-135mm extension sets





2 COLUMNS ASYMETRIC POST LIFT WITH BASEMENT 400V 4T

PE 2000T

2 COLUMNS ASYMETRIC POST LIFT WITH BASEMENT 230V 4T

PE 2000M

Specially designed for screeds that do not meet the minimum thickness requirements of 200mm, or have a slight flatness problem.

Electro-hydraulic post lift.
Push cylinder on cart, without chain.
Multiple lifting capacities thanks to the telescopic arms in asymmetrical version (short front 3 stages from 560mm to 995mm - long rear 2 stages from 660 to 1210mm).
Cylinder and cable protection strip included on each column.

+ Low thickness slab

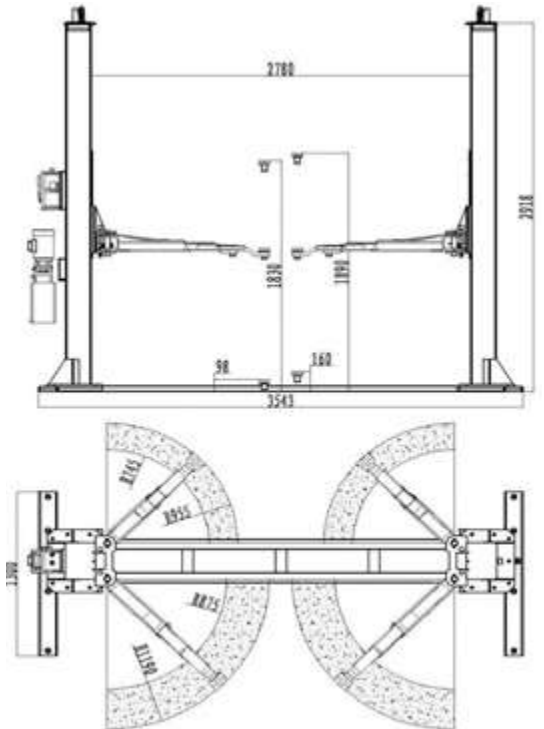

Specifications:

- lifting height: 126-1890mm
- lifting time: +/- 40s
- lowering time: +/- 40s
- drive power: 2.2 kW
- electrical voltage of the drive: (3 -) 400/50 V/Hz
- adjustable pads on 55mm stroke screw
- electromagnetic unlocking of the safety notches
- overload safety and hose rupture
- bevelled columns for large door openings
- synchronization system by cable
- made in Europe
- Epoxy painting

NOTE Consult us for installation and commissioning.
Do not install on a slab less than 150mm thick.
For warranty purposes, installation and commissioning must be carried out by a professional.
Shipping costs excluded.





2 HEIGHTS POSSIBLE

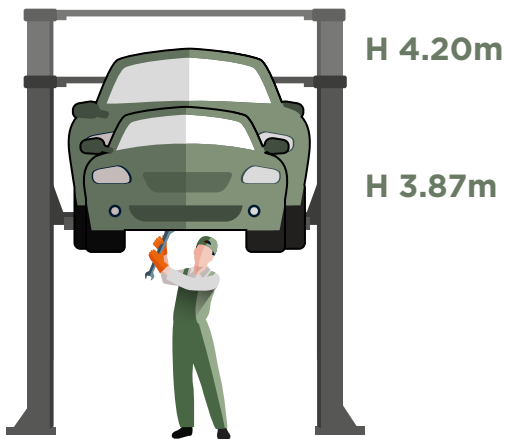

Electro-hydraulic post lift.
Push cylinder on cart, without chain.
Hoses and cables pass through the top for optimum working comfort, allowing free access under the vehicle for equipment (cylinders, oil recovery system, etc.), making it easier to clean the workshop.

Multiple lifting capacities thanks to the telescopic arms in asymmetrical version (front 3 stages from 560 to 995mm, rear long 2 stages from 660 to 1210mm) allowing precise lifting of low or utility vehicles.

Adjustable pads on 55mm stroke screw equipped with 70mm extension.

Electromagnetic unlocking of the safety notches, overload safety and hose rupture.

System synchronisation: by cable.

Cylinder, chain and cable protection strip included on each column.

Particularly suitable for repair activities.

European origin, powder coated.

2 COLUMNS POST LIFT 400V 4T HIGH
PASSAGE 3876mm 2.2Kw

PE 2004T

2 COLUMNS POST LIFT 230V 4T HIGH
PASSAGE 3876mm 2.2Kw

PE 2004M

2 COLUMNS POST LIFT 400V 4T HIGH
PASSAGE 4200mm 2.2Kw

PE 2005T

2 COLUMNS POST LIFT 230V 4T HIGH
PASSAGE 4200mm 2.2Kw

PE 2005M



Specifications:

- lifting height : 105-1890mm
- lifting time : +/- 40s
- lowering time : +/- 40s
- driving power: 2.2kW
- drive voltage: (3 -) 400/50 V/Hz
- concrete strength/quality: 200mm-C20/25
- adjustable buffers on screw 55mm stroke (+ 70mm extension)
- electromagnetic unlocking of safety catches
- overload and pipe rupture safety
- system synchronization: by cable.
- protection strip for cylinder, chain and cables included on each column
- made in Europe
- epoxy paint

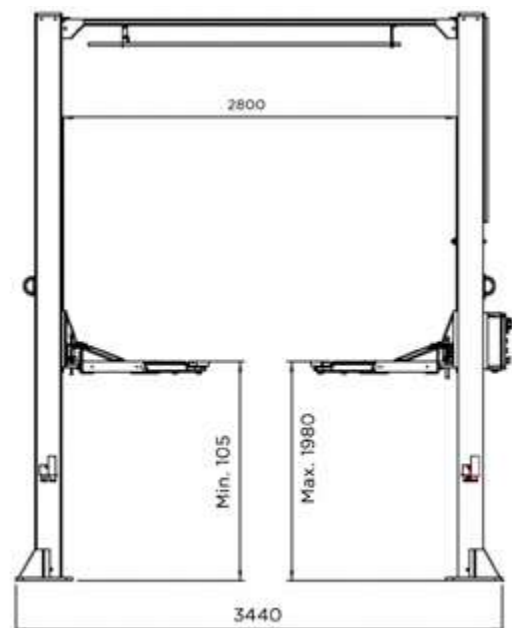

4T



3 HEIGHTS POSSIBLE

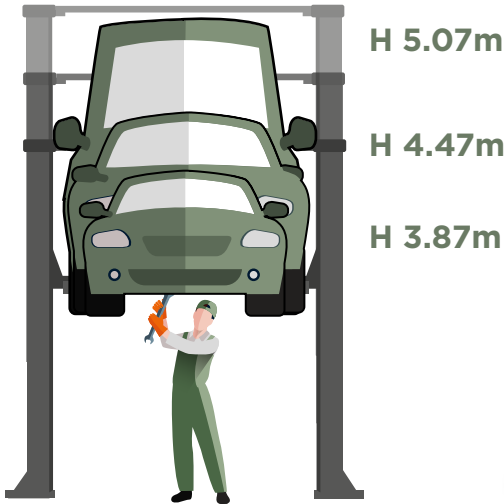

2 COLUMNS POST LIFT 400V 4T HIGH
PASSAGE 3870mm 2.6kw

PE 2008T

2 COLUMNS POST LIFT 400V 4T HIGH
PASSAGE 4470mm 2.6kw

PE 2003T

2 COLUMNS POST LIFT 400V 4T HIGH
PASSAGE 5070mm 2.6kw

PE 2009T

+ Height adjustable to the millimeter

Electro-hydraulic post lift.

Hoses and cables pass through the top for optimum working comfort, allowing free access under the vehicle for equipment (cylinders, oil recovery system, etc.), making it easier to clean the workshop.

Multiple lifting capacities thanks to the telescopic arms in asymmetrical version (front short 3 stages from 640 to 1200mm, rear long 2 stages from 775 to 1550mm) allowing a precise lifting of low or utility vehicles.

Specifications:

- lifting height: 65-1980mm
- lifting time: +/- 40s
- lowering time: +/- 40s
- drive power: 2.6 kw
- electrical voltage of the drive: (3-) 400/50 V/Hz
- strength/quality of concrete: 200mm-C20/25
- adjustable pads on 55mm stroke screw (+ 70mm and 160mm extension)
- electromagnetic unlocking of the safety notches
- overload safety and hose rupture
- bevelled columns for large door openings
- hydraulic synchronization system
- made in Europe
- Epoxy painting

Options:

- PE0007: Mercedes / Iveco extension sets 105-135mm





TE

3 HEIGHTS POSSIBLE

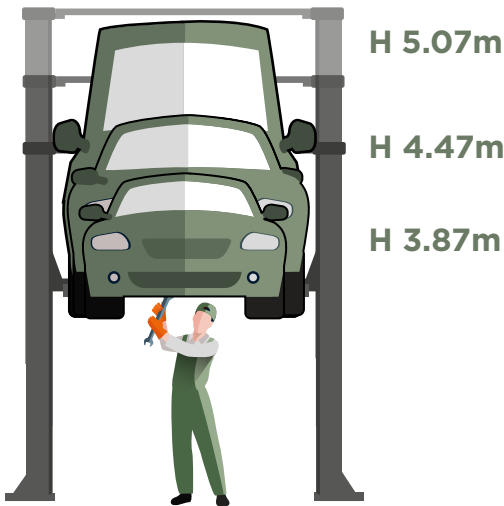

2 COLUMNS SYMETRIC POST LIFT 400V 5T
HIGH PASSAGE 3870mm 2.6Kw

PE 2002T

2 COLUMNS SYMETRIC POST LIFT 400V 5T
HIGH PASSAGE 4470mm 2.6Kw

PE 2006T

2 COLUMNS SYMETRIC POST LIFT 400V 5T
HIGH PASSAGE 5070mm 2.6Kw

PE 2007T



Height adjustable
to the millimeter

Especially adapted to repair activities on commercial vehicles and 4x4.

Electro-hydraulic post lift.

Hoses and cables pass through the top for optimum working comfort, allowing free access under the vehicle for equipment (cylinders, oil recovery system, etc.), making it easier to clean the workshop. Hydraulic unit with fast up and down (+/- 50s). Adjustment possibility, equipped with a position securing device for precise intervention, gearbox assembly, nut alignment...

Multiple lifting capacities thanks to the telescopic arms in symmetrical 3-stage version from 860 to 1700mm for precise vehicle lifting. Adjustable pads on 55mm stroke screw equipped with 70mm and 160mm extension.

Electromagnetic unlocking of the safety catches, overload safety and hose rupture.

Hydraulic synchronization system.

Made in Europe, powder coated.

Specifications:

- lifting height : 95-2050mm
- lifting time : +/- 50s
- lowering time : +/- 50s
- driving power: 2.6kW
- drive voltage: (3 -) 400/50 V/Hz
- concrete strength/quality: 200mm-C20/25
- adjustable buffers on screw stroke 55mm (+ raised 70 and 160mm)
- electro-magnetic unlocking of the safety notches
- bevelled columns for large door openings
- overload and hose rupture safety
- semi-automatic hydraulic system synchronization
- made in Europe
- epoxy paint

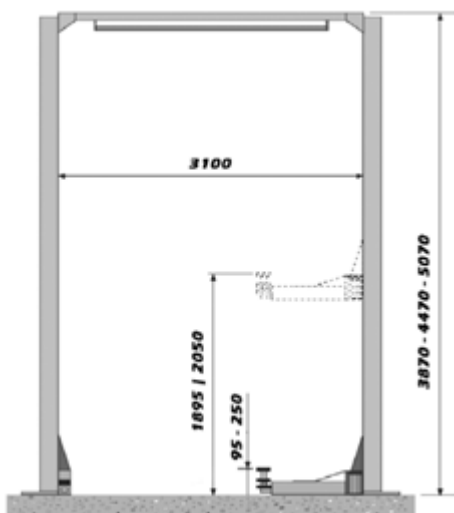



3 HEIGHTS POSSIBLE

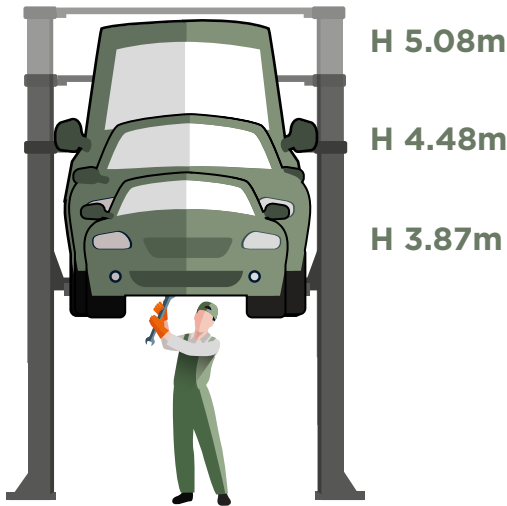

2 COLUMNS POST LIFT 400V 6T HIGH
PASSAGE 3870mm 2.6Kw

PE 2010T

2 COLUMNS POST LIFT 400V 6T HIGH
PASSAGE 4480mm 2.6Kw

PE 2011T

2 COLUMNS POST LIFT 400V 6T HIGH
PASSAGE 5080mm 2.6Kw

PE 2012T

+ Large scope of application

Electro-hydraulic post lift.

Hoses and cables pass through the top for optimal working comfort, allowing free access under the vehicle for equipment (jacks, oil recuperator...), making it easier to clean the workshop.

Hydraulic unit: quick up and down with adjustment possibility, equipped with a position securing device for precise intervention, gearbox assembly, nut alignment...

Multiple lifting capacities thanks to the articulated arms in symmetrical version (3 stages from 790 to 1890mm) allowing lifting adjustable to the millimeter of vehicles.

Specifications:

- lifting height : 100-1920mm
- lifting time : +/- 80s
- lowering time : +/- 100s
- driving power: 2.6kW
- drive voltage: (3 -) 400/50 V/Hz
- concrete strength/quality: 200mm-C20/25
- adjustable buffers on screw 55mm stroke (+ raised 70 and 160mm)
- electro-magnetic unlocking of the safety notches
- bevelled columns for large door openings
- overload and hose rupture safety
- semi-automatic hydraulic system synchronization
- made in Europe
- epoxy paint

Options :

- PE0007: Mercedes/Iveco 105-135mm extension sets

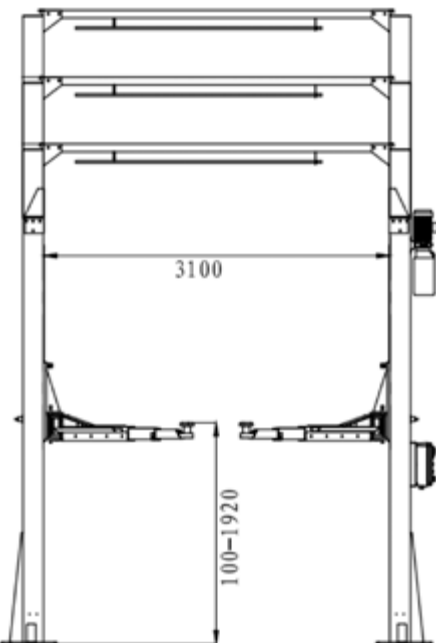

+ Multi-joint arms





4 POST LIFTS

4 COLUMNS POST LIFT FLAT TRACK 400V 5.5T

PE 4000T

Electro-hydraulic post lift.
Working comfort: one-piece access ramps, quick and easy vehicle positioning with low ground clearance, allows for quick repair or inspection, 5.19m long paths
Equipped with guides for optional lifting crossbeam.

NOTE

Pads and wedges
p. 21

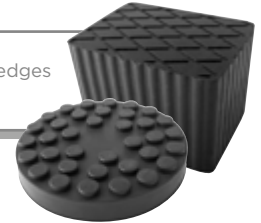

+ Camping cars and vans



Specifications:

- lifting height : 196-1846mm
- lifting time : +/- 45s
- lowering time : +/- 45s
- width/length of runways: 490 /5190mm
- distance between the adjustable tracks: 800-1100mm
- air supply 8bar
- drive power: 2.2kW
- Drive voltage: (3 -) 400/50V/Hz
- concrete strength/quality: 200mm-C20/25
- maximum safety: single-cylinder lift, 4-cable drive, pneumatic release of safety catches, safety system in case of cable breakage, emergency lowering system in case of power failure, intermediate stop and sound signal
- made in Europe
- Epoxy paint

Options :

- PE0008: 1600mm boom extension
- PE7000: 3T hydropneumatic lifting crossbar



THINK ABOUT IT !

HYDROPNEUMATIC ROLLING JACK 3T

PE 7000

Accessory of PE 6006/PE 6007/PE 4000/PE 4001/PE 4002/PE 4000T/PE 4001T/PE 6006M/PE 6006T/PE 4002T/PE 6007T



3T **2** WARRANTY

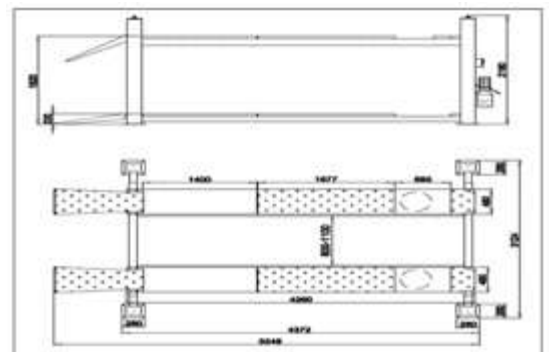

5.5T **2** WARRANTY



4 COLUMNS POST LIFT FLAT OSCILLATION TRACK 400V 5.5T

PE 4001T

Electro-hydraulic post lift.

Working comfort: One-piece access ramps, quick and easy positioning of the vehicle, see ramp option for low ground clearance vehicles, allows quick repair or inspection, 5.19 m long tracks.

Equipped with guides for optional lifting crossbeam.



+ Special geometry

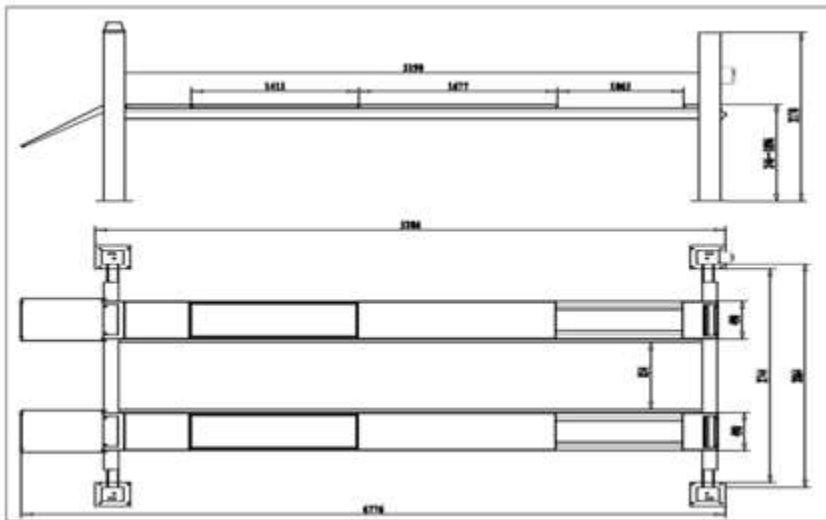

THINK ABOUT IT !

TE

HYDROPNEUMATIC ROLLING JACK 3T

PE 7000

Accessory of PE 6006/PE 6007/PE 4000/PE 4001/PE 4002/PE 4000T/PE 4001T/PE 6006M/PE 6006T/PE 4002T/PE 6007T



Hydropneumatic pump included.



Specifications:

- lifting height: 246-1896mm
- lifting time: +/- 45s
- lowering time: +/- 45s
- width/length of tracks: 490-5190mm
- distance between the adjustable tracks: 800-1100mm
- air supply 8bar
- drive power: 2.2kW
- drive voltage: (3 -) 400/50 V/Hz
- concrete strength/quality: 200mm-C20/25
- maximum safety: single-cylinder lift, 4-cable drive, pneumatic release of safety catches, safety system in case of cable breakage, emergency lowering system in case of power failure, intermediate stop and sound signal
- made in Europe
- Epoxy paint

3T

5.5T



4 COLUMNS POST LIFT 5T AUXILIARY LIFT 3.5T

PE 4002T

Electro-hydraulic post lift.

Working comfort: access ramps equipped with an auxiliary lift with a capacity of 3.5T with pneumatic safety.

fast and easy positioning of the vehicle with low ground clearance, allows a quick repair or inspection, 5.19m long and 640mm wide paths.

Suitable for mechanical intervention, VL, VUL, camping car, construction equipment.
European origin, powder coated.



Special geometry

**Specifications:**

- lifting height: 250-1890mm
- lifting time: +/- 45s
- lowering time: +/- 55s
- track width/length: 640 /5190mm
- air supply 8bar
- drive power: 2.2kW
- drive voltage: (3 -) 400/50 V/Hz
- concrete strength/quality: 200mm-C20/25
- Made in Europe
- Epoxy paint



6T



SCISSOR LIFTS

TE

**FIXED
OR
MOBILE
VERSION**

MOBILE SCISSOR LIFT DUAL
CYLINDER LOW RAISE 400V 3T

PE 6000T

SCISSOR LIFT DUAL CYLINDER
LOW RAISE 400V 3T

PE 6002T

MOBILE SCISSOR LIFT DUAL
CYLINDER LOW RAISE 230V 3T

PE 6000M

SCISSOR LIFT DUAL CYLINDER
LOW RAISE 230V 3T

PE 6002M

Especially adapted to painting, bodywork and brake and tyre service activities.

Ease of access: 105mm high lowered floor passage, lockable access ramps for extended lifting platforms.

Up and down control by push buttons on control box.

Working comfort: easy movement thanks to its set of 3 removable wheels and its traction handle.

+ Outdoor intervention possible

105-960mm



1850mm (530-790-530)



Specifications:

- lifting height : 105-960mm
- lifting time: +/- 20s
- lowering time: +/- 20s
- track width/length: 530/1450-2036mm
- system synchronization: photo cell
- drive power: 2.2kW
- drive voltage: (3 -) 400/50 V/Hz
- Scissor control: double hydraulic master-slave system
- full power lifting at the lowest point 105mm.
- maximum safety: double hydraulic safety system (without mechanical detent or compressed air)
- emergency lowering system in case of power failure
- anti-crushing intermediate stop to CE standards and sound signal
- European origin

THINK ABOUT IT !

TE

SUV KIT FOR SCISSOR LIFTS

PE 0006

Accessory of PE 6000/PE 6002/PE 6000M/
PE 6000T/PE 6002M/PE 6002T

Specifications:

- set of 2 support crossbars for 4x4 underbody grip + extensions
- equipped with 2 telescopic pads lengthwise
- dimensions:
L.1360xI.100xH.225mm

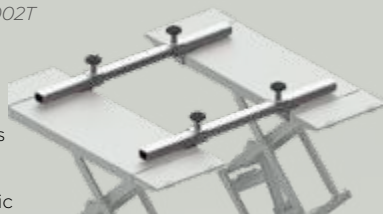

3T





MUST-HAVE

3T

DOUBLE SCISSOR LIFT
DUAL CYLINDER 400V 3T

PE 6001T

DOUBLE SCISSOR LIFT
DUAL CYLINDER 230V 3T

PE 6001M

3.5T

DOUBLE SCISSOR LIFT
DUAL CYLINDER 400V 3.5T

PE 6004T

DOUBLE SCISSOR LIFT
DUAL CYLINDER 230V 3.5T

PE 6004M

3T + mechanical safety

DOUBLE SCISSOR LIFT DUAL
CYLINDER WITH MECHANIC LOCK
400V 3T

PE 6005T

DOUBLE SCISSOR LIFT DUAL
CYLINDER WITH MECHANIC LOCK
230V 3T

PE 6005M

Delivered with 4 pads h.60mm



Especially adapted to painting, bodywork and brake and tyre service activities.
Installation possibilities: floor-standing or floor built-in.

Ease of access: 100mm high lowered floor passage, lockable access ramps for extended lifting platforms
Up and down control by push buttons on control console
Powerful lift: Extended mechanical tilt lever system, for full power lift at the lowest point 100mm
Working comfort: scissors control by double hydraulic master-slave system; synchronization control by photocell.

Specifications:

- lifting height : 100-1950mm
- lifting time : +/- 40s
- lowering time : +/- 35s
- width/length of tracks: 650/1420-2000mm
- system synchronization: photo cell
- width/length of floor required for installation: 2000/2030mm
- drive power: 2.2kW
- drive voltage: (3 -) 400/50 V/Hz
- concrete strength/quality: 200mm-C20/25
- Maximum safety: double hydraulic safety system (without mechanical lock and compressed air), emergency lowering system in case of power failure, anti-crushing intermediate stop according to CE standards and sound signal
- made in Europe

2
WARRANTY

THINK ABOUT IT !

SUV KIT FOR
SCISSOR LIFTS

PE 0001

Accessory of PE 6001/PE 6005/
PE 6004/PE 6001M/PE 6001T/
PE 6004M/PE 6004T/PE 6005M/
PE 6005T

Specifications:

- set of 2 support crossbars for 4x4 underbody socket.
- equipped with 2 telescopic pads lengthwise
- dimensions: L.1360xW.100xH.225mm

2
WARRANTY



EXTRA LOW PROFILE SCISSOR LIFT AUXILIARY LIFT 400V 5.5T

PE 6006T

EXTRA LOW PROFILE SCISSOR LIFT 5.5T AUXILIARY LIFT 230V 5.5T

PE 6006M

Especially adapted for technical inspection, geometries, repair and adjustment of headlights.
Installation possibilities: floor-standing or floor built-in for LV and LCV.

Working comfort: quick and easy mounting of the vehicle on the 220mm extra-low deck.
Maximum safety: 2 thrust cylinders, 1 cylinder with mechanical secure position hold (rack and pinion) for position stabilization.
European origin, powder coated.



Extra low-profile 220mm



Specifications:

- lifting height : 220-1860mm
- lifting time : +/- 50s
- lowering time : +/- 60s
- track width/length : 620/5030mm
- system synchronization: photo cell
- drive power: 2.2 kw
- drive voltage: (3 -) 400/50 V/Hz
- Made in Europe
- Epoxy paint

Contents:

- rear slip plates
- slots for swivel trays
- auxiliary lift 5.5T, lift height 450mm with ramp extension L: 1450mm to 2000mm
- guide rails for a lifting crossbeam

Options:

- PE7000: 3T pneumatic lifting crossbar
- EG8380: pair of turntables
- PE0004: front slip plates

Max. T 5.5	KG 2550	230V	2200 W
---------------	------------	------	--------

THINK ABOUT IT !

TE

UV KIT FOR HIGH SCISSOR LIFTS

PE 0012

Accessory of PE 6006/PE 6007/PE 6006M/PE 6006T

Specifications:

- 2 support bars set for 4x4 under chassis + extensions



5.5T





TE

SCISSOR LIFT 5T AUXILIARY LIFT 3.5T PACK. 1/1

PE 6007T

Especially adapted for technical inspection, geometries, repair and adjustment of headlights.

Installation possibilities: floor-standing or floor built-in for LV and LCV.

Maximum safety: 1 push cylinder with mechanical secure position hold (rack) for position stabilization. Safety is pneumatic. Made in Europe, powder coated.

NOTE

Please contact us for installation and start-up. Within the framework of the warranty, installation and start-up must be carried out by a professional. Transportation costs not included.



NOTE

Pads and wedges p. 21

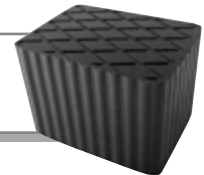

Specifications:

- lifting height: 350-2155mm
- lifting time: +/- 65s
- lowering time: +/- 60s
- width/length raceways: 625/5400mm
- system sync: photo cell
- drive power: 2.6kw
- electrical voltage of the drive: (3 -) 400/50 V/Hz

Contents:

- Slip plates
- Slots for swivel trays
- Auxiliary lift 3500 kg, lift height 425mm with ramp extension L: 1430mm to 2050mm
- Guide rails for a lifting crossbeam

Options:

- EG8380: pair of turntables
- PE0003: 6-movement front sliding plate for technical control
- PE7000: 3T pneumatic lifting crossbar
- PE0008: access ramp extension 1600mm



THINK ABOUT IT !

TE

UV KIT FOR HIGH SCISSOR LIFTS

PE 0012

Accessory of PE 6006/PE 6007/PE 6006M/PE 6006T

Specifications:

- 2 support bars set for 4x4 under chassis + extensions





BODY REPAIR LIFT TABLE MONO CYLINDER WITH MECHANIC LOCK 400V 3T

PE 8000T

BODY REPAIR LIFT TABLE MONO CYLINDER WITH MECHANIC LOCK 230V 3T

PE 8000M

NOTE

Please consult us for installation and commissioning. Under warranty, installation and commissioning must be carried out by a professional. Transport costs not included.

Underbody preparation table for body builders, allows the vehicle to be lifted to the desired height for an ergonomic working position, protects against MSDs. Ideal for small dent removal, work on rocker panels, sanding, painting... To be embedded, electro-hydraulic operation.



+ High elevation

Specifications:

- lifting time: +/- 50 s
- lowering time: +/- 60 s
- working height: 260-1730mm
- closed dimension: L. 2348 X W. 700mm
- max. open dimension L. 2836 X W. 1610mm
- drive power 2.2 kW 220bar
- electrical voltage of the drive: (3 -) 400V/50 Hz
- air supply 6/8bar
- single-cylinder version, with mechanical hold-in position safety device (rack and pinion).
- opening of the 4 arms equipped with 120° buffers
- European origin
- powder coated hinges
- weight: 780kg



3T



BODY REPAIR LIFT TABLE DUAL CYLINDER 400V 3T

PE 8001T

BODY REPAIR LIFT TABLE DUAL CYLINDER 230V 3T

PE 8001M



Underbody preparation table for body builders, allows the vehicle to be lifted to the desired height for an ergonomic working position, protects against MSDs. Ideal for small dent removal, work on rocker panels, sanding, painting... To be embedded, electro-hydraulic operation,



Specifications:

- lifting time: +/- 50 s
- lowering time: +/- 60 s
- working height: 125-1300mm
- closed dimension: L. 1960 X W. 880mm
- max. open dimension: L. 2303 X W. 1668mm
- drive power 2.2 kW 220bar
- electrical voltage of the drive: (3 -) 400V/50Hz
- air supply 6/8bar
- double-cylinder version, with mechanical hold-in position safety device (rack and pinion).
- opening of the 4 arms equipped with 120° buffers
- European origin
- powder coated hinges
- weight: 880kg



3T





PADS & BLOCKS

Rubber SBR 80° SHORE A
Only sold per 4

Detailed schematics and
dimensions on clas.com

	Libelles	REF	Ø interior	Ø exterior	Compatibility	
	ROUND RUBBER PAD Ø160x28mm	EG 1135	153 mm	160 mm	Suitable for Koni, Romerico, Car-o-Liner	
	ROUND RUBBER PAD Ø120x26mm	EG 1139	111 mm	120 mm	Suitable for Ravaglioli	
	ROUND RUBBER PAD Ø98x21mm	EG 1140	85 mm	98 mm	Suitable for Ravaglioli, Sirio, Space	
	ROUND RUBBER PAD Ø124x26mm	EG 1141	108 mm	124 mm	Suitable for ATH, Ravaglioli, Werther	
	ROUND RUBBER PAD Ø143x25mm	EG 1142	116 mm	143 mm	Suitable for OMCN	
	ROUND RUBBER PAD Ø147x26mm	EG 1144	136 mm	147 mm	Suitable for Ravaglioli	
	ROUND RUBBER PAD Ø140x27mm	EG 1145	133 mm	140 mm	Suitable for OMCN	
	REINFORCED ROUND RUBBER PAD (2 METALLIC WASHERS) Ø120x32mm	EG 1146	108 mm	120 mm	Suitable for Launch, Twin Busch, RP Tools	
	REINFORCED ROUND RUBBER PAD (METALLIC PLATE) Ø125x24mm	EG 1147	120 mm	125 mm	Compatible with Nussbaum, AMI	
	ROUND RUBBER PAD Ø130x10mm	EG 1148	125 mm	130 mm	Suitable for Ravaglioli, Siro, Space	
	ROUND RUBBER PAD Ø150x10mm	EG 1149	130 mm	150 mm	Suitable for Ravaglioli	
	REINFORCED ROUND RUBBER PAD (1 METALLIC WASHER) Ø120x4mm	EG 1150	110 mm	120 mm	Suitable for ATH, Hofmann, Hermann, JAB Becker	
	REINFORCED ROUND RUBBER PAD (METALLIC PLATE) Ø120x22mm	EG 1151	113 mm	120 mm	Compatible with MAHA	
	REINFORCED ROUND RUBBER PAD (METALLIC PLATE) Ø125x26mm	EG 1152	120 mm	125 mm	Compatible SLIFT, IME	



LIFTING • PADS & BLOCKS

← SCAN TO SEE OUR ENTIRE RANGE OF **LIFT PADS & BLOCKS** HERE

SBR rubber 85° SHORE A
Sold individually

Detailed schematics and dimensions on **clas.com**

	Libelles	Ref.	Ø interior	Ø exterior	Compatibility	
	TESLA PAD 3 Ø76/26 x h.51/25	EG 1153		76 mm		

Sold in multiples of 2 only

	Libelles	Ref.	
	LV BLOCK	EG 0607	

SBR rubber 85° SHORE A
Sold in multiples of 4 only

Detailed schematics and dimensions on **clas.com**

	Libelles	Ref.	
	RECTANGULAR RUBBER PAD 160x120x20mm	EG 1138	
	RECTANGULAR RUBBER PAD 160x120x30mm	EG 1137	
	RECTANGULAR RUBBER PAD 160x120x60mm	EG 1136	
	RECTANGULAR RUBBER PAD 160x120x115mm	EG 1143	
	PAD FIAT 500E/500X/JEEP RENEGADE Ø100 X H.55	EG 1154	





TE

1 SPEED

AUTOMATIC TIRE CHANGER 10"-24" 1 SPEED SYSTEM 230V

DM 1522

1-speed automatic tire changer with mounting aid (assistance arm)
Automatic tire changer specially adapted for the effortless mounting and dismounting of all car, utility and 4x4 tires.
Equipped with the bead pusher device with articulated bead pusher arm, adjustable to fit to each type of rim and tires.

For warranty purposes, installation and start-up must be performed by a professional.



+ Ideal for Run Flat or low-profile tires



AUTOMATIC TIRE CHANGER 10"-24" + WHEEL LIFT



1 SPEED SYSTEM

DM 0522

1 SPEEDS SYSTEM

DM 0501



2 SPEEDS

AUTOMATIC TIRE CHANGER 10"-24" 2 SPEED SYSTEM 400V

DM 1501

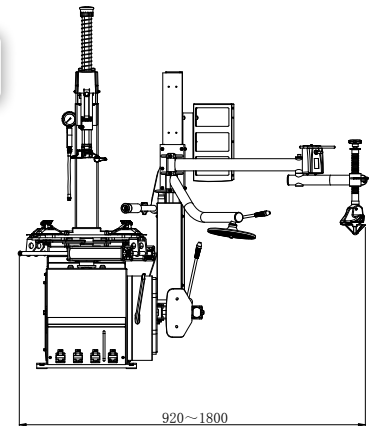
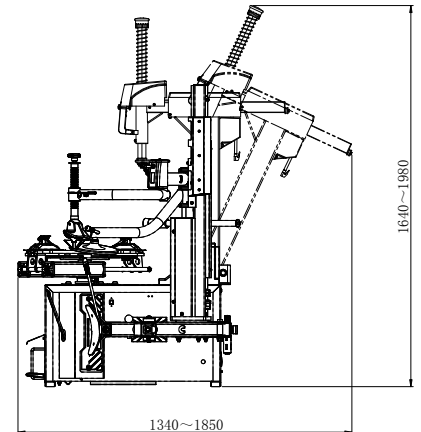

Specifications:

- roller-supported horizontal arm
- inflator with pressure gauge
- max. wheel diameter: 1180mm
- tire width: 3"-12"
- turntable with anti-pinch device
- outside clamp diameter: 10"-21"
- inside clamp diameter: 12"-24"
- turntable rotation speed: 6.5rpm
- 2 speeds without switch:
turntable rotation speed 1: 6.5rpm
turntable rotation speed 2: 13rpm
- ergonomic foot pedal
- adjustable 2 positions bead breaker blade with protection and double acting cylinder jack
- working air pressure: 8-10bar
- air cleaner and oil lubricator
- tubeless inflator safety valve: 3.5bar
- sound level < 70 dB
- power supply: 400V-50Hz
- power: 0.85-1.1kW
- bead breaker arm power: 2500kg
- dimensions: 1900x1580x2000mm

Comes with:

- SA8902: 5 protection pads
- SA8903: 5 protective clips
- SA8904: 1 blade protection cover 260x80mm
- SA8906: 4 pieces jaw cover set
- 1 lever with protection for alu rims

Options:

- DM1102: dual head quick fastening connection for alu/steel

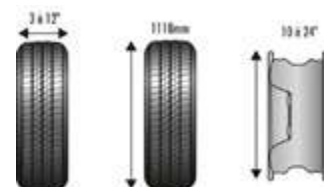



TIRE CHANGER WITH LEVERLESS 13-28" 2 SPEED SYSTEM 400V

DM 1900

2-speed automatic tire changer with mounting aid (assist arm) + pneumatic assistance on leverless stem.
Automatic tire changer specially designed for effortless mounting and demounting of all passenger car, commercial vehicle and 4x4 tires. Equipped with articulated bead lift and push device.

NEW



+ No effort, no use of exercise levers

Please consult us for installation and commissioning.
Under warranty, installation and commissioning must be carried out by a professional.

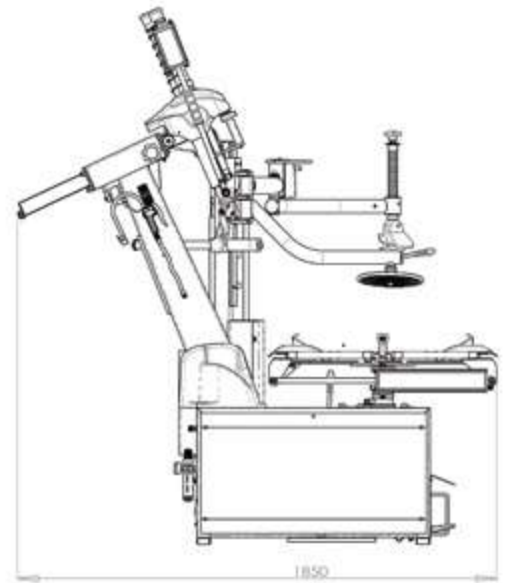
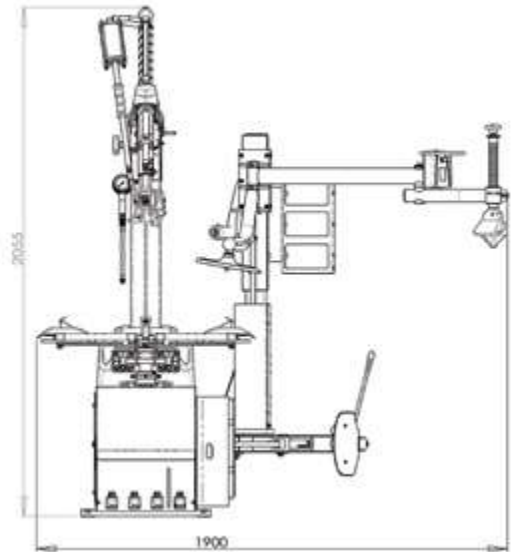

Specifications:

- horizontal arm moving on roller for easy translation
- jib equipped with leverless pneumatic finger
- inflator with pressure gauge
- maximum tire diameter: 1100mm
- max. tire width: 3 to 14 inches
- curved platform with anti-pinch safety device
- outer rim diameter: 13 to 24 inches
- inner rim diameter: 15 to 28 inches
- 2 speeds without switch :
rotation speed 1: 6.5 rpm
rotation speed 2: 13rpm
- ergonomic, intuitive pedals
- 2-position telescopic and swiveling take-off shovel with double-acting cylinder
- operating pressure: 8-10bar
- air cleaner and oil lubricator
- tubeless inflation safety valve: 3.5bar
- noise level < 70dB
- power supply: 400V-50Hz
- power: 0.85-1.1kW
- detent power: 2800kg
- dimensions: 1900x1580x2000mm

Supplied with:

- SA8902: 5 protective pads for steel heads
- SA8903: 5 protective clips for steel heads
- SA8904 : 1 protection shovel stripper
- SA8906: set of 4 aluminum rim protectors
- 1 tire changer with aluminum rim protector



TIRE CHANGER WITH LEVERLESS + WHEEL LIFTER

DM 0019

DM 0000



DM 0019





Find out more about our **truck tire machines** on **clas.com** here



DUAL HEAD QUICK FASTENING CONNECTION FOR ALU/STEEL

TN

DM 1102

Accessory of DM 1501/DM 1522/DM 0600BL/DM 1900

Allows plastic and steel heads to be changed thanks to the threaded-ring retaining system without tools.



Contents:

- female machine adaptor
- male adaptor for original head
- SA1190: plastic head
- fixing pin 28mm



ROLL PLATFORM FOR BEAD BREAKER

TN

DM 0200

Accessory of DM 2000/DM 1000/DM 1500/DM 0500BL/DM 0550BL/DM 1050/DM 1020/DM 1250/DM 1520/DM 1501/DM 1521/DM 0500BLP/DM 2000P/DM 0600BL

Easy wheel rotation while using the bead breaker. Attach to the ground at the same level as the detaching shovel.



SA 8901 STEEL HEAD REMOVAL ASSEMBLY

SA 1183 PLASTIC HEAD

WHEEL LIFTER FOR TIRE CHANGER

TE

DM 0000

Accessory of DM 1501/DM 1522/DM 2000/DM 0500BL/DM 1900/DM 0600BL

This tool, which works with most of the tire changers of the market, will allow you to work quickly and without any extra effort.

Thanks to its pneumatic foot-operated control, you can lift and rotate the wheel horizontally to position it on the tire changer table. Therefore, the operation of positioning the wheel on the table will be done easily with a minimum of physical effort, thereby limiting the risk of MSD (musculoskeletal disorders).



+ Ergonomic
Limits the risk of
MSD



Specifications:

- maximum load: 70kg
- max lifting height : 780mm
- platform width : 305mm





19L TIRE BEAD BLASTER CAR/LCV/HGV

TN

OP 0659



Specifications:

- steel tank 19l
- barrel width: 80mm
- discharge: valve (1.5") 1/4 turn
- handle in upper position
- pressure gauge 0-16bar
- safety valve 6.0bar
- working pressure: 7.5bar
- weight : 12kg

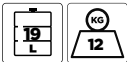

12L ALUMINUM AIR BLASTER/BAZOOKA

TN

OP 0679

Allows the tire bead to be placed on the wheel rim.

+ Light and ergonomics



Supplied with PU barrel and metal barrel

Specifications:

- aluminum tank 12L
- PU barrel, does not damage rims
- barrel width: 80mm
- 45° ergonomic handle
- pressure gauge 0-15bar
- 7.5bar safety valve
- operating pressure: 7.5bar
- weight: 4,05kg



18L ALUMINUM AIR BLASTER/BAZOOKA

TN

OP 0689

Allows the tire base to be positioned on the rim before inflation.

+ High capacity

NEW



Specifications:

- 18L aluminum tank
- 2 PU barrels, no damage to rims
- barrel width: 250mm
- height: 680mm
- ergonomic 45° handle
- pressure gauge 0-16bar
- 10.0bar safety valve
- operating pressure: between 6 and 8 bar
- weight: 13kg

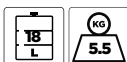



INFLATING GUN 0-12bar

OP 0046BL

B.LINE
BUDGET SOLUTION



Scale of 0 to 12 bar
Flexible length: 350mm



TN

INFLATOR GUN 0.7-12bar

OP 0049



- for passenger cars and vans.
- complies with directive 86/217/EEC
- standard UNI EN 12645
- graduations of 0.7 to 12bar



TN

4 MOTORBIKE JAW SET

DM 1104

Accessory of DM 2000/DM 0500BL/DM 1501/DM 1522/DM 0600BL/DM 1900



Installation on jaws with a max. width of 45mm.



TN

PLASTIC CHISEL

SA 0115

Spare part of OC 0112/OC 0113/EQ 0500BL/EQ 0600BL/EQ 1000/EQ 2100



TN

PRESS ASSIST DEVICE FOR LOW PROFILE OR RUN FLAT TIRES

DM 1101

Accessory of DM 2000/DM 1501/DM 1522/DM 0500BL/DM 0600BL/DM 1900

Easy positioning of the second tire bead.



TN

PLASTIC EDGE PROTECTOR FOR ALUMINUM RIMS

DM 0109

Accessory of DM 2000/DM 1501/DM 1522/DM 0500BL/DM 0600BL/DM 1900

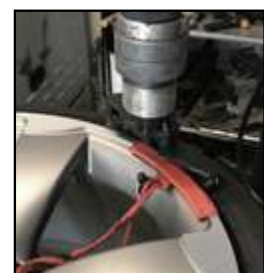

TN



TRANSLUCENT TIRE MOUNTING CREAM 5kg

DM 1303



+ Does not freeze in the pot

Specifications:

- non-irritating (chemically neutral)
- does not damage rubber
- does not damage paints
- suitable for any tire type



TN

Ø30mm ELBOW BRUSH FOR MOUNTING CREAM

DM 1306

Allows a more precise application while using the bead breaker.



+ Increased precision

Specifications:

- length: 270mm
- tough plant-based bristle
- wooden handle



TN



TIRE REMOVER SHEATHED L.495mm

OM 0255

Accessory of DM 2000/DM 0500BL/DM 1501/DM 1522/DM 0600BL/DM 1900

Allows to tires to be removed without causing damage to rims. The removable plastic base (6mm thick) is held by 4 screws on the steel part.

Specifications:

- Polycarbonate coating on the back side



+ Anti-scratch!

SA 0355 PROTECTIVE SHEATH



TN

2-IN-1 REVERSIBLE VALVE/ VALVE CORE REMOVAL

OM 7008



- Easy-grip resin handle
- Valve core removal tool
- Valve puller



TN

TIRE REMOVER L.650mm

OM 0259

Accessory of DM 2000/DM 0500BL/DM 1501/DM 1522/DM 0600BL/DM 1900



MOTORBIKE TIRE REMOVER WITH HANDLE L.425mm

DM 1305

Accessory of DM 1501/DM 1522/DM 2000/DM 0600BL/DM 1900





CHOOSE YOUR WHEEL BALANCER PROPERLY.

Points of vigilance

- use: intensive or occasional?
- tire dimension in your current process?

To consider:

You may wish to install a wheel lift assistant close to your machine to reduce MSD's (Musculoskeletal disorders).

Manual : Enter the offset, the rim width and the diameter on the keyboard. Perfect for occasional use or low volume tires.

Automatic : the measurements are detected and recognized by the machine. The automatic wheel balancers are supplied with a laser pointer which serves as a guide for positioning the balancing weight. Perfect for tire specialists or mounting centers

3D screen ?

The 3D screen allows a comfortable operation with visualization of the mass position on the screen. The information on the balancing in progress is accessible in real time.

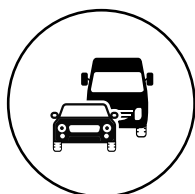

All of our wheel balancers are suitable with light vehicles, commercial vehicles and motorcycles.



The electromagnetic brake allows to stop the wheel directly at the right place, without manual adjustment.

OUR RANGE

REF	EQ 0600BL	EQ 1000	EQ 2100
Measurement of the 3 settings (offset, diameter, width)	Manual	Manual	Automatic
Electro-magnetic brake			•
Shaft diameter	40 mm	40 mm	40 mm
Shaft length	215 mm	210 mm	210 mm
LED inner rim light			•
Laser pointer (for weight positioning)			•
Wheel width	1 to 20"	Max 28"	Max 28"
Weight (kg)	87 kg	149 kg	149 kg
Connection	230V	230V	400V
Reparability			
The advantage		Multiple programs	Fast intervention



WHEEL BALANCERS

MANUAL MOTORIZED WHEEL BALANCER LED SCREEN

TE

EQ 0600BL

Wheel balancer designed for dynamic or static balancing of VL-VUL-4X4 wheels. The advantage of this machine is its modern, ergonomic design. The intuitive calibration system makes work easier and improves balancing accuracy. The machine is equipped with an LED display. Manual parameter entry.

B.LINE
BUDGET SOLUTION



NEW

Specifications:

- power supply: 230V-50Hz
- motor power: 180W
- dimensions open housing: 880x980x1420mm
- LED display
- maximum wheel weight: 65kg
- minimum rim diameter: 10 inches
- max rim diameter: 24 inches
- rim width: from 1 to 20 inches
- manual measurement of 3 parameters: offset-diameter-width
- safety housing
- rotation speed: 200 rpm
- compartmentalized tray for cones and weights
- 4 storage racks
- noise level <70dB
- weight: 87kg

Features :

- automatic cycle
- multifunction keys
- static and dynamic program (2 planes) in a single run
- 6 Alu programs (+ Optimization, Static, Motorcycle, Hidden weight)
- self-calibration
- self-diagnosis: fault code
- simultaneous display of weights and mass positions
- measurement accuracy: ±1g
- display accuracy: 5g





TE

MOTORIZED WHEEL BALANCER WITH DIGITAL DISPLAY

EQ 1000

Motorized wheel balancer equipped with a large digital display and manual measurement of 3 parameters for precise, simple and rapid work on wheels for LV, LCVs and 4x4s.

NOTE

Dimensions: see diagram of EQ 2100 p. 35



A wide range of programs

NOTE

EQ 1000 pack with wheel lift p.35



250mm
Facilitates the mounting of large offset rims

210mm
Long threaded shaft for easy mounting of various accessories

Functions:

- european software
- automatic cycle
- multipurpose keys
- static and dynamic program (dual plane) in a single measuring run
- 9 modes: 7 Alu (hidden weight)+Optimization+Motorcycle balancing
- automatic reset/Machine calibration: 50g weights
- auto diagnostic with error codes
- multiple operator function
- simultaneous display of weights and weight positions
- measuring precision: ±1g
- display precision: 1g/5g

Specifications:

- power supply voltage: 220V-50Hz
- dimensions (wheel guard opened): 1550x1160x1490mm
- sound level < 69dB
- digital display (automatic standby mode if the machine is not being in use after 5min)
- max. wheel diameter: 1100mm
- max. wheel weight: 70kg
- rim diameter: 1-28"
- rim width: 1.5-20"
- wheel 3 parameters manual measurement
- automatic wheel guard
- one balance time: 7s
- rotating speed: 140rpm
- shaft: L.210mm-Ø40mmx4mm
- ergonomic and functional weight holder top with large trays for different types of counterweights and tools.
- 4 storage media
- support of positioning weight
- weight: 149kg

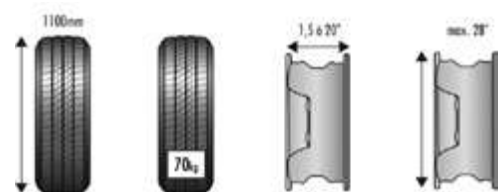

Supplied with:

- EQ6521BL: 4 counterweights from 42 to 137mm Ø40mm
- 12mm hex wrench
- SA8305: rim width caliper
- SA8905: calibration weight 50g
- OC8034: tire pliers
- EQ6404BL: fast nut Ø40x4mm with bowl/joint/compression ring





MUST-HAVE

AUTOMATIC WHEEL BALANCER 3D DIGITAL DISPLAY+LASER POINTER

EQ 2100

Motorized wheel balancer with a large digital display. Measures 3 parameters automatically for precise, simple and quick wheel balancing for cars, LCVs and 4x4s.

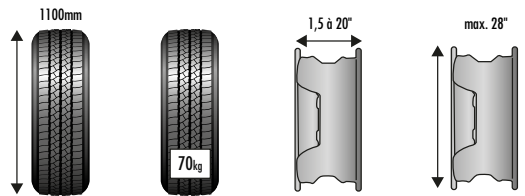

+ Laser pointer
Electromagnetic brake



Long threaded shaft for easy mounting of various accessories

250mm 210mm
Facilitates the mounting of large offset rims



- Supplied with:
- EQ6521BL: 4 counterweights from 42 to 137mm Ø40mm
 - 12mm hex wrench
 - SA8305: rim width caliper

- SA8905: calibration weight 50g
- OC8034: tire pliers
- EQ6404BL: fast nut Ø40x4mm with bowl/joint/compression ring



SA 8305



EQ 6521BL



OC 8034



EQ 6404BL



SA 8905



TE

Functions:

- european software
- automatic cycle
- multipurpose keys
- static and dynamic program (dual plane) in a single measuring run
- 9 modes: 7 Alu (hidden weight)
+Optimization+Motorcycle balancing
- automatic reset/machine calibration: 50g weights
- auto diagnostic with error codes
- multiple operator functions
- simultaneous display of weights and weight positions
- automatic stop on weight position with LED lighting inside the rim
- electromagnetic brake which can be locked if required
- measuring precision: ±1g
- display precision: 1g/5g

Specifications:

- power supply voltage: 220V-50Hz
- motor power: 90W
- dimensions (wheel guard opened): 1550x1160x1490mm
- sound level < 69dB
- digital display (automatic standby mode if the machine is not being used after 5min)
- max. wheel diameter: 1100mm
- max. wheel weight: 70kg
- max. rim diameter: 28"
- rim width: 1.5-20"
- automatically measures 3 parameters: protrusion, diameter, width
- laser pointer for mass positioning
- automatic wheel casing with automatic ignition
- duration of measurement cycle: 7s
- rotating speed: 140rpm
- shaft: L.210mm-Ø40mmx4mm
- ergonomic and functional weight holder top with large trays for different types of counterweights and cones.
- 4 storage media
- clip to position weights
- weight: 149kg

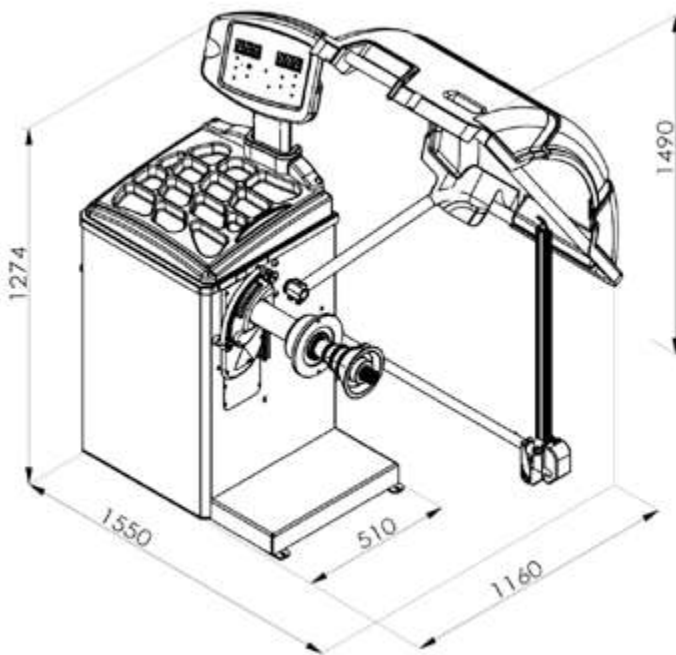

AUTOMATIC WHEEL BALANCER LASER POINTER + WHEEL LIFTER

EQ 0021

EQ 2100



EQ 0000



MOTORIZED WHEEL BALANCER WITH DIGITAL DISPLAY + WHEEL LIFTER

EQ 0010

EQ 1000



EQ 0000



TE





TN



MOTORBIKE KIT+Ø14mm SHAFT+CONES Ø16-34mm+RINGS Ø16mm

EQ 1634

Accessory of EQ 1000/EQ 2100/EQ 0600BL

Supplied with calibration weight 50g (SA8950)



SA 8950	CALIBRATION WEIGHT 50g FOR MOTORBIKE KIT	Spare part of EQ 1634
SA 1634	DEPORT EXTENSION FOR MOTO KIT	Spare part of EQ 1634



TE



EQ 6400BL CYLINDRICAL UNIVERSAL CENTERING PLATE Ø40mm

Accessory of EQ 1000/EQ 2100/
EQ 0600BL



EQ 6404BL QUICK NUT Ø40x4mm WITH BOWL/SEAL/
RING

Accessory of EQ 0600BL/EQ
1000/EQ 2100



SA 8305 RIM WIDTH CALIPER

Accessory of EQ 0500BL/EQ
1000/EQ 2100/EQ 0600BL



OC 8034 MULTIFUNCTIONAL TIRE PLIERS



EQ 6521BL 4 CENTERING CONE SET Ø40mm from 40 to
137mm

Accessory of EQ 1000/EQ 2100/
EQ 0600BL



EQ 8093 LCV CENTERING CONE Ø118-174mm+SPACER
DISK Ø40mm KIT

Accessory of EQ 1000/EQ 2000/
EQ 1050/EQ 2100/EQ 0600BL



WHEEL LIFTER FOR WHEEL BALANCER

EQ 0000

Accessory of EQ 1000/EQ 2100/EQ 0500BL/EQ 0600BL

+ Ergonomic
Limits the risk of MSD



TE





WHEEL & TIRE HANDLING

ELECTRIC & RECHARGEABLE WHEEL LIFTER MAX. 60kg

OE 9000

Allows wheels for cars, LCVs and 4x4s to be effortlessly lifted to the height of the vehicle on the ramp.
Allows wheels to be moved around the workshop.
Low center of gravity increases stability.



+ Compatible with scissor lifts



Specifications:

- lifting capacity: 60kg
- wheels 135/80 R13 to 295/25 R22
- max height of the hub: 145cm
- up/down control integrated in the handle
- lifting speed: 0.14m/s
- lifting system-motorized screw
- 4 swiveling wheels for greater maneuverability
- anti-fall security feature
- emergency stop button
- reels to facilitate rotation to position the wheel on the hub
- IED indicators:
 - Battery charge level
 - Max. charge capacity exceeded
 - emergency stop function deployed
 - engine temperature of the upper screw
 - batteries 12V 12Ah
 - charger: 220V-AC
 - dimensions: L.725xW.800xH.1710mm

Limits the risks of accident
Lifts wheels effortlessly



DISPLAY TIRES

EG 0112

+ Up to 10 tires

Specifications:

- support for up to 10 tires
- metal
- 2 braked wheels
- level height 760mm
- interaxial 450mm
- dimensions: L.1060xW.510xH.1910mm

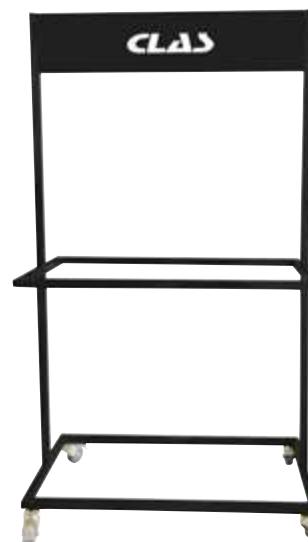



WHEEL LIFTER HGV

OH 9001

+ Secured wheel

Mounted on 3 swiveling wheels
Lifts wheel using hydraulic piston (max. 650kg)

Specifications:

- length: 1161mm
- width: mini-maxi 2080x565x1500mm or 1161x565x1500mm
- ground clearance: 150mm

Max. Kg
650

2
WARRANTY



TIRE REMOVER HGV

OM 9002

+ Reduces MSD.

The lifting dolly is the easiest and safest way to install and uninstall the wheels of LCV and HGV vehicles.

It uses simple leverage principles so that the user provides as little physical effort as possible.
This cart allows the user to use their body weight to push the handle down to relieve the wheel from the studs.

Easy installation and removal of truck wheel/tire assemblies
3 positions for the rollers according to the size of the tyres
Prevents damage to wheel studs
For all wheels from 6.5" to 24.5".

Specifications:

- arm width: 500mm
- depth: 350mm

Max. Kg
250

2
WARRANTY



WHEEL LIFTER HGV/PUBLIC WORKS/AGRICULTURAL

OH 9000

+ Wide wheel compatible

Wheel lifting by hydraulic cylinder (1200kg maximum).

Specifications:

- height: min.1375mm-max.2175mm
- length: 940mm
- width: min.1200mm-max.1970mm
- ground clearance: 175mm
- roller length: 500mm
- space between rollers: min.720mm-max.1250mm
- rollers: Ø76mm
- capacity wheel Ø: min.1000mm-max.2200mm
- depth of wheels: 800mm maximum
- dolly wheels: 4 big wheels PU Ø145x50mm including 2 swivel wheels with brakes

Max. T
12
↑ 2175
↓ 1375
mm

2
WARRANTY



CHOOSE YOUR COMPRESSOR PROPERLY.

Key points to consider:

There are different types of compressors, the choice depends on the expected use and/or the number of devices to be supplied.



- use: private, professional, tire specialist...?
- technology?
- engine power?

TO CONSIDER :

1m³/h = 16.67 l/min

To calculate the required air flow, multiply the consumption of your tools by 1.5.

EXPERT ADVICE

- **Dryer**
Required when using tools that require dry air such as painting tools. The dryer should be selected according to the flow rate of the applied compressor.
- **Filtration**
Required for the system depolluting, used for painting applications. The filters should only be used with a dryer. Service: annual filter replacement.

THE DIFFERENT TYPES OF COMPRESSORS



PISTON AIR COMPRESSORS

- Direct or coaxial drive: the head is directly powered by the engine. An economical solution for occasional use.
- Belt drive: Independent engine and compressor. Possibility of low-speed operation and soundproofed version.
- Intermittent use.

+ Economical, wide range of choices



SCREW AIR COMPRESSORS

- Regular use at a constant flow rate.
- Reduced mechanical strain and friction, which makes it more robust.
- Powerful and quiet.

+ Durable

REF	Technology	Capacity	Engine power (CV)	Pressure (bar)	Flow rate (l/min)	Use
OP 6253	piston	20 L	1.5	10	230	Industrial
OP 6254	piston	20 L	2.5	10	460	
OP 6255	piston	20 L	2	10	280	
OP 3603	piston	50 L	2	8	240	Private
OP 3600	piston	100 L	3	10	320	Additional or mobile use
OP 3601	piston	150 L	3	10	320	
OP 3602	piston	200 L	3	10	320	Professional: 1 companion
OP 3604	piston	270 L	5.5	11	650	Professional: 2 to 3 companions
OP 3605	piston	500 L	5.5	11	600	Professional: 3+ companions
OP 3606	piston	500 L	10	11	1100	
OP 3612	piston	270 L	7.5	11	850	
OP 3608	piston	-	7.5	11	850	
OP 3606	piston	500 L	10	11	1182	
OP 3609	piston	-	10	11	1182	
OP 3610	screw	500 L	15	10	1500	Tire & body specialists
OP 3622	screw	500 L	10	10	1000	
OP 3611	screw	-	20	10	2000	



PISTON AIR COMPRESSORS

TE

Two-cylinder piston compressor, ideal for working in special environments where no lubricant is required.

Allows continuous dry air operation with very little maintenance.

+ Hand truck size, ideal for outdoor use



+ Heavy duty industrial application

AIR COMPRESSOR UNLUBRICATED 20L 1.5HP OP 6253

Specifications:

- tank: 20L
- ventilated cooling
- 1450 rpm
- volume generated: 230l/min
- max pressure: 10bar
- engine power : 1.5hp-1.1kW
- twin-cylinder
- power supply : mono 230V
- weight : 33kg

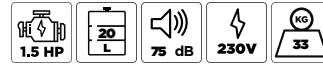

AIR COMPRESSOR UNLUBRICATED 20L 2.5HP OP 6254

Specifications:

- tank: 20L
- ventilated cooling
- 2850 rpm
- volume generated: 460l/min
- max pressure: 10bar
- engine power : 2.5hp-1.8kW
- twin-cylinder
- power supply : mono 230V
- weight : 34kg

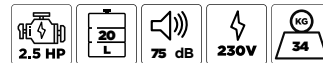

AIR COMPRESSOR UNLUBRICATED 20L 2HP

OP 6255

Three-cylinder piston compressor, ideal for working in special environments where no lubricant is required.

Allows continuous dry air operation with very little maintenance.

Specifications:

- tank: 20L
- ventilated cooling
- 1450 rpm
- volume generated: 280l/min
- max pressure: 10bar
- engine power : 2hp-1.8kW
- three-cylinder
- power supply : mono 230V
- weight : 38kg

+ Hand truck size, ideal for outdoor use

+ Heavy duty industrial application





TE

AIR COMPRESSOR 50I 2HP

OP 3603

+ Mobile

Specifications:

- volume generated: 240l/min
- 2850 rpm
- max pressure: 8bar
- engine power: 2cv-1.5kW
- power supply: mono 230V
- cast iron group
- handle for manipulation
- purifier regulator



2
WARRANTY



AIR COMPRESSOR 100I 3HP

OP 3600

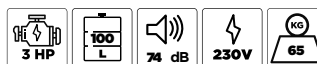

2
WARRANTY



AIR COMPRESSOR 150I 3HP

OP 3601



2
WARRANTY

Specifications:

- belt drive
- volume generated: 320 l/min
- 1500 rpm
- max pressure: 10bar
- engine power: 3cv-2.2kW
- twin-cylinder
- electrical supply: mono 230V
- equipped with regulator
- visible oil level

+ Mobile

AIR COMPRESSOR 200I 3HP

OP 3602

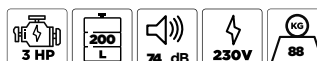

2
WARRANTY

AIR COMPRESSOR 270I 5.5HP

OP 3604

+ Soundproof

Specifications:

- slow running
- belt drive
- 1150 rpm
- volume generated: 650l/min
- max pressure: 11bar
- engine power: 5.5hp-4kW
- twin-cylinder
- electrical supply: tri 400V



2
WARRANTY



SPECIALIST SYNTHETIC OIL FOR PISTON COMPRESSORS (2L)

OP 6814



NO
WARRANTY

TN



TE



BELT COMPRESSOR 500l 7.5HP

OP 3605

Specifications:

- belt drive
- dual cooling collectors for maximum efficiency
- 1450 rpm
- volume generated: 600l/min
- max pressure: 11bar
- engine power: 5.5hp-4kW
- twin-cylinder
- electrical supply: tri 400V

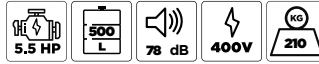

COMPRESSOR SPEED 500l 10HP

OP 3606

Specifications:

- belt drive
- dual cooling collectors for maximum efficiency
- 1100 rpm
- volume generated: 1182l/min
- max pressure: 11bar
- engine power: 10hp-7.5kW
- twin-cylinder
- electrical supply: tri 400V

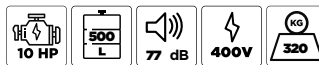

SILENT BELT COMPRESSOR 7.5HP

OP 3608

Specifications:

- belt drive
- integrated 3-litre tank mounted on vibration dampers
- dual electric ventilators with thermostatic control
- easily readable hour counter
- 1150 rpm
- volume generated: 850 l/min
- max pressure: 11bar
- engine power: 7.5hp-5.5kW
- twin-cylinder
- electrical supply: tri 400V



SILENT BELT COMPRESSOR 10HP

OP 3609

Specifications:

- belt drive
- integrated 3-litre tank mounted on vibration dampers
- dual electric ventilators with thermostatic control
- easily readable hour counter
- 1100 rpm
- volume generated: 1182 l/min
- max pressure: 11bar
- engine power: 10hp-7.5kW
- twin-cylinder
- electrical supply: tri 400V

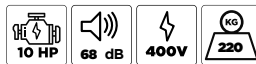

MUST-HAVE

TE

VERTICAL COMPRESSOR 270l 7.5HP

OP 3612

Specifications:

- belt drive
- 1150 rpm
- volume generated: 850 l/min
- max pressure: 11bar
- engine power: 7.5hp-5.5kW
- twin-cylinder
- electrical supply: tri 400V



+ Low space requirement





SCREW AIR COMPRESSORS



TE

The screw compressor will allow you to work with a maximum of air for a minimum of energy consumption. This solution has a long service life and we recommend it for intensive use.

The compressor has been designed to operate continuously under the most demanding conditions of use: tire operators, multiple journeymen, extensive air networks, numerous downpipes and end connections...

Particular attention has been paid to the design of this equipment in order to respond to daily problems: low maintenance costs and ease of use.

+ Long life in intensive use



SCREW AIR COMPRESSOR 10HP

OP 3622

Specifications:

- 1000 l/min
- tank: 500L
- air dryer included
- max pressure: 10bar
- motor power: 10cv-7.5kW
- power supply: tri 400V



AIR COMPRESSOR 15HP ON TANK + DRYER

OP 3610

Specifications:

- volume generated: 1500 l/min
- tank: 500L
- dryer included
- max pressure: 10bar
- engine power: 15hp-11kW
- electrical supply: tri 400V



AIR COMPRESSOR 20HP

OP 3611

+ Long life in intensive use



Specifications:

- volume generated: 2000 l/min
- max pressure: 10bar
- engine power: 20hp-15kW
- electrical supply: tri 400V

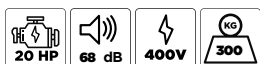

SPECIAL SYNTHETIC OIL FOR SCREW COMPRESSORS (5L)

OP 6813



TN





TE

VERTICAL TANK



Storage in a wet environment

Our tanks are equipped with safety valves and standard pressure gauges. Sets of plugs, fittings and hoses are available on request and should only be specified when ordering.



REF	OP 3620	OP 3621
Capacity	270 L	500 L
Pressure (bar)	11	11
Diameter	ø 490mm	ø 600mm
Height (mm)	ø 1660	ø 2060
Weight (kg)	63.5	125



REF	OP 3613
Capacity	270 L
Pressure (bar)	11
Diameter	ø 600mm
Height (mm)	ø 2060
Weight (kg)	125



DRYER 900I

OP 3615

Specifications:

- 16 bar
- dimensions: 250x660x460mm
- weight: 24kg



Energy saving

Air refrigerator dryer with aluminum-copper heat exchanger for perfect operating, with 'Energy Saving' technology.



DRYER 1200I

OP 3616

Specifications:

- 16 bar
- dimensions: 250x660x460mm
- weight: 25kg



DRYER 2500I

OP 3617

Specifications:

- 16 bar
- dimensions: 250x660x460mm
- weight: 29kg

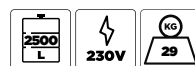

TN



3/4" CONNECTION HOSE

OP 3618

1" CONNECTION HOSE

OP 3619





CHOOSE YOUR AIR PIPE AND FITTING KIT PROPERLY.

Key points to consider

- air pipe material?
- air pipe diameter to suit your needs?
- number of companions?
- number of downpipes wished?

Many tools use air to operate.



Air pressure that is too low considerably reduces the performance of most pneumatic tools, which are generally made to operate at a pressure of 6.3 bar: lower pressure reduces tool efficiency and decreases productivity.

The common issue is the need to have several air channels, which correspond to different tools and/or uses.

To consider:

Set up your main network as a "closed loop" in order to limit pressure drops.

EXPERT ADVICE

The choice of material has a significant influence on the flexibility, weight, performance and Durable of the air pipe.

If the pipe material is not adapted to the workplace conditions, the pipe will quickly break down or underperform.

DIFFERENT MATERIALS



PVC

- + Economical
- Tricky to set up
Weak: expansion, risk of leaking. Permanent set up (glued)

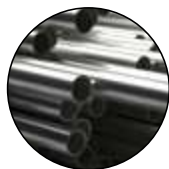

STEEL

- + Durable
High mechanical resistance
- Set up by a professional
Risk of leaking screw connection
Permanent set up

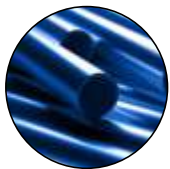

ALUMINUM

- + Easy to install and use
Lightweight, adjustable size
High mechanical resistance, durable



This is the ultimate setup for workshops!

HOW TO CHOOSE

YOUR COMPRESSOR				NETWORK SIZE			Nb of companions	CLAS SOLUTIONS			
Power		Air flow rate		Lenght & Diameter				REF			
kW	CV	l/min	m3/h	50m	100m	150m	KR 2016	KR 3020	KR 4425	KR 6032	
2,2	3	250	15	Ø16	Ø16	Ø20	•				
4	5	450	27	Ø20	Ø20	Ø20		•			
5,5	7,5	600	36	Ø20	Ø20	Ø25		•			
7,5	10	800	48	Ø20	Ø25	Ø25			•		
11	15	1500	90	Ø25	Ø25	Ø32			•		
15	20	2000	120	Ø25	Ø32	Ø32			•	•	



AIR PIPE AND FITTING KITS

ALUMINUM AIR PIPE AND FITTING KIT Ø16mm L.20m 3 DOWNPIPES

KR 2016

Aluminum components for tubes, and technopolymer fittings make this system a safe, durable network, with no risk of corrosion or pipe deformation. Economical, thanks to its quick assembly: no gluing, no welding or crimping, works by interlocking, locking. High adaptability with these multiple connectors, and by its compatibility for existing network recovery.

The kit can be modulated at any time and allows an economic projection at any time (estimate not essential).
Mounting accessories: see website.



TN



+ Plug and play

- recommendation: 7.5HP
- working pressure: 13 bar / 190 psi

COMPOSITION

	ALUMINUM PIPE Ø16mm LENGTH 4M	10		COMPOSITE TAPERED MALE THREADED STRAIGHT FITTING Ø16xM1/2" G	3
	COMPOSITE SLEEVE Ø16mm	5		ALUMINUM FEMALE WALL BRACKET 1/2"x1/2" G	3
	SET OF 10 CLAMP 16mm M8	2		THREAD CONNECTION FLEXIBLE 16x1/2"	2M
	COMPOSITE ELBOW 90° FOR Ø16mm	3		MALE THREADED VALVE Ø16mm 1/2" G	1
	EQUAL COMPOSITE TEE Ø16mm	2		SPECIAL WRENCH NUT TIGHTENING Ø16 TO Ø20	1

THINK ABOUT IT !

FAST CONNECTOR PASSAGE 6mm MALE 1/2"

OP 0706



TN





ALUMINUM AIR PIPE AND FITTING KIT Ø20mm L.30m 4 DOWNPIPES

TN

KR 3020

Aluminum components for tubes, and technopolymer fittings make this system a safe, durable network, with no risk of corrosion or pipe deformation. Economical, thanks to its quick assembly: no gluing, no welding or crimping, works by interlocking, locking. High adaptability with these multiple connectors, and by its compatibility for existing network recovery.

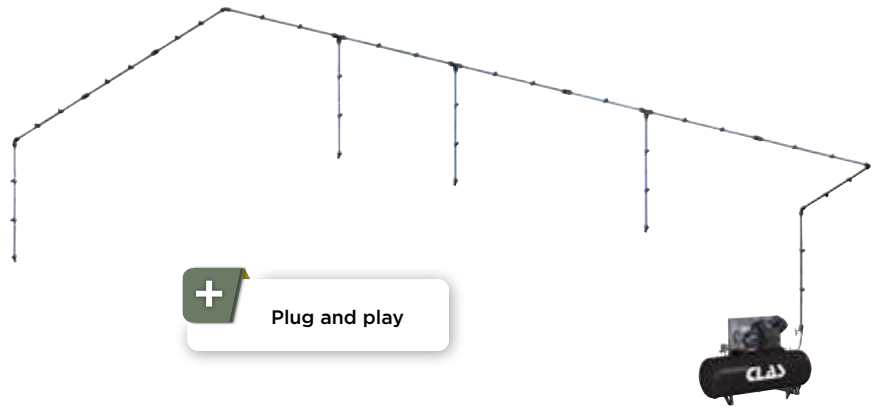

+ Plug and play

Recommended: 5HP or 7.5HP compressor

COMPOSITION

	ALUMINUM PIPE Ø20mm LENGTH 2m	15		COMPOSITE TAPERED MALE THREADED STRAIGHT FITTING Ø20xM1/2"G	4
	COMPOSITE SLEEVE Ø20mm	5		APPLIQUE À SORTIE TARAUDÉE	3
	10 CLAMP SET 20mm M8	3		THREADED CONNECTION HOSE 16x1/2"	2M
	COMPOSITE ELBOW 90° FOR Ø20mm	4		VALVE FOR PIPE Ø25 FEMALE THREADED F 3/4 "G	1
	EQUAL COMPOSITE TEE Ø20mm	3		SPECIAL WRENCH NUT TIGHTENING Ø16 TO Ø20	1



ALUMINUM AIR PIPE AND FITTING KIT Ø25mm L.36m 5 DOWNPIPES

TN

KR 4425

Aluminum components for tubes, and technopolymer fittings make this system a safe, durable network, with no risk of corrosion or pipe deformation. Economical, thanks to its quick assembly: no gluing, no welding or crimping, works by interlocking, locking. High adaptability with these multiple connectors, and by its compatibility for existing network recovery.

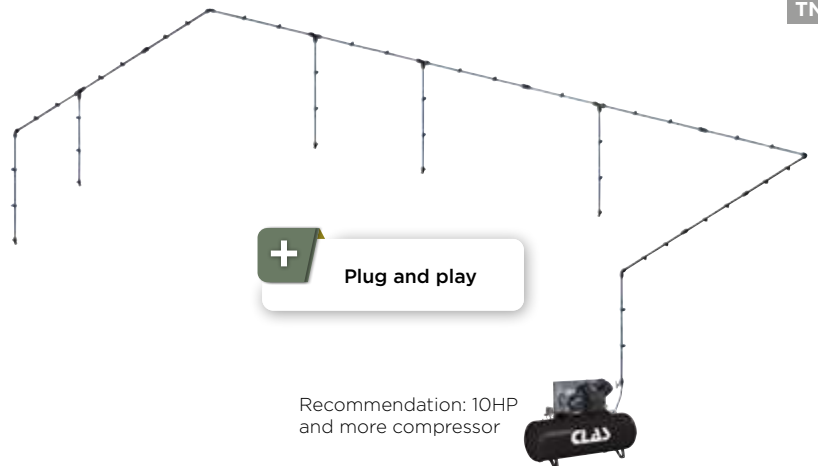

+ Plug and play

Recommendation: 10HP and more compressor

COMPOSITION

	ALUMINUM PIPE Ø25mm LENGTH 4M	18		CAP Ø25mm	1
	ALUMINUM PIPE Ø20mm LENGTH 2m	5		COMPOSITE TAPERED MALE THREADED STRAIGHT FITTING Ø25x1/2 "G	1
	COMPOSITE SLEEVE Ø25mm	9		ALUMINIUM FEMALE WALL BRACKET	5
	10 CLAMP SET 25mm M8	4		THREADED CONNECTION HOSE 3/4" M x3/4" F	2M
	10 CLAMP SET 20mm M8	1		VALVE FOR PIPE Ø25 FEMALE THREADED F 3/4 "G	1
	COMPOSITE ELBOW 90° FOR Ø25mm	5		SPECIAL WRENCH NUT TIGHTENING Ø16 TO Ø20	1
	COMPOSITE TEE REDUCED ON CENTER Ø25X20	5		SPECIAL WRENCH NUT TIGHTENING Ø25 TO Ø32	1
	EQUAL COMPOSITE TEE Ø25mm	1			





ALUMINUM AIR PIPE AND FITTING KIT Ø32mm L.60m 8 DOWNPIPES

KR 6032

Aluminum components for tubes, and technopolymer fittings make this system a safe, durable network, with no risk of corrosion or pipe deformation. Economical, thanks to its quick assembly: no gluing, no welding or crimping, works by interlocking, locking. High adaptability with these multiple connectors, and by its compatibility for existing network recovery.



+ Plug and play

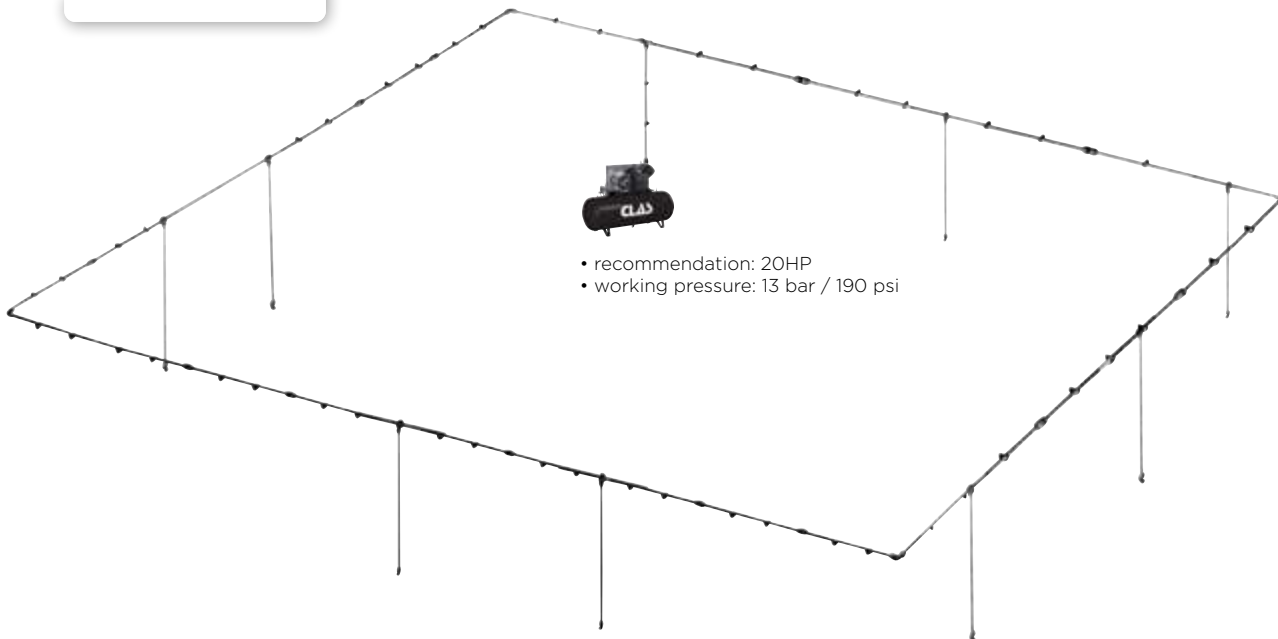

- recommendation: 20HP
- working pressure: 13 bar / 190 psi



NOTE
Pneumatic solutions p.94
and reels p.89

COMPOSITION

	ALUMINUM PIPE Ø32mm LENGTH 4m	30	KR 7038
	ALUMINUM PIPE Ø20mm LENGTH 4M	8	KR 7036
	COMPOSITE SLEEVE Ø32mm	15	KR 7017
	10 CLAMP SET 32mm M8	3	KR 7012
	10 CLAMP SET 20mm M8	2	KR 7010
	COMPOSITE ELBOW 90° FOR Ø32mm	6	KR 7007
	COMPOSITE TAPPING FLANGE FOR PIPE Ø32xØ20	8	KR 7046

	EQUAL COMPOSITE TEE Ø32mm	2	KR 7076
	CAP Ø32mm	1	KR 7025
	MULTICOUCH HOSE	2M	
	FLEXIBLE LINK Ø32mm	1	KR 7031
	PIPPING VALVE Ø32	1	KR 7058
	SPECIAL WRENCH NUT TIGHTENING Ø16 TO Ø20	1	KR 7054
	SPECIAL WRENCH NUT TIGHTENING Ø25 TO Ø32	1	KR 7055

THINK ABOUT IT !

FAST CONNECTOR PASSAGE 6mm MALE 1/2"

OP 0706



TN



60 m



5 WARRANTY



AIR PIPE AND FITTING PARTS

TN



ALUMINUM PIPE 4M

KR 7035	ALUMINUM PIPE Ø16mm LENGTH 4M
KR 7036	ALUMINUM PIPE Ø20mm LENGTH 4M
KR 7037	ALUMINUM PIPE Ø25mm LENGTH 4M
KR 7038	ALUMINUM PIPE Ø32mm LENGTH 4m
KR 7039	ALUMINUM PIPE Ø40mm LENGTH 4M



CLAMP M8

KR 7009	SET OF 10 CLAMP 16mm M8
KR 7010	10 CLAMP SET 20mm M8
KR 7011	10 CLAMP SET 25mm M8
KR 7012	10 CLAMP SET 32mm M8
KR 7013	10 CLAMP SET 40mm M8



COMPOSITE SLEEVE

KR 7014	COMPOSITE SLEEVE Ø16mm
KR 7015	COMPOSITE SLEEVE Ø20mm
KR 7016	COMPOSITE SLEEVE Ø25mm
KR 7017	COMPOSITE SLEEVE Ø32mm
KR 7018	COMPOSITE SLEEVE Ø40mm



COMPOSITE ELBOW 90°

KR 7004	COMPOSITE ELBOW 90° FOR Ø16mm
KR 7005	COMPOSITE ELBOW 90° FOR Ø20mm
KR 7006	COMPOSITE ELBOW 90° FOR Ø25mm
KR 7007	COMPOSITE ELBOW 90° FOR Ø32mm
KR 7008	COMPOSITE ELBOW 90° FOR Ø40mm



COMPOSITE ELBOW 45°

KR 7000	COMPOSITE ELBOW 45° FOR Ø20mm
KR 7001	COMPOSITE ELBOW 45° FOR Ø25mm
KR 7002	COMPOSITE ELBOW 45° FOR Ø32mm
KR 7003	COMPOSITE ELBOW 45° FOR Ø40mm



COMPOSITE TAPPING FLANGE

KR 7043	COMPOSITE TAPPING FLANGE FOR PIPE Ø25xØ16
KR 7044	COMPOSITE TAPPING FLANGE FOR PIPE Ø25xØ20
KR 7045	COMPOSITE TAPPING FLANGE FOR PIPE Ø32xØ16
KR 7046	COMPOSITE TAPPING FLANGE FOR PIPE Ø32xØ20
KR 7047	COMPOSITE TAPPING FLANGE FOR PIPE Ø40xØ16
KR 7048	COMPOSITE TAPPING FLANGE FOR PIPE Ø40xØ20
KR 7049	COMPOSITE TAPPING FLANGE FOR PIPE Ø40xØ25



CAP

KR 7022	CAP Ø16mm
KR 7023	CAP Ø20mm
KR 7024	CAP Ø25mm
KR 7025	CAP Ø32mm
KR 7026	CAP Ø40mm



EQUAL COMPOSITE TEE

KR 7073	EQUAL COMPOSITE TEE Ø16mm
KR 7074	EQUAL COMPOSITE TEE Ø20mm
KR 7075	EQUAL COMPOSITE TEE Ø25mm
KR 7076	EQUAL COMPOSITE TEE Ø32mm
KR 7077	EQUAL COMPOSITE TEE Ø40mm



COMPOSITE TEE REDUCED ON CENTER

KR 7063	COMPOSITE TEE REDUCED ON CENTER Ø20X16
KR 7064	COMPOSITE TEE REDUCED ON CENTER Ø25X16
KR 7065	COMPOSITE TEE REDUCED ON CENTER Ø25X20
KR 7066	COMPOSITE TEE REDUCED ON CENTER Ø32X20
KR 7067	COMPOSITE TEE REDUCED ON CENTER Ø40X20
KR 7068	COMPOSITE TEE REDUCED ON CENTER Ø40X25



COMPOSITE TAPERED THREADED STRAIGHT FITTING

KR 7081	COMPOSITE TAPERED MALE THREADED STRAIGHT FITTING Ø16xM1/2"G
KR 7082	COMPOSITE TAPERED MALE THREADED STRAIGHT FITTING Ø20xM1/2"G
KR 7083	COMPOSITE TAPERED MALE THREADED STRAIGHT FITTING Ø20xM3/4"G
KR 7084	COMPOSITE TAPERED MALE THREADED STRAIGHT FITTING Ø25x1"G
KR 7085	COMPOSITE TAPERED MALE THREADED STRAIGHT FITTING Ø25x1/2"G
KR 7086	COMPOSITE TAPERED MALE THREADED STRAIGHT FITTING Ø25x3/4"G
KR 7087	COMPOSITE TAPERED MALE THREADED STRAIGHT FITTING Ø32x1"G
KR 7088	COMPOSITE TAPERED MALE THREADED STRAIGHT FITTING Ø32x1"1/4G
KR 7089	COMPOSITE TAPERED MALE THREADED STRAIGHT FITTING Ø40x1"G
KR 7090	COMPOSITE TAPERED MALE THREADED STRAIGHT FITTING Ø40x1"1/2G
KR 7091	COMPOSITE TAPERED MALE THREADED STRAIGHT FITTING Ø40x1"1/4G



THREADES WALL BRACKET

KR 7033	THREADED ALUMINUM WALL LIGHT IN-OUT-F1/2G
KR 7034	THREADED ALUMINUM WALL LIGHT IN-OUT-F3/4G
KR 7069	ALUMINUM FEMALE WALL BRACKET 1/2"x1/2"G
KR 7070	ALUMINUM FEMALE WALL BRACKET Ø20x1/2"G
KR 7071	ALUMINUM FEMALE WALL BRACKET Ø22x1/2"G
KR 7072	ALUMINUM FEMALE WALL BRACKET Ø25x3/4"G
KR 7078	ALUMINUM WALL MOUNTING 3 THREADS F1/2"G WITH 1/4" PRE-DRILL PURGE
KR 7079	ALUMINUM WALL MOUNTING 1 SUPPLY THREAD F1/2"G x2 EXITS F1/2"G WITH 1/4" PRE-DRILL PURGE
KR 7080	ALUMINUM WALL MOUNTING 1 SUPPLY THREAD F3/4"G x2 EXITS WITH 1/4" PRE-DRILL PURGE





FLEXIBLE LINK

TN

- KR 7030 FLEXIBLE LINK Ø25mm
- KR 7031 FLEXIBLE LINK Ø32mm
- KR 7032 FLEXIBLE LINK Ø40mm



ALUMINUM DIVERSION FOR DOWNPIPE

TN

- KR 7019 ALUMINUM DIVERSION FOR DOWNPIPE Ø20mm L.500mm
- KR 7020 ALUMINUM DIVERSION FOR DOWNPIPE Ø25mm L.500mm
- KR 7021 ALUMINUM DIVERSION FOR DOWNPIPE Ø16mm L.500mm

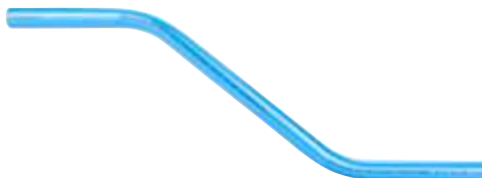

THREADED VALVE

TN

- KR 7060 1" WALL MOUNTING VALVE FOR PIPE Ø25
- KR 7061 1 1/2" WALL MOUNTING VALVE FOR PIPE Ø32
- KR 7062 1 1/2" WALL MOUNTING VALVE FOR PIPE Ø40



VALVE FOR PIPE F

PIPPING VALVE Ø32

- KR 7027 MALE THREADED VALVE Ø16mm 1/2 "G
- KR 7050 VALVE FOR PIPE Ø20 FEMALE THREADED F 1/2 "G
- KR 7051 VALVE FOR PIPE Ø25 FEMALE THREADED F 3/4 "G
- KR 7052 VALVE FOR PIPE Ø20 MALE THREADED 1/2 "G
- KR 7053 VALVE FOR PIPE Ø25 MALE THREADED 3/4 "G
- KR 7057 PIPPING VALVE Ø25
- KR 7058 PIPPING VALVE Ø32
- KR 7059 PIPPING VALVE Ø40



VALVE FOR PIPE M



PIPPING VALVE Ø32



SPECIAL WRENCH NUT TIGHTENING

TN

- KR 7054 SPECIAL WRENCH NUT TIGHTENING Ø16 TO Ø20
- KR 7055 SPECIAL WRENCH NUT TIGHTENING Ø25 TO Ø32
- KR 7056 SPECIAL WRENCH NUT TIGHTENING Ø40 TO Ø50



**CHAMFERING TOOL
Ø16mm TO Ø50mm**

TN

KR 7040



**PIPE INSERTION
CONTROL GAUGE Ø16mm
TO Ø50mm**

TN

KR 7041



**SILICONE FREE ASSEMBLY
GEL**

TN

KR 7042





WORKBENCHES

1.5m WORKBENCH SET

EG 0311

+ Hight weight capacity 700kg

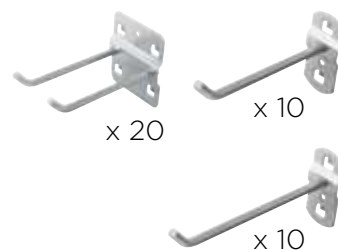
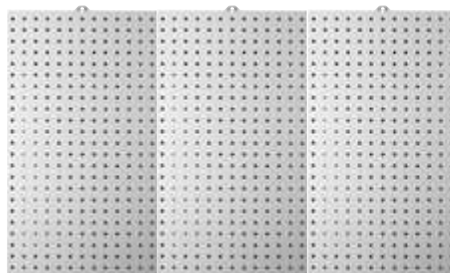

Dimensions:

- wooden trays: L.1500xI.750xH.30mm
- framework: L.1410xI.692xH.855mm
- storage (metal plate): L.1410xI.610mm
- weight: 95kg

- EG0335 : 1 x metal workbench wooden tray 1.5m
- EG0337 : 1 x drawer
- EG0344 : 2 x bag of 10 double hooks ø6mm I.50mm
- EG0346 : 1 x bag of 10 simple hooks ø6mm I.50mm
- EG 0347 : 1 x bag of 10 double hooks ø6mm I.100mm
- EG0357 : 3 x perforated panel tool rack 500x900x30mm

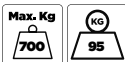

TN

2m WORKBENCH SET

EG 0312

+ Hight weight capacity 700kg

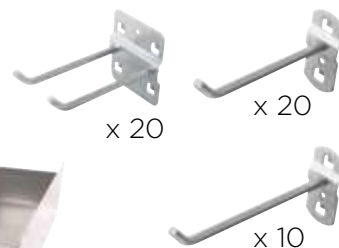
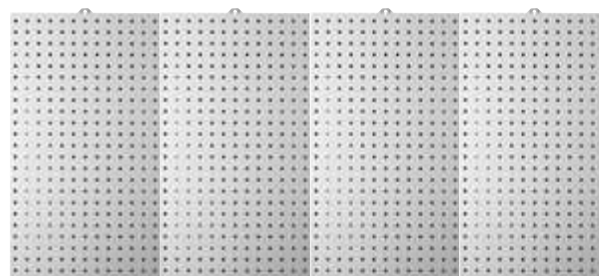

Dimensions:

- wooden trays: L.2000xI.1740xH.30mm
- framework: L.1900xI.692xH.855mm
- storage (metal plate): L.1900xI.610mm
- weight: 120kg

- EG0336 : 1 x metal workbench wooden tray 2m
- EG0357 : 4 x perforated panel tool rack 500x900x30mm
- EG0344 : 2 x bag of 10 double hooks ø6mm I.50mm
- EG0346 : 2 x bag of 10 simple hooks ø6mm I.50mm
- EG0347 : 1 x bag of 10 double hooks ø6mm I.100mm
- EG0337 : 2 x drawer

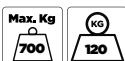

TN



TN



METAL WORKBENCH WOODEN TRAY 1.5m

EG 0335

Dimensions:

- wooden trays: L.1500xI.750xH.30mm
- framework: L.1410xI.692xH.855mm
- storage (metal plate): L.1410xI.610mm
- weight: 95kg
- possibility to fit 1 drawer only EG0337 (not included)

+ High weight capacity 700kg



METAL WORKBENCH WOODEN TRAY

EG 0336

Dimensions:

- wooden trays: L.2000xI.740xH.30mm
- framework: L.1900xI.692xH.855mm
- storage (metal plate): L.1900xI.610mm
- weight: 120kg
- possibility to fit 1 drawer only EG0337 (not included)



EG 0337 DRAWER

Accessory of EG 0335/EG 0336/EG 0311/EG 0312



PERFORATED PANEL TOOL RACK 500x900x30mm

EG 0357

Accessory of EG 0335/EG 0336/EG 0311/EG 0312

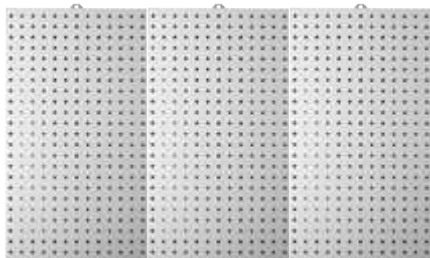

Modular to meet your needs, EG0357 panels have been designed to be assembled together.



Perforation, square 10x10, clearance 38mm



BAG OF 10 DOUBLE HOOKS Ø6mm L.50mm

EG 0344



BAG OF 10 SIMPLE HOOKS Ø6mm L.50mm

EG 0346



BAG OF 10 DOUBLE HOOKS Ø6mm L.100mm

EG 0347



Ø hook: 6mm
Hook length: 50mm
Tip 45°
Squared perforated panel fixing
10x10mm (38mm gap)





BODYWORK 3 TRAY STORAGE TROLLEY

TN

OC 0711

Allows parts which have been uninstalled to be put away and stored such as headlights, headrests, instrument panels, bumpers...



Specifications:

- 3 trays (2 wooden and 1 mesh)
- platform height: 260-810-1390mm
- mesh base
- 4 swiveling wheels, 2 of which have brakes
- dimensions: L.630xW.1110xH.1625mm



3 TRAY ROLLER CABINET

TN

EG 0083



Specifications:

- overall dimensions: 766x415x840mm
- tray dimensions: 760x410x60mm
- 2 fixed casters Ø100mm
- 2 swiveling casters Ø100mm with brakes
- 2.5mm thick EVA foam tray protection
- admissible load per shelf: 30kg
- total admissible load: 90kg



900W INDUSTRIAL BENCH GRINDER Ø200x32x32mm WHEEL+BRUSH

TN

EG 0225

Specifications:

- adjustable protective screen with magnifying lens
- dual extractor vent
- speed: 2950 rpm
- Fixing:
 - 250mm wide centre distance
 - 155mm deep centre distance

Supplied with:

- brush Ø200mm
- grinding wheel grit 60



NOTE

Workshop device see p.111



Releasable jaw system allowing you to make adjustments to the jaw immediately.

Bits available at retail

PARALLEL JAW CLAMPS 150mm QUICK TUBE HOSE APPROACH

TN

OM 4066

Specifications:

- jaw width: 150mm
- jaw height: 20mm
- opening: 180mm
- interchangeable steel jaws
- supplied with revolving base with 3 anchoring points

PARALLEL JAW CLAMPS 205mm QUICK TUBE HOSE APPROACH

OM 4068

Specifications:

- jaw width: 205mm
- jaw height: 22mm
- interchangeable steel jaws
- tube, anvil and horn jaws
- jaw opening: 260mm
- useful height inside the vice: 95mm
- supplied with revolving base with 3 anchoring points (180x225mm)
- power take-off for tube diameter max 75mm



CHOOSE YOUR GAS EXTRACTOR PROPERLY.

Key points to consider.

- vehicle type : LV, LCV, very low vehicle?
- space and set up required in the workshop?

There are many types of extractors:

- **mobile** (pneumatic or electric): the device moves towards the vehicle to proceed to the extraction
- **stationary** (suction unit or reel): the car gets as close as possible to the device

To consider:

You should know that French health insurance recommends suction rates adapted to each vehicle (order of December 9, 2020):





- higher than 400m³/h for cars
- higher than 1000m³/h for trucks



MOBILE VACUUM SOLUTIONS

Ideal for **non-permanent** use and **multiple work areas**. All mobile machines must be operated close to an external opening for smoke extraction.



• PNEUMATICS

SPECIFICATIONS	 MOTORCYCLE - LV 	 LV-LCV-HGV 
Diameter	Ø 75mm	Ø 120mm
Length	5m	6m
Reference	EG 0405	EG 0409



- +** Lightweight, easy to move
- Air supply, limited performance

• ELECTRICS

SPECIFICATIONS	 MOTORCYCLE - LV 	LCV-HGV 
Diameter	Ø 75mm	Ø 150mm
Length	2x1,25m	1m
Output	Dual output	Single output
Reference 230V	AG 0023	AG 0025
Reference 400V	AG 0024	AG 0026



- +** Mobile, universal, no exhaust height constraints
- Workshop space



FIXED VACUUM SOLUTIONS

+ Standardized, small footprint
No exhaust height constraints.

- Dedicated installation space

Wall installation, ideal for single-user.

SPECIFICATIONS	LV			
	Monodescent		Double descent	
Typology				
Diameter	Ø 100mm	Ø 150mm	Ø 100mm	Ø 150mm
Length	5m	5m	2x5m	5m
FAP	-	yes	-	yes
Reference 230V	AG 0019	AG 0057	AG 0021	-
Reference 400V	AG 0020	AG 0058	AG 0022	AG 0059



STATIONARY ELECTRICS SOLUTIONS

The best **quality-practicality-space ratio**.

+ Easy to install

- Few workstations covered



SPECIFICATIONS	MOTORCYCLES		LV				LCV - HGV		
	Ø 75mm		Ø 100mm		Ø 125mm	Ø 150mm	Ø 125mm	Ø 150mm	Ø 150mm
Length	10m	15m	10m	15m	15m	15m	10m	8m	10m
High pressure	Yes		No						
Reference 230V	AG 0001 AG 0003	AG 0005	AG 0007	AG 0009	AG 0013	AG 0016	AG 0011	-	AG 0015
Reference 400V	AG 0002 AG 0004	AG 0006	AG 0008	AG 0010	AG 0014	AG 0018	AG 0012	EG 0424	AG 0017

RAILS SOLUTIONS

+ Multi-workstation

- Footprint

Requires dedicated, **permanent installation**, ideal for **several operators**



SPECIFICATIONS	LV					
	1			2		
NB of carts						
Length	8m	12m	16m	8m	12m	16m
Reference 400V	AG 0042	AG 0043	AG 0044	AG 0045	AG 0046	AG 0047



PNEUMATIC EXHAUST GAS EXTRACTION

PNEUMATIC EXHAUST GAS EXTRACTION 5m Ø75mm

EG 0405

Pneumatic exhaust gas extractor that requires 5 to 8bar Ø10mm compressed air supply.



+ Small footprint



- adjustable height min. 15cm max. 55cm
- inlet Ø130mm
- evacuation hose length 5m Ø75mm, 200°C
- compressed air supply Ø10mm



TE

DUAL EXHAUST SYSTEM GAS EXTRACTOR

EG 0406

Accessory of EG 0405



Up to 200°C
Outlet: Ø90mm
Inlet: Ø52mm



TE

PNEUMATIC EXHAUST GAS EXTRACTION 6m Ø120mm

EG 0409

Connect the extractor to a filtered non lubricated compressed air line

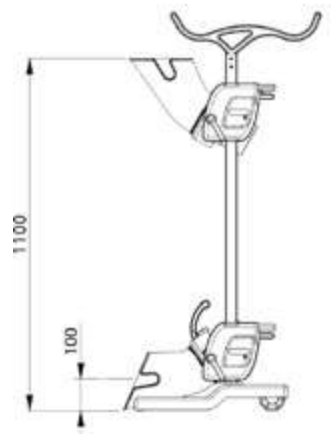
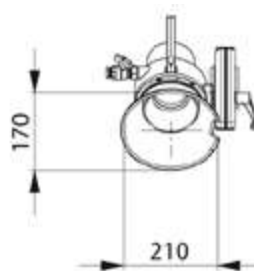

- Specifications:**
- extractor: 790m³/h
 - 6m rubber discharge hose 200°C Ø120mm
 - supply pressure 6bar
 - minimum supply line Ø10mm



TE

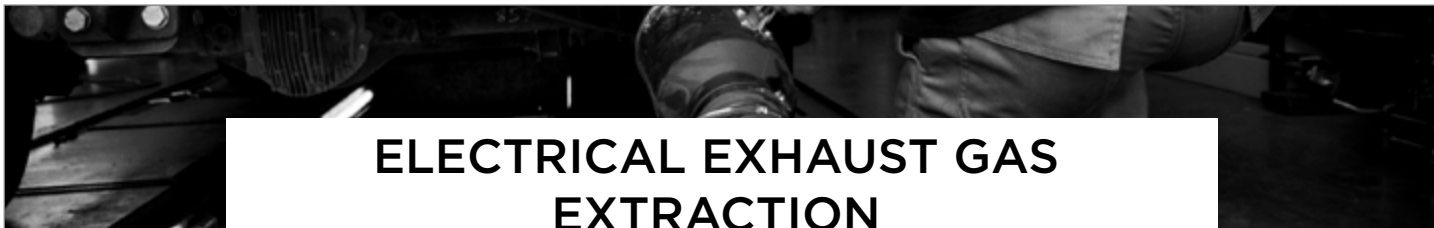

ELECTRICAL EXHAUST GAS EXTRACTION

LV

This extractor is the easiest installation kit to install on a wall or on the front. The equipment allows to work in a healthy environment without inhalation of exhaust gases and in compliance with the safety standards at work.

TE

SINGLE EXTRACTOR GROUP 5m Ø100mm 400V TRIPHASE

AG 0020

Specifications:

- galvanized steel structure
- electric motor, statically and dynamically balanced wheel, delivered with wall bracket and rubber funnel.
- 5m of Ø100mm hose (-40° to +200°) made of high temperature EPDM vulcanized fabric on both sides. Completely anti-crushing structure, smooth inside and maintains flexibility over time thanks to the strong nylon spiral with a very tight pitch. This feature prevents the hose from stretching during pulling and from crushing in high stress situations.
- delivery: Ø 125mm
- power supply: 400V Tri
- motor power: 0,5cv, 0,37KW, 50HZ, 1.0A
- max flow: 450m³/h
- noise level: 66dB
- thermal protection switch
- rubber exhaust nozzle with watertight valve included in the body of the product, anti-intrusion network, clamp for fixing to the exhaust

Many options available, please consult us.

+ Easy to install



SINGLE EXTRACTOR GROUP 5m Ø100mm

AG 0019

Specifications:

- galvanized steel structure
- epoxy paint
- 5m of pipe Ø100mm (-40° to +200°) in fabric vulcanized in EPDM at high temperature on both sides
- delivery: Ø 125mm
- power supply: 230V Mono
- motor power: 0,5cv, 0,35KW, 50HZ, 1.0A
- max flow: 450m³/h
- noise level: 66dB
- thermal protection switch
- exhaust nozzle equipped with an anti-intrusion grid, a manual clamp, a gas suction shutter and an access for the opacimeter probe

Many options available, please consult us.



SA 3223 METER HIGH TEMPERATURE 500°C EXHAUST PIPE Ø100mm

Accessory of EG 0421/EG 0422/EG 0423/SA 3217

SA 3217 METER CRUSH-PROOF 200°C EXHAUST PIPE Ø100mm

Accessory of SA 3222/AG 0007/AG 0008/AG 0009/AG 0010/AG 0019/AG 0020/AG 0021/AG 0022/AG 0048/AG 0049



MUST-HAVE

LV

DOUBLE EXTRACTOR GROUP 2x5m
Ø100mm 400V TRIPHASE

AG 0022

Specifications:

- galvanized steel structure
- electric engine, statically and dynamically balanced wheel, delivered with wall bracket and rubber funnel
- 2x5m of Ø100mm hose (-40° to +200°) made of high temperature EPDM vulcanized fabric on both sides. Completely anti-crushing structure, smooth inside and maintains flexibility over time thanks to the strong nylon spiral with a very tight pitch. This feature prevents the hose from stretching during pulling and from crushing in high stress situations.
- delivery: Ø125mm
- power supply: 400V Tri
- engine power: 1hp, 0,75KW, 50HZ, 2,9A
- max flow: 2x450m³/h
- noise level: 66dB
- thermal protection switch
- rubber exhaust nozzle with watertight valve included in the body of the product, anti-intrusion network, clamp for fixing to the exhaust

Many options available, please consult us.



DOUBLE EXTRACTOR GROUP 2x5m
Ø100mm

AG 0021

Specifications:

- galvanized steel structure
- electric motor, statically and dynamically balanced wheel, delivered with wall bracket and rubber funnel.
- 2x5m of hose Ø100mm (-40° to +200°) in high temperature EPDM vulcanized fabric on both sides. Completely anti-crushing structure, smooth inside and maintains flexibility over time thanks to the strong nylon spiral with a very tight pitch. This feature prevents the hose from stretching during pulling and from crushing in high stress situations.
- delivery: Ø 125mm
- power supply: 230V Mono
- motor power: 1hp, 0,75KW, 50HZ, 2,9A
- max flow: 450m³/h
- noise level: 66dB
- thermal protection switch
- rubber exhaust nozzle with watertight valve included in the body of the product, anti-intrusion network, clamp for fixing to the exhaust

Many options available, please consult us.



+ Easy to install



SA 3217 METER CRUSH-PROOF 200°C EXHAUST PIPE Ø100mm

Spare part of EG 0421/EG 0422/EG 0423
Accessory of SA 3222/AG 0007/AG 0008/AG 0009/AG 0010/AG 0019/AG 0020/AG 0021/AG 0022/AG 0048/AG 0049

SA 3223 METER HIGH TEMPERATURE 500°C EXHAUST PIPE Ø100mm

Accessory of EG 0421/EG 0422/EG 0423/SA 3217



TE

LV

DOUBLE GAS MOBILE VACUUM CLEANER
2x1.25m Ø75mm

AG 0023

Perfect for moving to different work areas for the LV workshops.

Specifications:

- galvanized steel structure
- platform mounted on 4 swivel wheels
- epoxy paint (grey RAL 7040)
- 2x1,25m of pipes Ø75mm (-40° to +200°) in EPDM vulcanized fabric at high temperature on both sides
- delivery: Ø 125mm length 5m
- power supply: 230V Mono
- motor power: 0,5cv, 0.37KW, 50HZ, 1.7A
- max flow: 2X250m³/h
- noise level: 66dB
- on/off switch
- exhaust tips equipped with an anti-intrusion grid, manual clamps, gas suction shutters and access for the opacimeter probe

Many options available, please consult us.



DOUBLE GAS MOBILE VACUUM CLEANER 2x1.25m Ø75mm 400V

AG 0024

Specifications:

- galvanized steel structure
- platform mounted on 4 swivel wheels
- epoxy paint (grey RAL 7040)
- 2x1,25m of pipes Ø75mm (-40° to +200°) in EPDM vulcanized fabric at high temperature on both sides
- delivery: Ø125mm length 5m
- power supply: 400V Tri
- engine power: 0,5rp, 0.37KW, 50HZ, 1.7A
- max flo: 2x250m³/h
- noise level: 66dB
- on/off switch
- exhaust tips equipped with anti-intrusion grid, manual clamps, gas suction shutters and access for the opacimeter probe

Many options available, please consult us.



+ Mobility

SA 3207 METER ANTI-CRUSHING HOSE 200°C GAS ESCAP. Ø75mm

SA 3219 METER CRUSH-PROOF 200°C EXHAUST PIPE Ø150mm



TE

LCV/HGV

+ Adjustable support

Trolley extractor mounted on 4 swivel wheels, adjustable in height and equipped with an articulated arm allowing the placement of the exhaust nozzle on the vehicle without the pipe touching the ground. The equipment allows to work in a healthy environment without inhalation of exhaust gases and in compliance with the safety standards at work.

LCV/HEAVY WEIGHTS MOBILE GAS VACUUM 1m Ø150mm 400V

AG 0026

LCV/HEAVY WEIGHTS MOBILE GAS VACUUM 1m Ø150mm

AG 0025





LV

This mechanical spring reel complete with exhaust blower can be installed on the ceiling or wall, always maintaining the same performance. The equipment allows you to work in a healthy environment without inhalation of exhaust gases and in compliance with work safety standards. Hose: anti-crushing structure, maintains flexibility over time thanks to the robust nylon spiral with a very tight pitch. This feature prevents the hose from stretching during pulling and from collapsing in high stress situations. Its smooth design on the inside guarantees maximum suction efficiency in m3. Directly coupled electric motor, statically and dynamically balanced impeller to limit friction, vibration and reduce energy consumption. Inlet and outlet flanges are sized for optimum suction capacity. Support feet for wall or ceiling mounting are included.



EXHAUST GAS ON ROLLER 10m
Ø100mm 400V

AG 0008



EXHAUST GAS ON ROLLER
10m Ø100mm

AG 0007

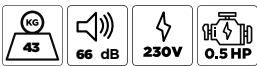

EXHAUST GAS ON ROLLER 15m
Ø100mm 400V

AG 0010



GAS SUCTION ON REEL
15m Ø100mm 230V

AG 0009



EXHAUST GAS ON ROLL
15m Ø125mm

AG 0013

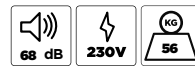

EXHAUST GAS ON ROLL
15m Ø150mm 400V

AG 0018

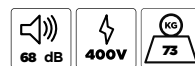

EXHAUST GAS ON ROLL 15m
Ø125mm 400V

AG 0014



EXHAUST GAS ON ROLL
15m Ø150mm

AG 0016

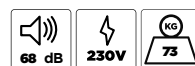

AVANTAGE
Connection of the hose to the reel by an ABS gooseneck, guarantees no deformation, no loss of suction efficiency.





TE

HGV

This mechanical spring reel complete with exhaust blower can be installed on the ceiling or wall, always maintaining the same performance. The equipment allows you to work in a healthy environment without inhalation of exhaust gases and in compliance with work safety standards.

Hose: anti-crushing structure, maintains flexibility over time thanks to the robust nylon spiral with a very tight pitch. This feature prevents the hose from stretching during pulling and from collapsing in high stress situations. Its smooth design on the inside guarantees maximum suction efficiency in m3.

Directly coupled electric motor, statically and dynamically balanced impeller to limit friction, vibration and reduce energy consumption. Inlet and outlet flanges are sized for optimum suction capacity. Support feet for wall or ceiling mounting are included.



EXHAUST GAS ON ROLL HEAVY WEIGHT 10m Ø125mm

AG 0011

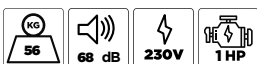

EXHAUST GAS ON ROLL HEAVY WEIGHT 10m Ø125mm 400V

AG 0012

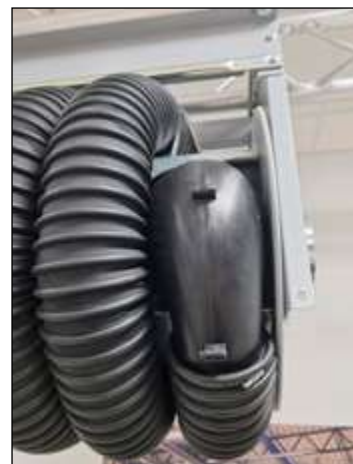
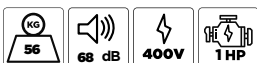

EXHAUST GAS ON ROLL HEAVY WEIGHTS 10m Ø150mm

AG 0015

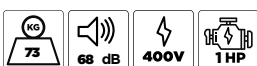

EXHAUST GAS ON ROLL HEAVY WEIGHTS 10m Ø150mm 400V

AG 0017



SA 3217 METER CRUSH-PROOF 200°C EXHAUST PIPE Ø100mm

SA 3219 METER CRUSH-PROOF 200°C EXHAUST PIPE Ø150mm

SA 3223 METER HIGH TEMPERATURE 500°C EXHAUST PIPE Ø100mm

MECHANICAL EXTRACTOR REEL GAS HGV

EG 0424

Specifications :

- cast aluminium fan
- 8m anti-crush rubber hose Ø150mm-200°C
- automatic winder with ratchet stop
- supplied without extraction duct
- discharge: Ø160mm
- 400V three-phase power supply
- motor power: 1.0hp, 0.75KW, 50 HZ, 1.7A
- max flow: +/- 1500m³/h
- noise level +/-70dB
- switch included
- polycarbonate flanges
- weight: 83kg



TE



EXHAUST GAS EXTRACTION • ELECTRICAL EXHAUST GAS EXTRACTION

← SCAN TO SEE OUR ENTIRE RANGE OF **ELECTRICAL EXHAUST GAS EXTRACTION** HERE



AG 0032
AG 0033



AG 0035
AG 0036



AG 0028
AG 0029
AG 0030



AG 0071

AG 0028	OVAL FUNNEL Ø75mm
AG 0030	OVAL FUNNEL Ø125mm
AG 0029	OVAL FUNNEL Ø100mm
AG 0035	FUNNEL CLAMP + CLOSING FLAP Ø100mm
AG 0036	FUNNEL CLAMP + CLOSING FLAP Ø125mm
AG 0032	OVAL FUNNEL/PLIERS Ø100mm
AG 0033	OVAL FUNNEL/PLIERS Ø125mm
AG 0027	Y-DEVIATION ADAPTER 2x5m Ø75mm
AG 0071	FUNNEL CLAMP + CLOSING FLAP Ø150mm



AG 0027



The rail is produced with a modular aluminum extruded profile equipped with an easy to install double rubber lip and extraordinary wear resistance. The rail is equipped with two sliding tracks outside the suction chamber to maintain the sliding elements over time. The lightness combined with the rigid structure of the profile facilitates the installation and guarantees optimal results for an easy extraction of the exhaust gases. The equipment allows to work in a healthy environment without inhalation of exhaust gases and in compliance with occupational safety standards.

RAIL KIT

AG 0042	GAS SUCTION ON RAIL - 1 CART 8M
AG 0043	GAS SUCTION ON RAIL - 1 CART 12M
AG 0044	GAS SUCTION ON RAIL - 1 CART 16M
AG 0045	GAS SUCTION ON RAIL - 2 CARTS 8M
AG 0046	GAS SUCTION ON RAIL - 2 CARTS 12M
AG 0047	GAS SUCTION ON RAIL - 2 CARTS 16M



CEILING MOUNTING BRACKET KIT

AG 0068	CEILING MOUNTING BRACKET KIT FOR 8m RAIL
AG 0069	CEILING MOUNTING BRACKET KIT FOR 12m RAIL
AG 0070	CEILING MOUNTING BRACKET KIT FOR 16m RAIL



3m

Delivery duct (to the outside of the building) horizontal.



7m

Delivery duct (to the outside of the building) vertical.

BACKFLOW

AG 0064	BACKFLOW 3m Ø125mm
AG 0065	BACKFLOW 7m Ø125mm
AG 0066	BACKFLOW 3m Ø160mm
AG 0067	BACKFLOW 7m Ø160mm





TE



**GAS SUCTION UNIT
REGENERATION DPF 5m
Ø150mm 400V**

AG 0058

Specific kit for the LV DPF regeneration.

Specifications:

- galvanized steel structure
- epoxy paint (grey RAL 7040)
- length of pipe: 5m resistant 500° Ø150mm
- delivery: Ø160mm
- power supply: 400V Tri
- engine power: 1,5cv, 1,1KW, 50HZ, 2,4A
- max flow: 1200m³/h
- noise level: 72dB
- thermal protection switch

Many options available, please consult us.

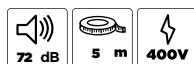

+ High temperature

**GAS SUCTION UNIT
REGENERATION DPF 5m
Ø150mm 230V**

AG 0057

Specific kit for the LV DPF regeneration.

Specifications:

- galvanized steel structure
- epoxy paint (grey RAL 7040)
- length of pipe: 5m resistant 500° Ø 150mm
- delivery: Ø 160mm
- power supply: 230V Mono
- motor power: 1,5cv, 1,1KW, 50HZ, 4,2A
- max flow: 1200m³/h
- noise level: 72dB
- thermal protection switch

Many options available, please consult us.

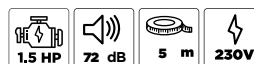

**GAS VACUUM UNIT REGENERATION
DOUBLE FUNNEL DPF 5m Ø150mm
400V**

AG 0059



+ High temperature

TE

Specifications:

- galvanized steel structure
- epoxy paint (grey RAL 7040)
- length of pipe: 5m resistant 500° Ø 150mm
- carriage + support with 700° resistant end caps
- delivery: Ø 160mm
- power supply: 230V Mono
- motor power: 1,5cv, 1,1KW, 50HZ, 4,2A
- max flow: 1200m³/h
- noise level: 72dB
- thermal protection switch

Many options available, please consult us.

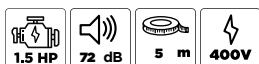

SPILL CONTAINMENT

Dangerous waste in the workshop

The law requires all workshops to collect and separate their dangerous/ polluting waste.

There are different types in mechanical workshops:

- cooling and brake fluids
- used oil change
- oil and fuel filters

- soiled materials and packaging (e.g. rags, cans)
- aerosols
- batteries
- paints
- glues and sealants

It is necessary to have adapted trays.



Our systems can go up to the platform



The platforms can connect to each other to create a wide storage area.

The addition of a ramp will provide easy access.

DIFFERENTS TYPES DE TRAYS

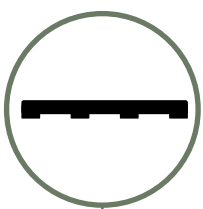

Platform: set on the ground, low profile for space saving



Spill plate to be used on workbench.

From the smallest size to the pallet size.

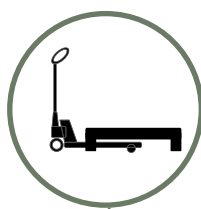

Spill containment tray: location for forks, for carrying with a forklift



The waterproof spill tray ensures no leakage and no pollution of the ground and/or water.

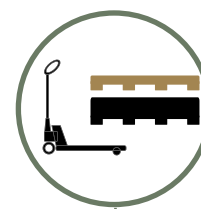









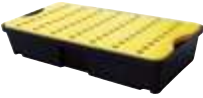

















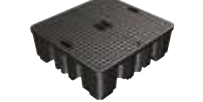

Pallet spill containment tray: the pallet (1200x800) is directly placed on the tray



Pallet spill containment tray, to save time and handling.



TRAYS	REF	Capacity (L)	Storage capacity (Kg)	Length (mm)	Width (mm)	Height (mm)	Tray weight	Drum(s)/ Cubitainer(s)	Handling
 caillebotis amovible	HU 0210	10	50	400	300	155	2 kg	-	
	HU 0220	20	50	600	405	155	3 kg	-	
	HU 0230	30	50	800	400	155	4.5 kg	-	
	HU 0235	60	200	1000	600	175	9 kg	-	
	HU 0265	100	200	1200	800	175	14 kg	-	
	HU 0120	110	1.350	1600	800	150	24.5 kg		
	HU 0240	230	2700	1600	1600	150	45 kg		
	HU 0251	250	650	1310	910	380	16 kg		
	HU 0250	250	650	1300	750	440	20.5 kg		
	HU 0450	480	1250	1380	1290	480	41 kg		
	HU 0255	1100	2000	1380	1290	480	95 kg	 ou 	
	HU 0260	1100	3000	2450	1450	575	199 kg		

PLATFORM RAMP TN

HU 0121

For easy loading





DRUM SUPPORT 220l TN

HU 0440





FUNNEL FOR DRUMS 200L TN

HU 2016





DRUM GRIP 350kg TN

OH 0009







STORAGE SPILL CONTAINMENT

← SCAN TO SEE OUR ENTIRE RANGE OF STORAGE SPILL CONTAINMENT HERE

TN

2 SPILL STORAGE SET WITH DRUM 250L

HU 0290

+ Safe storage of dangerous products.



- dimensions: L.995xW.1565xH.2100mm
- storage of chemical products and hazardous waste
- opening on 2 sides

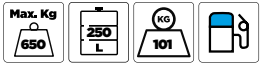

MORE

Extract from article 10 of the decree of February 2, 1998 (France):

I. Any liquid that could pollute the groundwater or soil must be stored within a bund wall with a retention capacity of at least the larger of the following two volumes:

- 100% of the capacity of the largest storage tank,
- 50% of the total capacity of all the storage tanks combined,

(...)

For the storage of containers with a unit capacity equal to or less than 250 liters, the retention capacity must be at least:

- In the case of flammable liquids, with the exception of lubricants, 50% of the total capacity of the barrels,
- In other cases, 20% of the total capacity of the barrels, (...)

II. The bund wall must be leak-proof for the substances it may have to contain and resistant to physical and chemical attack by these substances.

This must also be the case for its shut-off device, which must be kept closed. It must be possible to test the leak proofing of the associated tank(s) at any time (...)

Tanks or recipients containing i

SOURCE: Ministry of Ecology, Energy, Sustainable Development and the Sea (AIDA, INERIS)

GENERAL TOOLS



LIGHTING

P.68



FLUID DISTRIBUTION & GREASING

P.78



CLEANING

P.83



REELS

P.89



PNEUMATIC TOOLS

P.94

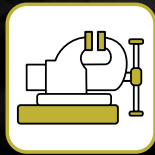

WORKSHOP DEVICE

P.111



DRILLING & THREADING

P.124



LIFTING

P.128



PRESS SHOP

P.151

CHOOSE YOUR INSPECTION LAMP PROPERLY.

Why ?

Eye strain is usually not considered during work, but its impact can be quickly disabling.

Excessive light intensity may cause annoyance (reflection, dazzling, straining).

A race towards intensity? Yes, but not only.

Your choice should also be influenced by:

- Environment of the intervention (indoor/ outdoor, passenger cabin, engine compartment...)
- Size
- Frequency of use
- Shock resistance



EXPERT ADVICE

Choose a variable intensity light (autonomy management, work comfort).

THERE ARE 4 MAJOR LAMP CATEGORIES



HEADLAMP

- + Hands-free lighting, hard-to-reach areas, perfect for cabin operations
- Uncomfortable headband when wearing it a long time



PENLIGHT

- + Fast inspection, always in the pocket
- Low intensity



INSPECTION LAMPS

- + Versatility, strong, autonomy, perfect for an extended use
- Space saving



RAMP

- + Hands-free lighting, wide range of lighting, telescopic, optimum visual comfort, perfect for cabin interventions
- Space saving



SCAN TO SEE OUR ENTIRE RANGE OF LIGHTING →



KELVIN

It is the color temperature scale, which describes the way certain colors appear to us visually. We refer to warm or cool white depending on the number of Kelvin. Lamps between 5000 and 7000K are those that are close to daylight.

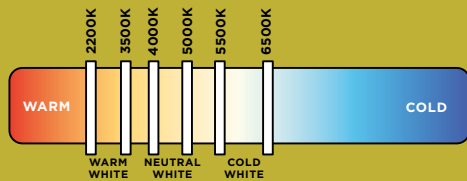

WHAT IS "LUMEN"?

It is the unit of luminous flow measurement, meaning the power of your lighting. One Watt is equivalent to +/- 80 Lumens (depending on the type of LED used).

PROTECTION RATINGS



IP : protection rating against liquids and dust.
 1st number: from 0 to 6 indicates protection against solid bodies
 2nd number: from 0 to 8 indicates protection against liquids
 The higher the number, the more the product is liquid-tight and/or dust-tight.



IK : protection rating against shocks and impacts. This number goes from 01 to 10.
 The higher the index, the more resistant the product is.
 Going from 06 to 08 means a product 5x more resistant.

COMPARATIVE TABLE

		LUMEN MAX	IK	6H	3H	VARIATOR	IP	HEAD-LIGHTING	ROTATION	FIXING	THE ADVANTAGES
PENLIGHT	OE 0395	250lm	IK07	3h30 10h (head)	4h	no	IP54	yes (70lm)	-	magnet + pocket clip	Compact
	OE 0396	250lm	IK07	3h30 10h (head)	4h	no	IP54	yes (70lm)	-	magnet + pocket clip	UV light
	OE 0129	200lm	IK07	1h30 to 4h	1h30	yes	IP20	yes (120lm)	360°	magnet + pocket clip	Pocket size to always have it on hand
HEADLAMP	OE 0057	350lm	-	2h30 to 8h	2h30	yes	-	yes (60lm)	-	ruber band	Wide light angle
INSPECTION LAMPS	OE 0145BL	600lm	-	2h to 10h	4h	yes	-	no	360°	magnet + hook	Economical
	OE 0143 OE 0143R	600lm	IK07	2h to 16h	4h	yes	IP54	yes (90lm)	360°	magnet + hook	Ultra thin
	OE 0159	1000lm	IK07	3h to 15h	2h	yes	IP65	yes	270°	magnet + plier	Wireless speaker Powerful pliers
	OE 0147	300lm	IK08	3h-6h 6h (head)	3h	yes	IP65	yes (100lm)	270°	magnet + hook	Induction charging
	OE 0146	600lm	IK08	2h30-10h 10h (head)	2h30	yes	IP65	yes (100lm)	270°	magnet + hook	Induction charging
RAMP	OE 0178	1000lm	-	3h to 10h	4h	yes	IP65	-	360°	hooks anti scratch	180° light diffusion





HEADLAMPS

MUST-HAVE

TN

DUAL LIGHT FLEXIBLE HEADLAMP

OE 0057

The stretchy silicone headband fits all head sizes and provides comfort during use.

Powerful lamp with 5 lighting modes, it illuminates up to 230°.

Its contactless sensor allows a "hands-free" use.

Multiple uses.

350 LM



60 LM



Hands-free sensor

2 MODES
100%/40%



Stretch and silicone headband



3 MODES
100%/40%/Flash



BENEFIT

Practical: with its motion sensor, it turns on and off without hands!

Available in pack of 12 (delivered on display) to 19^{eHT} unit

45 m

230°





INSPECTION LAMPS

MINI RECHARGEABLE INSPECTION LAMP 3W COB+1SMD

TN

OE 0395

+ Multiple lighting Head and UV facade

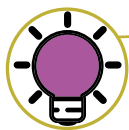

Pocket hook holder



UV MINI RECHARGEABLE INSPECTION LAMP

TN

OE 0396

Pocket hook holder



360° IK07 MINI LAMP

TN

OE 0129

Compact lamp.
Stainless steel pen clip on the back of the case.

+ Great versatility, magnetized clips



Pocket hook holder





ULTRATHIN CORDLESS RECHARGEABLE LAMP WITH VARIABLE INTENSITY

OE 0145BL

B.LINE
BUDGET SOLUTION

+ Economical

Hand lamp equipped with a dimmer.
Rechargeable via USB cable provided.

ADVANTAGE
Choose the light intensity according to your needs.





TN

● ULTRATHIN CORDLESS RECHARGEABLE LAMP WITH VARIABLE INTENSITY 7W IK07

OE 0143

● ULTRATHIN CORDLESS RECHARGEABLE LAMP WITH VARIABLE INTENSITY RED

OE 0143R



Lamp equipped with a dimmer, allowing an optimal intensity adjustment in all situations. The headlight can be used alone or simultaneously with the front lighting thanks to the separate switch. Impact-resistant ABS body with rubber coating for perfect grip.



+ Precise light intensity





RECHARGEABLE WIRELESS SPEAKER PORTABLE LIGHT IK07

OE 0159

Thanks to this portable music player and its integrated speaker, combine business with pleasure!
By connecting it to your smartphone you can listen to your music while working.

This portable light has 2 modes of fixation: either via the magnetic part or thanks to its clip.
In addition to its powerful lighting, the integrated speaker will broadcast your favorite music for hours.

+ Integrated wireless speaker



ADVANTAGE

The most complete : light intensity variation from 10 to 100%, multi-fold fixation and musical atmosphere as a bonus

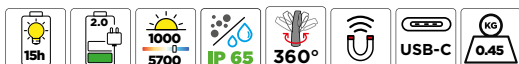



RECHARGEABLE PORTABLE LIGHT IK08

OE 0147

Compact, it can be easily stored in a pocket, built on a magnetic articulated base, as well as 2 magnets on the back and a hook to release the hands of the technician to be fixed conveniently.

+ Induction charging supported

AVANTAGE

Say goodbye to the charging cable.



2 WARRANTY

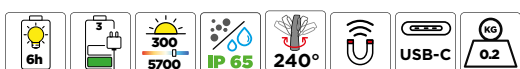

RECHARGEABLE PORTABLE LIGHT IK08

OE 0146

+ Induction charging supported

AVANTAGE

Say goodbye to the charging cable.



2 WARRANTY

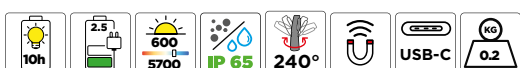

SINGLE INDUCTION CHARGING BASE

OE 0137

Spare part of OE 0147/OE 0146

Specifications:

- dimensions: 105x150mm
- input 5V/1A
- USB output 5V/5W
- equipped with a power indicator
- delivered with its USB/C charging cable



DUAL INDUCTION CHARGING BASE

OE 0138

Spare part of OE 0147/OE 0146

Specifications:

- dimensions: 105x200mm
- input 5V/2A
- USB output 5V/1A
- equipped with a power indicator
- delivered with its USB/C charging cable



2 WARRANTY



PACKS HANDLAMPS + CHARGERS

TN

+ Choose your pack!



PACK LIGHT OE 0146
+ SINGLE INDUCTION
CHARGER

OE 9494



PACK LIGHT OE
0147+ SINGLE
INDUCTION
CHARGER

OE 9595



PACK LIGHTS OE 0146X2+ DUAL
INDUCTION CHARGER

OE 9696



PACK LIGHTS OE 0147X2+
DUAL INDUCTION CHARGER

OE 9797



PACK LIGHTS OE 0146+OE 0147+ DUAL
INDUCTION CHARGER

OE 9898





RAMPS

RECHARGEABLE ALUMINUM RAMP 32 LED IK07

TN

OE 0178

The light ramp is simple and fast to set up to work hands-free, under the car's hood or inside the car.



ADVANTAGE
Allows an intervention on large areas, hands free.

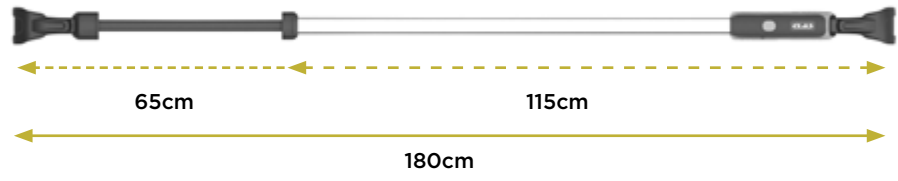
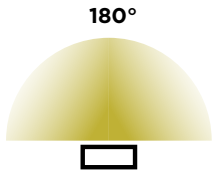

-
-
-
-
-
-





TRAY COLLECTORS

HGV AXLE DRAIN PAN

TN

HU 0035

This pan has been designed to collect fluids from HGV axles. When removing a wheel shaft on an industrial vehicle, the oil in the reducers flows onto the rim. This pan has been designed to collect this oil.



- to be placed directly onto the wheel to collect the oil
- suitable for several rim sizes
- with pouring spout

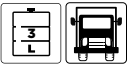

MUST-HAVE

TN

FLUID COLLECTION CONTAINER

HU 0031



Specifications:

- dimensions: 780x495x120mm
- max. wheelbase: 920mm
- equipped with 4 swiveling wheels
- 2 carry handles
- pouring spout



METALLIC DRAIN PAN FOR FLUIDS H.80mm

TN

HU 0950



Specifications:

- width: 1300mm wide and 900mm straightest
- length: 1250mm
- height: 80mm
- drain tap - drain valve
- vertical storage feet





FLUID DISTRIBUTION

DIGITAL VOLUMETRIC GUN 1/2" OIL/ ANTIFREEZE

TN

HU 0617

This gun ensures simple, rapid and measured distribution. For oil and anti-freeze.



Specifications:

- variable flow speed: 0-35l/min
- max. pressure: 100bar
- precision: ±0,5%
- swivel connector 1/2"
- automatic anti-drip hose bit L.180mm
- locking handle clip
- 3V 1400mAh battery
- autonomous operation: 8 years / 500,000L



FLUID EXTRACTOR/DISPENSER

TN

HU 0631

For motor oil, cooling fluid, brake fluid... Do not use with flammable liquids



Specifications:

- probe length: 1600mmx3
- Ø6-8-10mm
- manual pump
- pressure/vacuum inverter



PNEUMATIC OIL DISTRIBUTOR 24L

TN

HU 0620

NOTE

Oil recuperator p. 232



Specifications:

- supply for tank discharge: 0.5bar
- level indicator
- trigger with holding in discharge position
- fixed filling funnel, with strainer



DRUM TROLLEY 180-220kg

TN

HU 0716



MOBILE OIL DISTRIBUTION BARREL 180-220kg

HU 0613



HU 0716



HU 0619N



HU 0617





MANUAL PRIMING PUMP WITH TAPPET

HU 0657BL



Manual priming pump, suitable to transfer several kind of liquids (non-corrosive) from a standard 200l drum.



TN

3:1 PNEUMATIC OIL PUMP+FLEXIBLE BARRELS 180-220kg

HU 0639N

Specifications:

- maximum flow rate: 15l/min
- ratio: 3:1 for low to medium viscosity oil (SAE 15/130)
- 4m hose included
- supply pressure: 6-8bar

PNEUMATIC OIL 5:1 PUMP+SUCTION TUBE FOR 180-220kg DRUMS

HU 0619N

Specifications:

- maximum flow rate: 12l/min
- ratio: 5:1 for medium to high viscosity oil (SAE 15/240)
- 4m hose included
- supply pressure: 6-8bar



Compatible with barrels from 180 to 220kg in mobile solution thanks to its 845mm plunger equipped with a strainer.



TN

METAL TRANSFER PUMP

HU 0014BL



Pump with a lateral lever, ideal for transferring various types of liquid (non corrosive) such as oil, diesel or kerosene from a standard 200l barrel.



TN

TRANSFER PUMP FOR DRUMS 200L

HU 0011



Side lever barrel pump suitable for pumping various (non corrosive) liquids such as oil, diesel, anti freeze and washer fluid from standard 200l drums.

Specifications:

- viton® seals
- 3 flow positions: 310/330/350 mL by pumping
- extending tube to reach the bottom of drums
- 2 in 1 fixing: Ø59mm thread 200-Ø63 thread 400



TN

ROTARY PUMP SUITABLE FOR AdBlue®

HU 0013



Special pump to transfer AdBlue. Also suitable for other fluids like water, diesel, oil...



Specifications:

- supplied with a 2" bsp fitting
- 0,3 litre per crank turn
- inlet tube 1000mm
- fixing Ø59mm thread 200



TN



OIL CAN 500ml

HU 0511



TN

2l GRADUATED PITCHER

HU 0002

5l GRADUATED PITCHER

HU 0005

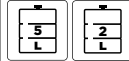

TN

FUEL TRANSFER PUMP

HU 0629



Supplied with 130cm transfer hoses



TN

0.2l SYRINGE

HU 0637



Graduation



TN

1.5l SYRINGE

HU 0638



Graduation



TN

FLEXIBLE SPOUT FUNNEL Ø145mm

HU 0513BL

Funnel with spout and filter.

B.LINE
BUDGET SOLUTION



Specifications:

- funnel Ø145mm with filter (L.153mm)
- flexible spout L.260mm





GREASING

GREASING GUN 500ml

TN

HU 0512

This high pressure grease gun works at 550bar and has an improved plunger for complete grease removal for both cartridge and bulk grease loading.



For 500ml cartridge, supplied with flexible.



PNEUMATIC GREASING GUN 450ml

TN

OP 0521



Specifications:

- nozzle length: 170mm
- capacity: 450ml
- operating pressure: 6.2bar
- weight: 1.8kg



HOSE GREASING REEL

TN

Ø8mm 20m 350bar

HU 1818



Specifications

- epoxy powder coated steel brackets
- stop device every 50cm
- reinforced hose SAE 100R2AT
- hose Øint. 8mm
- length 20m
- max pressure 350bar
- connector 1/4"





VACUUMS

TN



+ 2 engines
air & water

DRY AND WET VACUUM CLEANER 2x1000W

EG 0040

Specifications:

- stainless steel tank mounted on a 4-wheel dolly
- 2 motors of 1000W each
- 80l tank Ø420mm
- drain on 500mm tank
- pressure: 21kPa
- air flow: 108l/s
- sound level: 73dB
- power supply 230V 4m cable
- power: 2000W
- dimension (lengthxdepthxheight): 540x595x940mm

Included accessories:

- SA0442: thin tip with connector Ø42mm
- SA0443: Ø60mm brush with connector Ø42mm
- Ø42mm handle with accessory connector Ø37mm
- SA0440: 2200mm flexible hose Ø42mm
- SA0444: Ø37mm scraper
- SA0445: Ø37mm brush length 400mm
- SA0441: cloth filter



SA 0446	SPIRAL 4000mm Ø42mm	29 €VAT Excl.
SA 0045	600mm FRONT BRUSH ASSEMBLY WITH HOSE	82 €VAT Excl.



DRY AND WET VACUUM CLEANER 2x1000W + SPIRAL 4m

EG 1040



DRY AND WET VACUUM CLEANER 2x1000W+FRONT BRUSH ASSEMBLY 600mm

EG 0045

Included accessories:

- SA0442: thin tip with connector Ø42mm
- SA0443: Ø60mm brush with connector Ø42mm
- Ø42mm handle with accessory connector Ø37mm
- SA0440: 2200mm flexible hose Ø42mm
- SA0444: Ø37mm scraper
- SA0445: Ø37mm brush length 400mm
- SA0441: cloth filter
- SA0045: front brush assembly 600mm with hose



PNEUMATIC PORTABLE VACUUM

EG 0407

Lets you vacuum in hard-to-reach places (plug wells...)



Supplied with 3 bits + 1 extender

TN



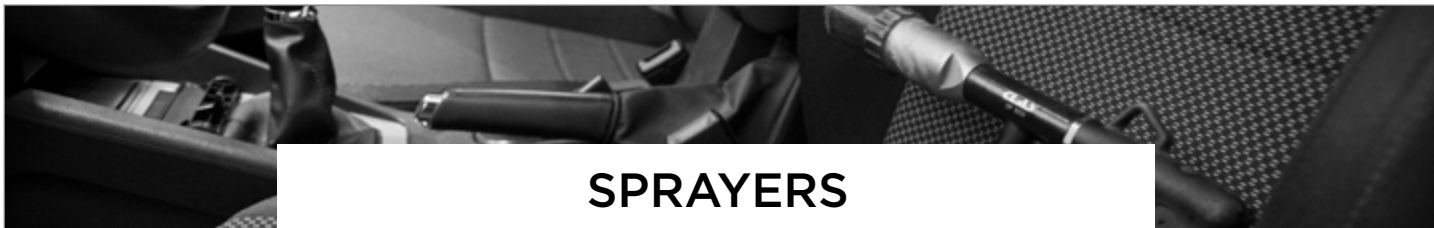

SPRAYERS

1.5L RED PRESSURE SPRAYER

OC 1501 8,50 €VAT Excl.



- adjustable nozzle



1.5L BLUE PRESSURE SPRAYER

OC 1502 8,50 €VAT Excl.



- adjustable nozzle



TN

PRO SPRAY GUN

OP 0044 74 €VAT Excl.



Specifications:

- 2 adjustable jets and air flow
- nozzle L.300mm Ø2mm
- connector 1/4"
- service pressure: 2 to 8bar



TN

1.7L PRESSURE SPRAYER BRAKE CLEANER

OC 1510 34 €VAT Excl.

Wider base for more stability when filling.

+ Designed for use with brake cleaner



Specifications:

- Viton® seals
- adjustable nozzle
- capacity: 1.5l+10%
- graduation: 0.5l-16oz
- graduation dilution 5 and 10
- side relief valve
- expanded Base



TN

HIGH PRESSURE RECHARGEABLE SPRAY 650ml

EG 1532 79 €VAT Excl.



Specifications :

- trigger release
- aluminum bottle
- 2-in-1 nozzle (mist and jet)
- Schrader®-type pressurization valve
- 12-bar safety valve



TN

CO 1530	5L CONTAINER OF BRAKES CLEANER	46 €VAT Excl.
---------	--------------------------------	---------------

CO 1018	DEGREASING/CLEANING PRODUCT FOR WASHERS 25L	179 €VAT Excl.
---------	---	----------------



CLEANING GUNS

CLEANING GUN

TN

OP 0022 169 €VAT Excl.



Connector supplied

Cleans bodywork, wheels, dashboard, air vents, engine... and door jambs.
Ultra-low consumption thanks to special vortex technology.
Its vortex propulsion system gives it unbeatable results.



CLEANING SOLUTION

TN

SA 6022 42 €VAT Excl.



2l can.
To mix with water (25%).



CLEANING GUN EVOLUTION

TN

OP 0024 169 €VAT Excl.

Use it on seats, air vents, gear shift, wheels, ventilation, registration plates, wheel rims...
Easy to carry and non-cumbersome



Encapsulated ball bearing. No rubbing between the bearing and the cone

- reduced wear and tear
- increased efficiency
- improved power
- very fine vaporisation of the liquid for powerful cleaning
- can be used with a solution of water + cleaning solution or water alone

Specifications:

- nozzle rotating speed 4000-8000rpm
- operating pressure 5 to 8 bars
- consumption 180L/min
- bowl capacity 1L
- connector supplied





ULTRASONIC CLEANERS

TN



ULTRASONIC CLEANER 3I 100W 40KHZ

OE 7200

Specifications:

- heating temperature adjustable from 0 to 80°C
- timer from 1 to 99 minutes
- ultrasonic power: 100W
- heating power: 100W
- digital display
- tank drain valve
- tank capacity: 3L
- tray dimensions: 240x140x100mm
- external dimensions: 270x240x170mm



ULTRASONIC CLEANER 9I 200W 40KHZ

OE 7201

Specifications:

- heating temperature adjustable from 0 to 80°C
- timer from 1 to 99 minutes
- power: 200W
- digital display
- tank drain valve
- tank capacity: 9l
- external dimensions: 330x310x270mm
- tray dimensions: 300x240x150mm



SA 7070 TUB OF ULTRASOUND CLEANING SOLUTION CONCENTRATE 25% 2L

+ 2 liters of solution = 8 liters of product





TN

HAND CLEANSING WIPES (80 PCS)

CO 0502

Hand cleansing wipes clean without water, soap or rinsing, for occasional or recurrent hand care with maximum effectiveness for all your professional activities.
 Cleans, degreases, removes paint and glue, protects.
 Can be used on all your alloy and plastic tools.
 With Aloe Vera.



+ Double-sided: soft & rough
 Hypoallergenic and paraben-free



Specifications:

- Double-sided: soft & rough
- Removes dirt, grease and grime
- Hypoallergenic and paraben-free
- Protects the epidermis: enriched with Aloe vera
- Citrus fragrance



CAR CLEANING WIPES (80PCS)

CO 0503

Multi-purpose wipes clean without water or rinsing, for occasional or recurrent maintenance of all vehicles, inside and out.
 The wipes allow you to care for, clean and restore the shine of new in a single operation.
 Cleans, protects, antistatic, water-repellent and high-gloss.
 Can be used on all surfaces such as bodywork, wheels, paintwork, tree resin, interior and exterior plastics, fairings, fairing bubbles, windows, windscreens, optics, chrome, leather and skai upholstery...
 Silicone-free. Compatible with matt bodywork.



+ Cleans, protects, antistatic, water-repellent, high-gloss



Specifications:

- cleanses
- protects
- antistatic
- water-repellent
- high gloss
- biodegradable



CAR WASH SET (7PCS)

EG 0011BL

This composition is ideal for cleaning not only rims, but also the interior of the passenger compartment.



Contents:

- 4 soft-bristle brushes: 10-14-16-18mm
- 3 stiff brushes
- 2 flat brushes: 45-120mm
- 1 round-head brush: 85mm





CLEANING

← SCAN TO SEE OUR ENTIRE RANGE OF **CLEANING** HERE

EXPRESS PAINT REMOVER SPRAY 500ml

CO 1027

Allows paint, varnish and ink pickling on every body repair painted element.
Remove burned and imbedded seals (cylinder head, gearbox, water pump, etc).

It allows you to achieve excellent results with no effort required.
Its active formula breaks down problems quickly. This product is suitable for use on solvent-resistant mounts.

Applications: Acrylic, Glycerol, Alkyd, Pliolite...

Also available in box of 12



TN

+ Active formula: quick and efficient



BODY REPAIR DEGREASING/CLEANING SPRAY 500ml

CO 1029

Allows you to degrease and clean bodywork parts before painting or adhesion.
Eliminates residues of glue, grease, oil, silicone.

Also available in box of 12



TN

+ Degreases and removes silicone Antistatic



CABIN PURIFIERS		
CO 1074	CAR CABIN PURIFIER 400ml LEMON	
CO 1075	CAR CABIN PURIFIER 400ml MUSK	
CO 1076	CAR CABIN PURIFIER 400ml MINT	
CO 6216	CABIN PURIFIER 400ml LAVENDER	
CO 6217	CABIN PURIFIER 400ml FOAMING	
CO 6218	CABIN PURIFIER 400ml PINE	
CO 6220	CABIN PURIFIER 400ml VANILLA	

Also available in box of 12



WIRE BRUSH

EG 0056

Handy steel wire metallic brush ideal for a multitude of uses.

- carbon steel wire
- soft grip handle



TN



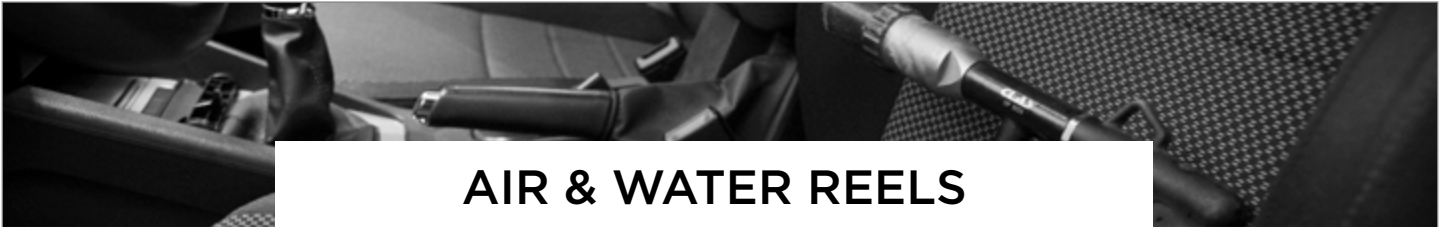

AIR & WATER REELS

AIR REEL Ø8mm 10m

TN

OP 0083BL

Winding guidance

B.LINE
BUDGET SOLUTION



NEW

Specifications:

- high-quality PU tubing
- resistant PP housing
- length 10+1.5m
- Øint. 8mm
- Øext. 12mm
- 1/4" connection
- 180° swivel wall bracket
- high-strength spring tension
- 10bar pressure
- deactivatable shut-off device



10M



AIR REEL Ø8mm 16m

TN

OP 1115

- automatic spacing/scanning cable guide
- stop device every 50cm (can be deactivated)
- dust-tight bearing
- pipe: Øint. 8mm
- connector: 1/4"
- swiveling wall support 180°
- operating pressure: 12bar
- max. pressure: 30bar

+ Automatic cable spacing when rolled up



AIR REEL Ø10mm 16m

OP 1117

Specifications:

- automatic spacing/scanning cable guide
- stop device every 50cm (can be deactivated)
- dust-tight bearing
- pipe: Øint. 10mm
- connector: 1/4"
- swiveling wall support 180°
- operating pressure: 12bar
- max. pressure: 30bar

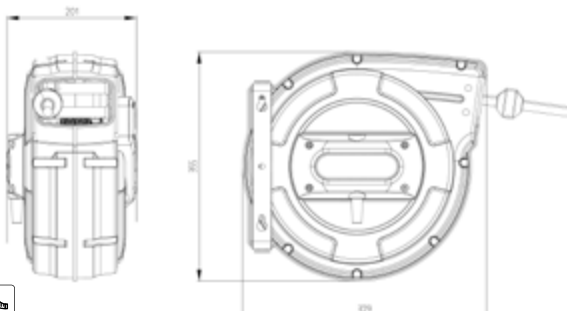

16M





MUST-HAVE

TN

AIR REEL Ø10mm 16m

OP 1017



+ ABS Carter

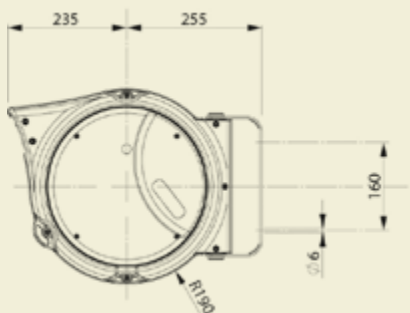

- Specifications:**
- stop device every 50cm
 - hose Øint. 10mm
 - connector 3/8"
 - adjustable wall support 180°
 - max. pressure 15bar
 - tension by high
 - ABS housing

Option: 4 other colors available



16M



HGV AIR REEL Ø13mm 20m

TN

OP 1628

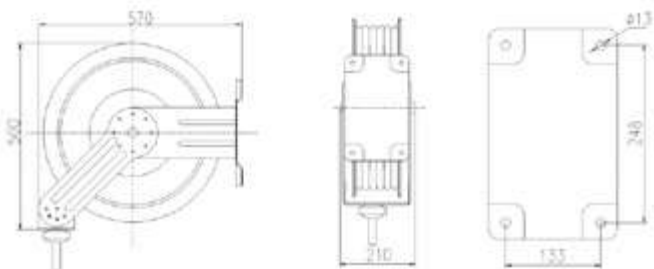

- Specifications:**
- epoxy powder coated steel brackets
 - automatic hose stopping system
 - hose Øint. 13mm
 - max. pressure: 20bar
 - connector 1/2"



20M



HIGH PRESSURE AIR/WATER REEL Ø10mm 20m 280bar

TN

OP 1126

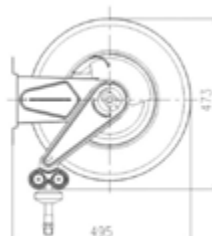
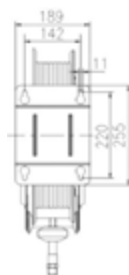

- Specifications:**
- epoxy powder coated steel brackets
 - automatic hose stopping system
 - reinforced hose SAE 100R1AT
 - hose Øint. 10mm
 - max pressure 200bar
 - hot water max 100°C
 - connector 3/8"



20M





OIL & GREASE REELS

OIL REEL Ø10mm 15m 153bar

TN

HU 1316

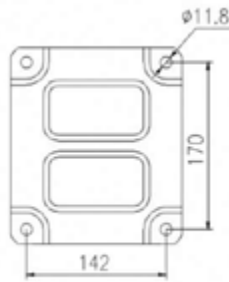
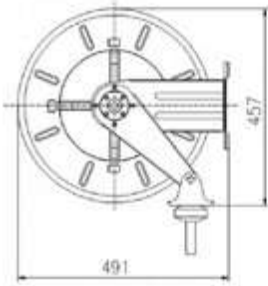

Specificques:

- epoxy powder coated steel brackets
- automatic hose stopping system
- reinforced hose SAE 100R2AT
- hose Øint. 10mm
- length 15m, 150°C
- max pressure 153bar
- connector 3/8"



15M



GREASE HOSE REEL Ø8mm 20m 350bar

TN

HU 1818

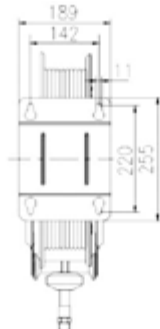
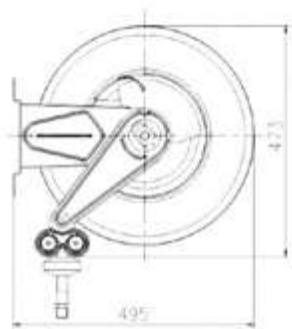

Specifications

- epoxy powder coated steel brackets
- stop device every 50cm
- reinforced hose SAE 100R2AT
- hose Øint. 8mm
- length 20m
- max pressure 350bar
- connector 1/4"



20M





CABLE REELS

TN

WORKSHOP CABLE REEL 3x1.5mm² 20m

OE 0052

+ Integrated circuit breaker



Specifications:

- dimensions: 365mm x 310mm x 120mm
- diameter: 310 mm
- ABS drum
- maximum strength: 2300W (unrolled cable) 1000W (unrolled cable)
- IP rating: IP44
- thermal circuit breaker
- 3 conductors 1.5mm²
- cable HO7 RN-F-20m
- waterproof plug



20M **2** WARRANTY

ELECTRICAL REEL 3x2.5mm² 20m

OE 0423

+ Automatic cable spacing when rolled up

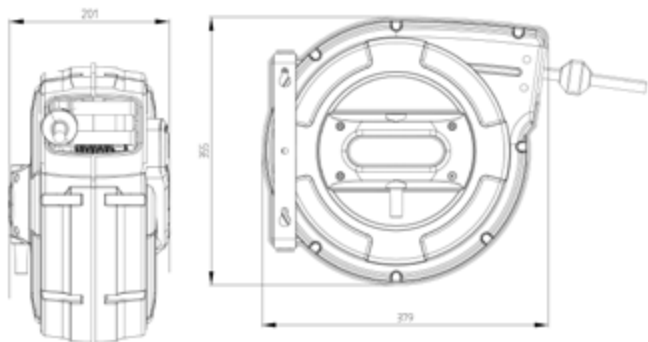

Specifications:

- max. capacity: 3200W
- automatic spacing/scanning cable guide
- stop device every 50cm (can be deactivated)
- wall support 180°
- LED indicating the presence of voltage
- overheating and overloading protection
- utilization temperature -5°/+56°



20M **2** WARRANTY





SIGNPOSTING REEL 20m

EG 0017



- To signal and define a pit or a dangerous area. Reduces the risk of accidents.
- equipped with a hook to facilitate the delimitation
 - anti-UV band
 - band width: 40mm
 - 180° wall support
 - stop device every 50cm



20M



YELLOW AND BLACK SIGNPOST
Ø40mm

EG 0014N



TN

- Specifications:**
- 2 rings with chain/strap connection
 - post material: black and yellow solution-dyed plastic
 - base material: solid rubber
 - height: 90cm



PLASTIC SIGNALING
CHAIN YELLOW/BLACK
25m

EG 0013



TN

Ø links: 6mm

25M



MARKING/WORK AREA
SIGNALING PACK

EG 0012



EG 0015



EG 0014-1

EG 0014-2

EG 0013

- Contents:**
- EG0013: yellow/black 25m plastic signaling chain
 - EG0014-1 (x6): yellow and black signpost Ø40mm
 - EG0014-2 (x6): base for signpost
 - EG0015: signage banner "work zone boundary" 100x20cm



Compatible with authorizations:
B1L, B1VL, B1TL, B2L, B2VL,
B2TL, BCL, BEL, BRL, B1XL,
B2XL.





AIR CONNECTORS

MORE

- 1 - first translatory movement reward: immediate decompression.
- 2 - second translatory movement forward: immediate disconnection.

CLAS connections comply with the international safety standards ISO 4414 and DIN EN 983. The cylindrical monoblock construction in shockproof composite materials, associated with a metallic insert, allows to ensure longevity and reliability. Connections and disconnections are made immediately and effortlessly. The mechanism of waterproofness associated with tips, eliminates any leaks in coupled or uncoupled position. Corrosion protection
Tip in treated steel
Respect of dimensions and tolerances
Pre-fl oating of male threads

The CLAS touch:

- anti-corrosion protection
- hardened steel end cap
- compliance with dimensions and tolerances • pre-swaged male threads

Thread matches

Female thread:
 G 1/8" ≈ 8,6mm
 G 1/4" ≈ 11,5mm
 G 3/8" ≈ 15mm
 G 1/2" ≈ 18,6mm
 G 3/4" ≈ 24,1mm

Male thread:
 G 1/8" ≈ 9,7mm
 G 1/4" ≈ 13,2mm
 G 3/8" ≈ 16,7mm
 G 1/2" ≈ 21mm
 G 3/4" ≈ 26,4mm

NOTE

Find fitting pipe set p.45
 Find fitting pipe set p.39

Légende des pictogrammes :



Pneumatic tools



Painting guns



Flexibles



FRL



Grid wall lamp



Reels

ERP ENDS (x10) PASSAGE Ø7.2mm

FAST CONNECTORS EUROPEAN PROFILE Ø7.2mm



	SIZE	MALE THREAD	FEMALE THREAD	REF.	
	1/4"		•	OP 0917	
	1/4"	•		OP 0918	
	Ø8mm			OP 0919	
	Ø10mm			OP 0920	

	SIZE	MALE THREAD	FEMALE THREAD	REF.	
	1/4"		•	OP 0717	
	3/8"		•	OP 0718	
	1/2"		•	OP 0719	
	1/4"	•		OP 0720	
	3/8"	•		OP 0721	
	1/2"	•		OP 0722	
	Ø8mm			OP 0723	
	Ø10mm			OP 0724	

NOTE

Ø7.2mm passage is recommended for painting applications.



IRP ENDS (x10) PASSAGE Ø6mm

FAST CONNECTORS ISO PROFILE Ø6mm

NOTE

ø6mm passage is recommended for LV workshop.



	SIZE	MALE THREAD	FEMALE THREAD	REF.	
	1/4"		•	OP 0901	
	3/8"		•	OP 0902	
	1/4"	•		OP 0903	
	3/8"	•		OP 0904	
	Ø8mm			OP 0906	
	Ø10mm			OP 0907	

	SIZE	MALE THREAD	FEMALE THREAD	REF.	
	1/4"		•	OP 0701	
	3/8"		•	OP 0702	
	1/2"		•	OP 0703	
	1/4"	•		OP 0704	
	3/8"	•		OP 0705	
	1/2"	•		OP 0706	
	Ø8mm			OP 0708	
	Ø10mm			OP 0709	

IRP ENDS (x10) PASSAGE Ø8mm

FAST CONNECTORS ISO PROFILE Ø8mm

NOTE

ø8mm passage is recommended for HGV workshop.



	SIZE	MALE THREAD	FEMALE THREAD	REF.	
	1/4"		•	OP 0908	
	3/8"		•	OP 0909	
	1/2"		•	OP 0910	
	1/4"	•		OP 0911	
	3/8"	•		OP 0912	
	1/2"	•		OP 0913	
	Ø8mm			OP 0914	
	Ø10mm			OP 0915	
	Ø13mm			OP 0916	

	SIZE	MALE THREAD	FEMALE THREAD	REF.	
	3/8"		•	OP 0710	
	1/2"		•	OP 0711	
	3/8"	•		OP 0712	
	1/2"	•		OP 0713	
	Ø8mm			OP 0715	
	Ø13mm			OP 0716	





BLOWGUNS

STRAIGHT BLOWGUN PEN

TN

OP 0099



- pocket blowgun
- adjustable flow
- duralumin body
- length 110mm
- opening/closure by rotation



VARIABLE BLOWGUN BLACK METALLIC NOZZLE

TN

OP 0520

NEW



Specifications:

- brass insert: 1/4-F
- progressive blowing
- nominal pressure: 8bar
- temperature: -20°C+70°C
- material: Composite



OILER

TN

SA 6206

Spare part of OP 1510/OP 1206/OP 1214/OP 1232/OP 1210/OP 1204/OP 1203/OP 1205/OP 1413/OP 1418/OP 1209/OP 1513/OP 1502/OP 1402/OP 1532/OP 1405/OP 1409/OP 1407/OP 1422/OP 1460/OP 1450/OP 1451/OP 1218/OP 1470/OP 1580/OP 1480/OP 0500



1/4 AIR SPIRAL HOSE L.7.5m

TN

OP 0375



1/4" ROTATING UNION

TN

OP 0374





AIR IMPACT WRENCHES

1/2" D. IMPACT WRENCH 1600Nm DOUBLE HAMMER

TN

OP 1522BL

B.LINE
BUDGET SOLUTION

1/2"

NEW



+ One-hand reverser

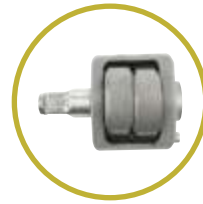

Double hammer



6 blade rotor



Removable air intake grille for easy cleaning

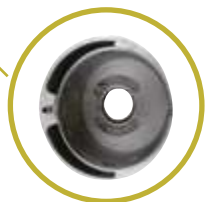

Steel cage for long service life Less vibration at high torque



Lightweight, highly resistant double-injection composite handle



Specifications:

- dual hammer technology
- loosening torque: 1600Nm
- tightening torque: 850Nm
- speed: 8,500 rpm
- connection: 1/4"
- recommended hose Ø: 10mm
- supply pressure: 6.2bar
- consumption: 170l/min
- length: 185mm
- net weight: 2.1kg
- supplied with connector

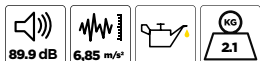

1600Nm





1/2" D. IMPACT WRENCH SET 1600Nm FOR WHEELS (19 PCS)

OP 1550BL

1/2"

B.LINE
BUDGET SOLUTION

NEW

+ All in one



OP 1522BL



OS 3100



OM 7003BL

Specifications:

- double hammer technology
- loosening torque: 1600Nm
- max tightening torque: 850Nm
- speed: 8.500rpm
- connection: 1/4"
- recommended hose Ø: 10mm
- supply pressure: 6.2bar
- consumption: 170l/min
- length: 185mm
- net weight: 2.1kg

Contents:

- OP1522BL: 1/2" impact wrench
- 3 special aluminium wheel sockets: 17-19-21mm
- 10 1/2" hexagon sockets: 9-10-11-13-14-17-19-22-24-27mm
- 1/2" extension 125mm
- 4mm hex key
- oil
- oiler
- pneumatic bit



OS 6999



SA 6206



1600Nm



WARRANTY



TN

1/2" D. COMPACT IMPACT WRENCH 1200Nm

OP 1523

1/2"

NEW

One-hand reverser



4 positions:
1 loosening
3 tightening



6 blade rotor

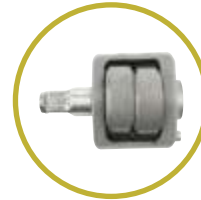

Double hammer



Air circulation
around the rotor for
cooling

+ Only 125mm long



1/2 "heavy-duty
anvil

Features :

- 4-position variator
- exhaust handle
- one-hand reverser

EN ISO 15744:2008
EN ISO 4871
EN ISO 11148-6:2012

Specifications:

- dual hammer technology
- loosening torque: 1200Nm
- tightening torque: 550Nm
- speed: 12,000 rpm
- connection: 1/4"
- recommended hose Ø: 10mm
- supply pressure: 6.2bar
- consumption: 170l/min
- length: 125mm
- net weight: 1.25kg



Removable air
intake grille for easy
cleaning



Lightweight, highly
resistant double-
injection composite
handle



1200Nm

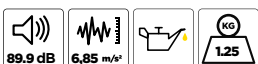



MUST-HAVE

TN

1/2" D. IMPACT WRENCH 2230Nm DOUBLE HAMMER

OP 1504

NEW

Features:

- 4-position variator
- exhaust handle
- one-hand reverser

EN ISO 15744:2008
 EN ISO 4871
 EN ISO 11148-6:2012

Specifications:

- double hammer technology
- loosening torque: 2230Nm
- max tightening torque: 1000Nm
- speed: 7.500rpm
- connection: 1/4"
- recommended hose Ø: 10mm
- supply pressure: 6.2bar
- consumption: 170l/min
- length: 185mm
- net weight: 2.2kg

+ Powerful One-hand clamping/unclamping reversal



1/2"

2230Nm

2 WARRANTY

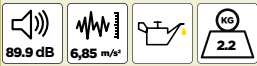

NOTE

Impact sockets on clas.com



3/4" D. IMPACT WRENCH 2298Nm DOUBLE HAMMER

OP 1534

NEW

Features:

- 4-position variator
- exhaust handle
- one-hand reverser

EN ISO 15744:2008
 EN ISO 4871
 EN ISO 11148-6:2012

Specifications:

- double hammer technology
- loosening torque: 2298Nm
- max tightening torque: 1068Nm
- speed: 7.500rpm
- connection: 1/4"
- recommended hose Ø: 10mm
- supply pressure: 6.2bar
- consumption: 170l/min
- length: 185mm
- net weight: 2.4kg

+ A 3/4Dr. Powerful and compact



3/4"

2298Nm

2 WARRANTY

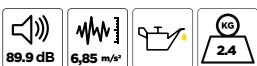



TN

1" D. IMPACT WRENCH 2441Nm

OP 1407

+ Ultra-light

- Powerful
- Horizontal work
- Anvil 210mm
- Throttle incorporated into the handle
- 3-position regulator
- Double-hammer technology
- Lateral exhaust

Specifications:

- max. torque: 2441Nm
- release torque: 2033Nm
- speed: 6,000rpm
- length: 467mm
- connection: 1/2"
- supply pressure: 6.2bar
- consumption: 282l/min
- net weight: 7.5kg

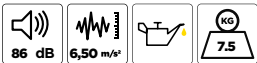

2441Nm **2** WARRANTY

1"



1" D. HGV IMPACT WRENCH 3390Nm

OP 1422

- Powerful
- Horizontal work
- Anvil 210mm
- Throttle incorporated into the handle
- 3-position regulator
- Double-hammer technology
- Lateral exhaust

Specifications:

- max. torque: 3390Nm
- speed: 5,000rpm
- length: 565mm
- connection: 1/2"
- supply pressure: 6.2bar
- consumption: 282l/min
- net weight: 11kg

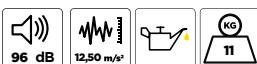

3390Nm **2** WARRANTY

1"





AIR RATCHET WRENCHES

TN

3/8" D. RATCHET WRENCH

OP 1413

- Quiet
- Integrated speed regulator
- Needle bearing
- Reinforced head
- Ergonomic handle
- Reversible
- Swiveling connector
- Rear exhaust

Specifications:

- max. torque: 68Nm
- working torque: 14 to 68Nm
- speed: 150rpm
- length: 256mm
- connection: 1/4"
- supply pressure: 6.2bar
- consumption: 113l/min



3/8"

Connector supplied



1/2" D. RATCHET WRENCH

OP 1209

- quiet
- light
- integrated speed regulator
- needle bearing
- reinforced head
- ergonomic handle
- reversible
- swiveling connector
- rear exhaust

Specifications:

- max. torque: 68Nm
- working torque: 14 to 68Nm
- speed: 150rpm
- length: 256mm
- connection: 1/4"
- supply pressure: 6.2bar
- consumption: 113l/min



1/2"

Connector supplied



1/4"-3/8" D. MINI RATCHET WRENCH KIT

OP 1510

Specifications:

- speed: 850rpm
- max torque: 40.7Nm
- consumption: 113l/min
- length: 155mm
- 3 positions: forward/reverse/fixe

Contents:

- connector
- SA1510: square reversible adapter 1/4"-3/8"
- bit holder adapter

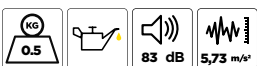

1/4"-3/8"

Connector supplied





AIR DRILLS

Ø13mm REVERSIBLE DRILL

OP 1451

- Two-speed trigger
- Automatic chuck
- Silent
- Composite housing
- Ergonomic handle + additional handle
- Swivelling connector
- Bottom exhaust with silencer
- Reversing bar on both sides
- Inversion of the rotation direction with one hand accessible from both sides

Specifications:

- motor: 0.5cv
- speed: 800rpm
- length: 218mm
- connector: 1/4"
- supply pressure: 6.2bar
- consumption: 113l/min



Connector supplied

TN



DRILL SET HSS4241 (170 PCS)

EG 0671BL



TN



DRILL SET HSS COBALT 5% (170 PCS)

EG 0681



TN



DRILL SET HSS4241 (25 PCS)

EG 0670BL



TN



25PCS DRILL SET HSS COBALT 5%

EG 0680



TN





TN

AIR RIVETER KIT

OP 1475



NOTE

Drill sets p. 124



Connector supplied

Specifications:

- rivet capacity up to 4.8mm depending on the bit
- traction power: 900kg
- stroke length: 14mm
- bits: 2.4-3.2-4-4.8mm
- air inlet: 1/4"
- air pressure: 6.2bar
- consumption: 1.4 to 1.8l/min



SA 1475 5 PCS NOZZLES+RIVETER JAWS SET



SPOT DRILL

OP 1460

- quiet
- low speed/high torque
- locking swivel clamp
- ergonomic handle
- rotating intake connection
- bottom exhaust
- carbide burr not included



Connector supplied

Specifications:

- speed: 800tr/min
- for reamer: Ø6.3/8.3/10.3x47mm
- length: 349mm
- connection: 1/4"
- supply pressure: 6.2bar
- consumption: 113l/min



SA 1460 CARBIDE REAMER 8.3x47mm





AIR CUTTING TOOLS

VIBRO CHISEL SET

OP 1580

Chisel set for easier removal of corroded, seized or crimped parts.



Specifications:

- capacity: 3200bpm
- operating pressure: 6.5bar
- connector 1/4"
- consumption: 180l/min

Contents:

- SA1586: vibro chisel
- SA1580: spring
- SA1581: flat chisel 20mm
- SA1582: curved chisel (welding spots+rivets)
- SA1583: punch
- SA1584: cutting chisel
- SA1585: splitter chisel
- accessories: Ø10mm
- length of accessories plug: 43mm



PNEUMATIC CHISEL TOOLS

OP 1480



Chisel set for an easier removal of corroded, seized or crimped parts.

Specifications:

- capacity: 2200bpm
- operating pressure: 5 to 8bar
- consumption: 114l/min
- noise level 100dB

Contents:

- SA1480: chipping/chisel hammer
- SA1481: adapter for 1/2" D. impact sockets
- SA1482: adapter for Ø38-63-74mm blocks
- SA1483: circular shaped block Ø38mm
- SA1484: rounded hollow block Ø63mm
- SA1485: circular shaped block Ø74mm
- SA1486: circular shaped block Ø25mm
- SA1487: rounded hollow block Ø25mm
- SA1488: 10pcs O-rings





10mm AIR BODY SAW

OP 1470

- light
- composite body
- low vibration
- swiveling connector
- safety trigger
- ergonomic handle with protection



Supplied with:

- connector
- SA1470: 24-tooth blade 74mm
- SA1471: 32-tooth blade 74mm

Specifications:

- strokes/min: 9500
- stroke length: 10mm
- length: 300mm
- connector: 1/4"
- supply pressure: 6.2bar
- consumption: 90l/min

Options:

SA1472: set of 5 blades with 24 teeth + 5 blades with 32 teeth



SA 1470	24-TOOTH BLADE
SA 1471	32-TOOTH BLADE

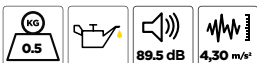

REVERSIBLE DISK-SANDER

OP 1214 180 €VAT Excl.

- powerful
- composite housing
- reversing bar on both sides
- rear exhaust with silencer



Connector supplied

Specifications:

- speed: 16,000rpm
- plates: 75/100/125mm
- motor: 0.60cv
- length: 142mm
- connector: 3/8"
- supply pressure: 6.2bar
- consumption: 113l/min





AIR GRINDERS

MINI DIE GRINDER Ø6mm 25,000rpm

OP 1203

Specifications:

- speed: 25,000rpm
- length: 159mm
- connection: 1/4"
- supply pressure: 6.2bar
- consumption: 113l/min



- lightweight
- grip handle
- safety trigger
- rear exhaust with silencer
- variable speed drive
- rotating intake connection

Connector supplied



CO 1201	ABRASIVE HOLDER DISC TRAY SUPPORT AXLE Ø50mm	Accessory of OP 1421/OP 1203/OP 1204/OP 1205/CO 1202
CO 1202	ABRASIVE DISC HOLDER TRAY Ø50mm	Accessory of OP 1203/OP 1204/OP 1205/CO 1201/CO 1203/CO 1204/CO 1205
CO 1203	50 ABRASIVE DISCS P40 Ø50mm	Accessory of OP 1203/OP 1204/OP 1205/CO 1202
CO 1204	50 ABRASIVE DISCS P60 Ø50mm	Accessory of OP 1203/OP 1204/OP 1205/CO 1202
CO 1205	50 ABRASIVE DISCS P80 Ø50mm	Accessory of OP 1203/OP 1204/OP 1205/CO 1202
SA 1203	DRILLED SHAFT SUPPORT DISKS	Accessory of OP 1203/OP 1204/OP 1205



MINI DIE GRINDER Ø6mm 20,000rpm

OP 1204

Specifications:

- speed: 20,000rpm
- length: 188mm
- connection: 1/4"
- supply pressure: 6.2bar
- consumption: 113l/min



- Light
- Grip handle
- Safety throttle
- Rear exhaust with silencer
- Speed regulator
- Swiveling connector

Connector supplied



MUST-HAVE

MINI ANGLE DIE GRINDER Ø6mm

OP 1205

Specifications:

- speed: 20,000rpm
- angle: 115°
- vibration: 1.24m/s²
- connection: 1/4"
- supply pressure: 6.2bar
- consumption: 113l/min



- Light
- Grip handle
- Safety throttle
- Rear exhaust with silencer
- Speed regulator
- Swiveling connector

Connector supplied





TN

RUBBER GRINDER

OP 1222

OPI203 : 1 x mini die grinder ø6mm 25,000rpm
SA1421 : 1 x gum ø86mm
SA1422 : 1 x adapter

NEW



MUST-HAVE

TN

MULTI-SERVICE BRUSH

OP 1210 427 €VAT Excl.

- light
- safety guard
- grip handle + auxiliary handle
- use with gum or brush
- safety throttle
- rear exhaust



Specifications:

- speed: 3,500rpm
- length: 280mm
- connection: 1/4"
- supply pressure: 6.2bar
- consumption: 110l/min

Supplied with:

- connectors
- SA1210: metal brush L.23mm
- SA1213: adapter for gum and brush Ø23mm



SA 1209	WIRE BRUSH (FINE) L.23mm
SA 1210	METAL BRUSH L.23mm
SA 1211	HARD GUM Ø105mm
SA 1212	SOFT GUM Ø105mm
SA 1213	ADAPTER FOR GUM AND BRUSH

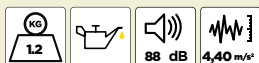

MICROGRAIN PNEUMATIC SANDBLASTING BOOTH

TN

OP 0618

This sandblasting booth is ideal for microblasting average sized parts. Hooked up to the workshop's air system, it allows you to blast abrasives for cleaning and restoring, making parts look like new.

Specifications:

- glazed access hatch
- hatch protective film
- neon interior light
- reinforced rubber handing gloves
- compatible with abrasives: microbead glass, corindon, shot, plastic media
- gun supplied with 4 ceramic nozzles (Ø 4, 5, 6 et 7mm)
- external dimensions: L.625xH.490xD.490mm
- internal dimensions: L.490xH.395xD.290mm
- air flow: 1.5m³ at 80psi.

Spare parts:

- SA6614: drum of synthetic sand 25kg (not included)
- SA0640: gun
- SA0641: ceramic nozzle
- SA0642: glove clamp
- SA0643: gloves
- SA0644: plexiglass for trapdoor
- SA0645: air filter



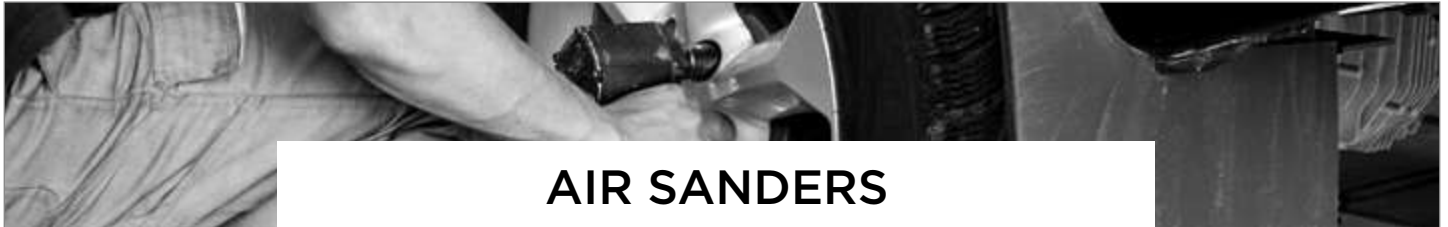

AIR SANDERS

TN

5mm RANDOM ORBITAL PALM SANDER Ø150mm

OP 1311

Specifications:

- speed: 12,000rpm
- orbit: 5mm
- pad: Ø150mm
- length: 196mm
- connector: 1/4"
- supply pressure: 6.2bar
- consumption: 57l/min
- net weight: 0.7kg
- ultra-light composite body with anti-vibration belt
- speed regulator
- rear exhaust
- Ø32mm connection for cuff
- one-handed use

2.5mm RANDOM ORBITAL PALM SANDER Ø150mm

OP 1312

Specifications:

- speed: 12,000rpm
- orbit: 2.5mm
- plate: Ø150mm
- length: 196mm
- connector: 1/4"
- supply pressure: 6.2bar
- consumption: 57l/min
- net weight: 0.7kg
- ultra-light composite body with anti-vibration belt
- speed regulator
- rear exhaust
- Ø32mm connection for cuff
- one-handed use

Connector supplied



CO 1312	3 FLEXIBLE INTERFACES Ø150/5mm
CO 1313	3 FLEXIBLE INTERFACES Ø150/10mm
CO 1311	MEDIUM MULTI-HOLE VELCRO® TRAY Ø150mm/8mm



10mm BELT SANDER

OP 1445

Specifications:

- speed: 18,000rpm
- belt: 10mmx330mm
- max. length: 330mm
- length folded: 207mm
- connection: 1/4"
- supply pressure: 6.2bar
- consumption: 116l/min

- Safety throttle
- Covered grip
- Handle exhaust + silencer
- Swiveling connector
- Safety lever



Connector supplied



TN



GUN

AIR CAULKING GUN

OP 5061

For the application of silicons, glues and putties with 310ml cartridges.

Specifications:

- aluminum body
- total length: 325mm
- 1/4" connection
- supply pressure: 5bar
- progressive trigger to enable speed control



Connector supplied



TN

PNEUMATIC GUN FOR 370mm CARTRIDGES AND BAGS

OP 5060

For silicons, glues, putties application with 310ml cartridges and 300,400 and 600ml bags.

Specifications:

- aluminum body and ring
- total length: 470mm
- length: 370mm
- height: 270mm
- sound level: 80dB
- air pressure inlet regulator from 4 to 8bar (10bar maximum) with 1/4" connection
- valve strength: 160kgf to 8bar
- progressive trigger to enable speed control



Connector and plastic spout supplied



TN

CARTRIDGE SPRAY GUN (POLYMER MS)

OP 1338

Allows the application of sealants, seals and waterproofing adhesives sprayable with 310ml cartridges. Spray or extrusion application.



Specifications:

- adjustable pressure and flow rate
- operating pressure: 3-5bar

Supplied with spray and extrusion nozzle

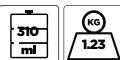

TN

PNEUMATIC GREASE GUN 450ml

OP 0521

NOTE

Grease pump p. 82



Specifications:

- nozzle length: 170mm
- capacity: 450ml
- operating pressure: 6.2bar
- weight: 1.8kg



TN



SMALL WORKSHOP EQUIPMENT

FOLDABLE INSPECTION CREEPER

EG 0113BL

NEW

Workshop creeper

Can be dismantled into 2 parts, with 4 swivel castors, easy to transport in a trunk.
 Comfortable, padded cushion and headrest.

B.LINE
 BUDGET SOLUTION

Specifications:

- dimensions: 92x38x9.5cm

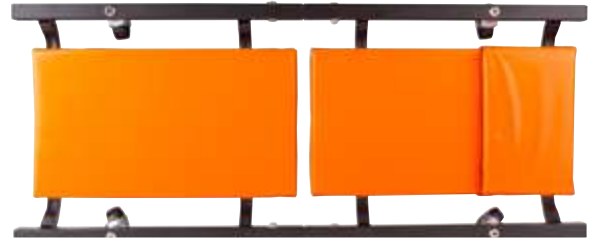

TN

2
 WARRANTY

6-WHEEL BUCKET-SEAT INSPECTION CREEPER

EG 0106

Specifications:

- supplied with 2 tool racks
- carrying handle
- hydrocarbon-proof material
- dimensions: 100x48x11cm
- wheel Ø: 60mm
- high-pressure washable



Max. Kg
 100

TN

2
 WARRANTY

INSPECTION CREEPER 150kg

EG 0109

Specifications:

- equipped with 2 tool holders
- carrying handle
- hydrocarbon-resistant material
- dimensions: 100x47x13cm
- Wheel Ø: 75mm
- high pressure washable
- reinforced wheel support



Max. Kg
 150

TN

2
 WARRANTY

TOOL-STORAGE STOOL

OM 0099

Specifications:

- height-adjustable
- 2 levels of tool storage
- allows you to work on all low parts
- h. min.: 440mm
- h. max.: 560mm
- weight capacity: 113kg



Max. Kg
 113

TN

2
 WARRANTY



TN

MUST-HAVE

900W INDUSTRIAL BENCH GRINDER
Ø200x32x32mm WHEEL+BRUSH

EG 0225

Specifications:

- adjustable protective screen with magnifying lens
- dual extractor vent
- speed: 2950 rpm

Fixing:

- 250mm wide centre distance
- 155mm deep centre distance

Supplied with:

- brush Ø200mm
- grinding wheel grit 60



EG 0221 BENCH GRINDER BRUSH

EG 0273 VITRIFIED GRINDING WHEEL GREY CORUNDUM 200x32x32mm GRIT 60



PARALLEL JAW CLAMPS 150mm
QUICK TUBE HOSE APPROACH

OM 4066

Specifications:

- jaw width: 150mm
- jaw height: 20mm
- opening: 180mm
- interchangeable steel jaws
- supplied with revolving base with 3 anchoring points

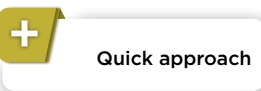

Releasable jaw system allowing you to make adjustments to the jaw immediately.



PARALLEL JAW CLAMPS 205mm QUICK
TUBE HOSE APPROACH

OM 4068

Specifications:

- jaw width: 205mm
- jaw height: 22mm
- interchangeable steel jaws
- tube, anvil and horn jaws
- jaw opening: 260mm
- useful height inside the vice: 95mm
- supplied with revolving base with 3 anchoring points (180x225mm)
- power take-off for tube diameter max 75mm

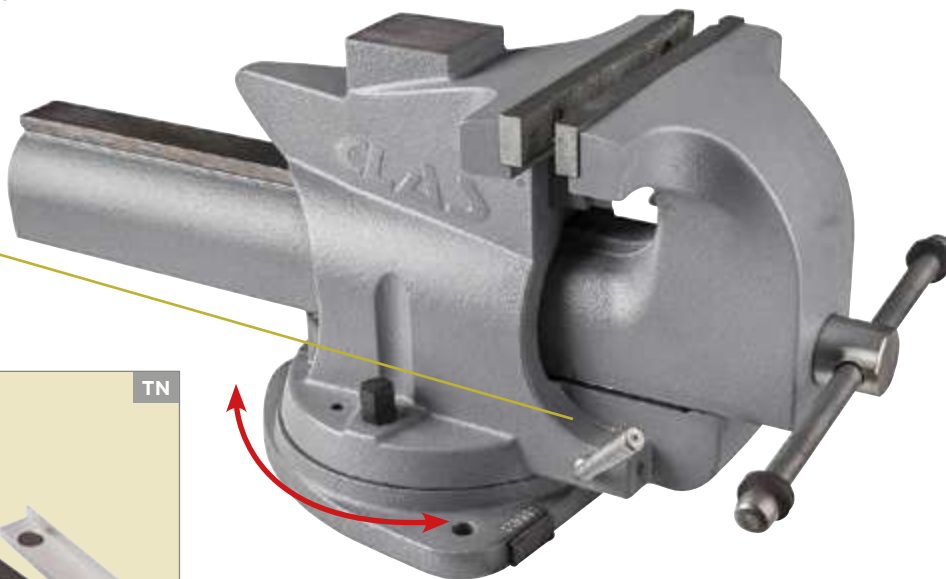

OPTIONS

150mm 2 RUBBER COATING
MAGNETIC JAW SET

EG 7053

Accessory of OM 4066



200mm 2 RUBBER COATING
MAGNETIC JAW SET

EG 7054

Accessory of OM 4068



EG 7050 2 JAW 150mm SET

EG 7051 2 JAW 200mm SET





HOT AIR GUN 50-650°C

OE 6047

TN

Specifications:

- LCD display
- last temperature memorized
- 5 options for airflow from 250 to 500l/min
- heat constant control (protects against overheating and ensures a continuous job)
- handle for a comfortable job
- operating temperature range: 50-650°C



- Supplied with:
- 1 protective nozzle
 - 1 flat nozzle
 - 1 reduction nozzle
 - 1 reflective nozzle
 - 1 scraper



SOLDERING IRON 30W WITH STAND

OE 0811

TN

This soldering iron is ideal for a multitude of works. The high quality tip is suitable for lead-free soldering.

The work stand has two crocodile clips for holding electronic boards.
Weight: 560g



Delivered with tin, tips and sponge

SA 0811	100g TIN	Spare part of EG 0050 Accessory of OE 0811	14 €VAT Excl.
---------	----------	---	---------------



PORTABLE GAS SOLDERING IRON

EG 0050

TN



Specifications:

- solder up to 500°C
- 4-position adjustment
- supplied with 4 tips
- after-use support





TN

MINI TORCH WITH RETRACTABLE TUBING + GAS REFILL

EG 0541

Contents:

- EG0540: mini torch with retractable tubing
- EG0047: gaz refill



EG 0540	MINI TORCH WITH RETRACTABLE TUBING
SA 0541	RANGE OF RETRACTABLE SLEEVES
EG 0047	GAS REFILL
SA 0540	MINI TORCH



WIRE BRUSH

EG 0056



Handy steel wire metallic brush ideal for a multitude of uses.

- carbon steel wire
- soft grip handle



TN

WHITE WASHABLE MARKER FOR ALL SURFACES

EG 0021

Water based washable paint marker

Specifications:

- UV resistant
- for all surfaces: metal, plastic, wood, glass, stone, foil...
- transparent body so you can immediately see how much paint is left
- VOC less than 0.6% (Volatile Organic Compounds)
- complies with standard ASTM D436 (non toxic)



TN



MAGNETIC FLEXIBLE PICK UP TOOL Ø5mm L.525mm

OM 8088



TN



MAGNETIC FLEXIBLE PICK UP TOOL Ø5mm L.1070mm

OM 8086



MUST-HAVE

LONG FLEXIBLE MAGNETIC SHAFT

OM 8087

This tool allows small objects to be retrieved and picked up in confined areas. The 4 curved claws ensure a correct grip, and the powerful magnet is ideal for metallic objects.

Specifications:

- total length: 700mm
- magnet Ø15mm
- flexible shaft and aluminum bracket

+ 2-in-1 product

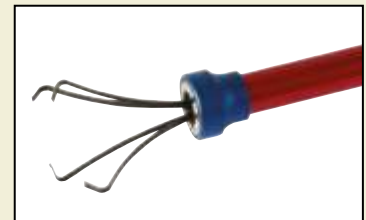

TELESCOPIC MAGNET 170mm-670mm

OM 8071



TN

TELESCOPIC MIRROR 228mm-715mm

OM 8074



TN





TN

RIVETING PLIERS

OM 0749BL

Specifications:

- handle sheathed with return spring
- supplied with 4 nozzles Ø2.4-3.2-4.0-4.8mm
- key for nozzle assembly
- length: 270mm



B.LINE
BUDGET SOLUTION

NO WARRANTY

PRO PLIERS FOR RIVETS & LOCKNUTS

OM 0480

Suitable for:

- rivets Ø2.4-3.2-4-4.8-6.4mm
- locknuts Ø4-5-6-8-10mm

NOTE

Pneumatic solution
See p. 94

TN



Contents:

- m4-M5-M6-M8-M10 pull spindles
- 3.2-4.0-4.8 et 6.4mm nozzles

SA 1489 REPAIR KIT FOR RIVETING PLIERS

Spare part of OM 0480

2 WARRANTY

THREADED RIVET SET (150 PCS)

CO 0480

Contents:

- 25 rivets M3x9mm
- 25 rivets M4x11mm
- 25 rivets M5x13mm
- 25 rivets M6x15mm
- 25 rivets M8x18mm
- 25 rivets M10x21mm

SA 2481	THREADED RIVET M3x9mm (25 PCS)	3 €VAT Excl.
SA 2482	THREADED RIVET M4x11mm (25 PCS)	3 €VAT Excl.
SA 2483	THREADED RIVET M5x13mm (25 PCS)	3 €VAT Excl.
SA 2484	THREADED RIVET M6x15mm (25 PCS)	3 €VAT Excl.
SA 2485	THREADED RIVET M8x18mm (25 PCS)	4 €VAT Excl.
SA 2486	THREADED RIVET M10x21mm (25 PCS)	5 €VAT Excl.



TN

NO WARRANTY



4 HOOK SET FOR JOINTS

OM 9216

Special hooks for joints L.130mm



TN

LEVER SET WITH STRIKE DISK (4 PCS)

OM 0258



Contents:

- SA0242: lever with strike disk L.200mm
- SA0243: lever with strike disk L.300mm
- SA0244: lever with strike disk L.450mm
- SA0246: lever with strike disk L.600mm



TN



NUT SPLITTER

OM 0623

This set allows the operator to quickly remove corroded, seized or damaged nuts.
The principle is simple: the nut is sheared to release the screw thread.
Practical and easy to use, this nut splitter set is a must-have in every workshop.



Contents:

- SA0624: nut splitter for nuts from 9 to 12mm
- SA0625: nut splitter for nuts from 12 to 16mm
- SA0626: nut splitter for nuts from 16 to 24mm
- SA0627: nut splitter for nuts from 22 à 27mm



TN



TN

419 PIECE O-RING JOINT SET

EG 0525

Suitable for: fuel, oil, acid.

- | | | |
|------------------|-------------------|-------------------|
| Contents: | 14pcs. 16x2.5mm | 10pcs. 28x3.5mm |
| 20pcs. 3x1.5mm | 14pcs. 18x2.5mm | 10pcs. 30x3.5mm |
| 20pcs. 4.4x2mm | 13pcs. 19x2.5mm | 10pcs. 31x3.5mm |
| 18pcs. 5x2mm | 14pcs. 21x2.5mm | 10pcs. 33x3.5mm |
| 23pcs. 7x1.5mm | 13pcs. 22x2.5mm | 10pcs. 34.5x3.5mm |
| 23pcs. 10x1.5mm | 10pcs. 18x3.5mm | 10pcs. 36x3.5mm |
| 23pcs. 13x1.5mm | 10pcs. 20x3.5mm | 10pcs. 38x3.5mm |
| 14pcs. 10x2.5mm | 10pcs. 22x3.5mm | 10pcs. 41x3.5mm |
| 13pcs. 11x2.5mm | 10pcs. 23.5x3.5mm | 10pcs. 44x3.5mm |
| 14pcs. 13x2.5mm | 10pcs. 25x3.5mm | 10pcs. 47x3.5mm |
| 13pcs. 14x2.5mm | 10pcs. 26.5x3.5mm | 10pcs. 50x3.5mm |



E TYPE EXTERNAL CIRCLIP SET 1.5-22mm (300 PCS)

CO 0525

- | | |
|------------------|------------|
| Contents: | • 10mm x50 |
| • 1.5mm x30 | • 12mm x40 |
| • 3mm x30 | • 15mm x20 |
| • 5mm x40 | • 19mm x20 |
| • 6mm x50 | • 22mm x20 |



TN

3-32mm EXTERNAL CIRCLIP SET (300 PCS)

CO 0527

- | | |
|------------------|------------|
| Contents: | • 14mm x15 |
| • 3mm x20 | • 16mm x20 |
| • 4mm x10 | • 19mm x25 |
| • 5mm x15 | • 20mm x15 |
| • 6mm x25 | • 22mm x20 |
| • 8 mm x15 | • 25mm x15 |
| • 9mm x20 | • 26mm x15 |
| • 11mm x15 | • 28mm x10 |
| • 12mm x15 | • 32mm x5 |
| • 13mm x25 | |



3-32mm INTERNAL CIRCLIP SET (300 PCS)

CO 0526

- | | |
|------------------|------------|
| Contents: | • 14mm x15 |
| • 3mm x20 | • 16mm x20 |
| • 4mm x10 | • 19mm x25 |
| • 5mm x15 | • 20mm x15 |
| • 6mm x25 | • 22mm x20 |
| • 8 mm x15 | • 25mm x15 |
| • 9mm x20 | • 26mm x15 |
| • 11mm x15 | • 28mm x10 |
| • 12mm x15 | • 32mm x5 |
| • 13mm x25 | |



LUBRICANT SILICONE UNIVERSAL SPRAY 500ml

CO 1030



+ Anti corrosion
Anti oxidation

Also available in box of 12

LUBRICANT TEFLON SPRAY 500ml

CO 1031



+ Without residues of
fat and silicone: dust
does not stick.

Also available in box of 12

SUPER RELEASING GRAPHITE SPRAY 400ml

CO 1026



+ Long-term
protection

Also available in box of 12

BLACK STRUCTURAL GLUE 50ml

CO 1024



+ Ideal for plastic
repair

Also available in box of 48

MASTIC REPAIR BAR TO MODEL METAL 57g

CO 1046



+ Can be drilled,
tapped, threaded,
filed, painted...

FLEXIBLE INSTANT GLUE 20g

CO 1032



+ Rapid and
instantaneous
adhesion

Also available in box of 48





INDUCTION HEATERS

MUST-HAVE

TN

INDUCTION HEATER

OE 0800

Allows a room to be heated in a precise area, meaning that nuts, screws, bolts, bolted connections, hubs (even if rusted), lambda probes, ball bearings can be unblocked...It also allows stickers to be easily removed and stuck door rods to be disassembled or HGV wheel screws to be removed.

+ Improved security
Time gain



Specifications:

- frequency: 25-60kHz
- automatic overheating shutdown
- short-circuit and open circuit security, overload alarm
- dimensions: 200x140x75mm

Contents:

- deported induction central unit with 3m supply cable and 70cm connector (to improve accessibility)
- SA0819: rigid induction coil Ø19mm length 220mm
- SA0832: rigid induction coil Ø32mm length 220mm
- SA0818: flexible coil length 800mm
- SA0817: induction pad Ø50mm length 220mm
- shoulder strap
- plastic case with foam



SA 0816	RIGID INDUCTION COIL Ø23mm	Spare part of OE 0800/OE 0610
SA 0817	ROUND INDUCTION PAD Ø50mm	Spare part of OE 0800/OE 0610
SA 0818	FLEXIBLE INDUCTION COIL	Spare part of OE 0800/OE 0610
SA 0819	RIGID INDUCTION COIL Ø19mm	Spare part of OE 0800/OE 0610
SA 0832	RIGID INDUCTION COIL Ø32mm	Spare part of OE 0800/OE 0610
SA 0838	RIGID INDUCTION COIL Ø38mm	Spare part of OE 0800/OE 0610



HGV INDUCTION HEATER

OE 0900

This tool allows to heat a part in a precise place, thus facilitating the unlocking of screws, nuts, bolts, rods, hubs (even rusty), lambda probes, ball bearings... It also makes it easy to remove stickers, remove glued door sticks or HGV wheel nuts.

+ Increased security
Saving time



It is a real alternative to the torch or flame torch: its induction system allows to heat precisely and without flame a metallic (conductive) part without risk of deterioration of the surrounding non-conductive parts (glass, plastic, paint...)

In addition, the operator saves considerable time when using the tool.

Contents:

- remote induction central unit with 3m mains cable and 2m connecting cable (for accessibility)
- induction coil with side heating

Specifications:

- frequency: 18-60kHz
- power: 3.7kVA
- power regulator: 10-100%
- control screen and timer
- LED illumination of the work area
- water-cooled
- dimensions: 240x200x440mm
- weight: 11.5kg





ELECTRONIC MEASURING INSTRUMENT

POLARITY/CONTINUITY TESTER 3 TO 48V

OE 0065BL

Voltage and battery tester for cars, HGVs and motorbikes.
 Positive/negative cables test.

B.LINE
 BUDGET SOLUTION

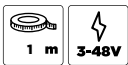

TN

UNIVERSAL NON INTRUSIVE TEST PROBE SET CAT. II

AC 5115

Suitable for all standard 4mm instrument sockets.

Contents:

- pair of test leads with straight and 90° connectors max. 1000V, L.120cm
- pair of cable piercers for intrusive measures taking max. 30V
- pair of slim probes for inversed tests max. 24V



TN

AMMETER CLAMP 1000A

OE 5020

Specifications:

- intensity test
- amperemeter test
- diode test
- continuity test
- data-hold function
- IEC 61010 CATII with overload protection
- 3 16mm digit backlit LCD screen
- automatic scales
- comes with battery and test lead
- aperture of the pliers: 55mm
- DC voltage: $600V \pm (0.5\% + 5)$
- AC voltage: $600V \pm (1\% + 5)$
- direct current: $200/1000A \pm (2.5\% + 5)$
- alternating current: $200/1000A \pm (2.5\% + 5)$
- resistance: $200 \text{ ohms} \pm (1.2\% + 5)$
- frequency: $2\text{kHz} \pm (2\% + 5)$
- power supply: 9Vx1



TN



TN

CAT.I DIGITAL MULTIMETER

OE 3008BL



Specifications:

- DC voltage: 200mV-2000mV-20V-200V-500V
- AC voltage: 200V-500V
- DC current: 200uA-20mA-200mA
- resistance: 200ohm-2000ohm-20Kohm-200Kohm-2000Kohm
- battery: 6LR61 PP3
- dimensions: 126x70x24mm



DIGITAL MULTIMETER CAT. III

OE 3004



Specifications:

- DC voltage: 200mV-2V-20V-200V-300V
- AC voltage: 200mV-2V-20V-200V-300V
- DC current: 20mA-200mA-10A
- AC current: 20mA-200mA-10A
- resistance: 200ohm-2kohm-20kohm-200kohm-2Mohm-20Mohm
- diode test: approx. 2.8V
- temperature: 0-1000°C
- battery test: 1.5-9V-12V
- continuity: <30ohm
- light at the top



BLACK TOUCH POINT IP2X FOR VAT DEVICE

OE 3011

Accessory of OE 3010

IP2X measuring tip with 4 mm female banana coupling, black. Hard tip to scrape varnish, paint, oxidation. Safety 1000 V CAT IV



Standard: IEC 61010-031



RED TOUCH POINT IP2X FOR VAT DEVICE

OE 3012

Accessory of OE 3010

IP2X measuring tip with 4 mm female banana coupling, red. Hard tip to scrape varnish, paint, oxidation. Safety 1000 V CAT IV



Standard: IEC 61010-031





TN

OSCILLOSCOPE

AC 5110

This portable oscilloscope is a measuring instrument combining a number of functions to help technicians in their diagnosis of car electrical circuits. It integrates the functions of the oscilloscope and the multimeter.

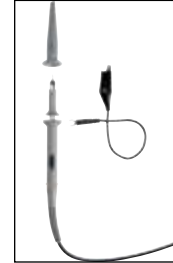

Voltage: peak to peak, average, RMS
 Frequency meter: Frequency/Period
 Resistance: 600ohm-6Kohm-60Kohm-600Kohm/6M-60Mohm
 Diode: =2V
 Mains adapter
 Computer interface
 Software: computer software
 3.6V lithium battery
 Weight: 700g (with battery)
 Band width: 20MHz
 Number of channels: 2
 Sampling rate: 100MEch/s
 Horizontal sensitivity: 10ns/div
 Horizontal precision: 0.01%
 Horizontal distinction: 10ns
 Vertical sensitivity: 5mV/div-20V/div
 Vertical precision: ± (5% 1 pixel)
 Vertical distinction: 8 bits
 Maximum input voltage: 300V
 Trigger Mode: Normal, Auto, Single
 Screen display: 80mmx60mm
 Back-lighting
 To record: 6 sets of waveforms and 10 sets of parameters
 Input impedance: 1MOhm, =20pF
 Channel isolation: 100:1

For collecting data on:

- voltage
- signals
- frequencies
- OCR (opening cyclic ratio)

Equipped with two measurement input points so two curves can be analyzed simultaneously.
 Example: comparing two sensors at the same time to compare the values of their signals.
 This device is essential for diagnosing electronic management systems and analyzing multiplex signals, commands and data from the different sensors.

Supplied with USB connector cable



NOTE
 Multimeter Megohmmeter (OE 4002) and VAT safety tester (OE 3010) p. 426





TAPS & DIES

DRILL SET HSS4241 (25 PCS)

TN

EG 0670BL

B.LINE
BUDGET SOLUTION

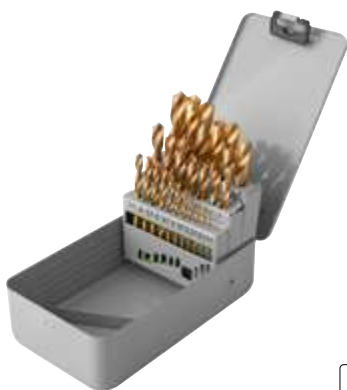

**25PCS DRILL SET
HSS COBALT 5%**

TN

EG 0680



DRILL SET HSS4241 (170 PCS)

TN

EG 0671BL

B.LINE
BUDGET SOLUTION



Composition:

- 10 drills bits of 1mm
- 10 drills bits of 1,5mm
- 10 drills bits of 2mm
- 10 drills bits of 2,5mm
- 10 drills bits of 3mm
- 10 drills bits of 3,5mm
- 10 drills bits of 4mm
- 10 drills bits of 4,5mm
- 10 drills bits of 5mm
- 10 drills bits of 5,5mm
- 10 drills bits of 6mm
- 10 drills bits of 6,5mm
- 10 drills bits of 7mm
- 10 drills bits of 7,5mm
- 10 drills bits of 8mm
- 5 drills bits of 8,5mm
- 5 drills bits of 9mm
- 5 drills bits of 9,5mm
- 5 drills bits of 10mm

DRILL SET HSS COBALT 5% (170 PCS)

TN

EG 0681



Composition:

- 10 drills bits of 1mm
- 10 drills bits of 1,5mm
- 10 drills bits of 2mm
- 10 drills bits of 2,5mm
- 10 drills bits of 3mm
- 10 drills bits of 3,5mm
- 10 drills bits of 4mm
- 10 drills bits of 4,5mm
- 10 drills bits of 5mm
- 10 drills bits of 5,5mm
- 10 drills bits of 6mm
- 10 drills bits of 6,5mm
- 10 drills bits of 7mm
- 10 drills bits of 7,5mm
- 10 drills bits of 8mm
- 5 drills bits of 8,5mm
- 5 drills bits of 9mm
- 5 drills bits of 9,5mm
- 5 drills bits of 10mm

Material: Cobalt HSS 5%

OIL CAN 500ml

TN

HU 0511



4-32mm HSS STEP DRILL

TN

EG 0432





DRILL-TAPS-DIES SET (37 PCS)

TN

OM 9221

Contents:

- 8 dies: 3x0.5-3.5x0.6-4x0.7-5x0.8-6x1.0-8x1.25-10x1.50-12x1.75
- 8 taper taps
- 8 bottoming taps in sizes shown
- 8 HSS drills 2.5/2.9/3.3/4.2/5/6.8/8.5/10.3mm
- + accessories



MUST-HAVE

TN

TAP & DIE SET (52 PCS)

OM 9222

Contents:

- 7 dies: M3x0.5/M4x0.7/M5x0.8/M6x1.0/M8x1.25/M10x1.50/M12x1.75
- 5 UNF dies 1/4", 5/16", 3/8", 1/2"
- 2 BSP dies 1/8", 1/4"
- 14 taps sizes as indicated
- 13 HSS drills: 2.5-3.3-4.2-5-5.5-6.8-6.9-8.5-8.8-9.9-10.3-11.4-11.8mm
- 5 pigtail extractor N°1-2-3-4-5
- + accessories



TAP & DIE SET (75 PCS)

TN

OM 9223

Contents:

- 18 dies: M2x0.25-M3x0.35-M3x0.5-M3.5x0.6-M4x0.5-M4x0.7-M4.5x0.75-M5x0.5-M5x0.8-M6x0.75-M6x1.0-M8x1.0- m8x1.25-M10x1.25-M10x1.5-M12x1.25-M12x1.75-BSP28 1/8"
- 18 taps coarse shank, dimensions see dies
- 18 taps fine shank, dimensions see dies
- 17 HSS drill bits: 1.7-2.5-2.6-2.9-3.3-3.5-3.8-4.2-4.5-5-5.3-6.8-7-8.5-8.8-10.3-10.7mm
- + accessories



5 CARBIDE ROTARY RASPS BOX

TN

OM 0643

Specifications:

- right cut
- diamond gearing
- 6mm cylindrical shank
- material: carbide



SCREW EXTRACTOR SET + HSS DRILLS Ø2-Ø7.5mm

TN

OM 0653

Contents:

- 5 pig tail extractors no.1-2-3-4-5
- 5 HSS drill bits Ø2-3-4-6.5-7.5





RETHRADING TOOLS

10 PCS M14x2.0
INSERT SET

OM 0458



Stainless steel inserts

TN



10 PCS M14x125
INSERT SET

OM 0457



Stainless steel inserts.
Special spark plug thread.

TN



OM 0486 M5x0.8 INSERT SET

Contents:

- drill Ø5.2mm
- tap M5x0.8
- running tool insert
- 25 stainless steel inserts

OM 0487 M6x1.0 INSERTS SET

Contents:

- drill Ø6.3mm
- tap M6x1.0
- running tool insert
- 25 stainless steel inserts

OM 0488 M8x1.25 INSERT SET

Contents:

- drill Ø8.3mm
- tap M8x1.25
- running tool insert
- 25 stainless steel inserts

OM 0489 M10x1.50 INSERT SET

Contents:

- drill Ø10.4mm
- tap M10x1.5
- running tool insert
- 25 stainless steel inserts

OM 0490 M12x1.75 INSERT SET

Contents:

- drill Ø12.4mm
- tap M12x1.75
- running tool insert
- 25 stainless steel inserts



TN



M5-M12 INSERT SET

OM 0450

For repairing worn or damaged threading. Inserts in stainless steel, highly resistant to breaking, corrosion and temperature. Box made up of inserts from M5 to M12, helical drills, taps, assembly tools and tang breakers.

Contents:

- helical drills
- taps
- assembly tools
- tang breakers
- 12 inserts M5x0.8 (OM0452: 25 inserts)
- 12 inserts M6x1 (OM0453: 25 inserts)
- 12 inserts M8x1.25 (OM0454: 25 inserts)
- 12 inserts M10x1.50 (OM0455: 25 inserts)
- 12 inserts M12x1.75 (OM0456: 10 inserts)



TN

OM 0452 25 PCS M5x0.8 INSERT SET

OM 0453 25 PCS M6x1 INSERT SET

OM 0454 25 PCS M8x1.25 INSERT SET

OM 0455 25 PCS M10x1.50 INSERT SET

OM 0456 10 PCS M12x1.75 INSERT SET





METRICAL INNER/OUTER THREAD FILE 0.8-3.0

TN

OM 9300

Allows the inner or outer thread to be measured in order to reform them by passing over the affected area.

Each side of thread has a different notch as follows:
 0.80-1.00-1.25-1.50-1.75-2.00-3.00
 Length: 230mm



MUST-HAVE

TN

EXTERNAL RETHREADING TOOL Ø17-Ø38mm

OM 9309

+ Reduced bulk

A single tool to restore both right and left hand threads in inches or metric!



Specifications:

- no calibration required
- automatically adjusts to any pitch/size
- automatically drives out the correct threads to repair damage
- 11/16"-1-1/2" 17-38mm
- pipe thread up to 3/8" - 1-1/8"
- 60° , ISO, UNC, UNF, NPT
- 55° , BSW, BSF, BSP



TAP HOLDERS AND RATCHET THREADERS BOX

TN

OM 9325



Contents:

- 1 ratchet 3/8"
- 2 die-holders Øext: 9 to 25mm
- 2 tap holders M3 to M12



CHOOSING THE RIGHT JACK.

Why choose a jack?

Before choosing a jack, there are several questions to ask yourself:

- what type of vehicle do I want to lift? VL, VUL, lowered...?
- what should my lifting capacity be?
- do I want to transport my jack?

Don't forget: the use of a jack goes hand in hand with the use of jackstands to secure the load. The jack lifts the vehicle, the stanchion holds it up.



THERE ARE 4 MAJOR JACK CATEGORIES

TROLLEY JACK

*Workshop star.
The ultra-low-profile versions can lift lowered cars.*



- +** High load capacity
Easy to move
Simple to use
Wide lifting range to fit different vehicles
- Space requirement

BOTTLE JACK

It is mainly dedicated to uses outside the workshop (mobile service)



- +** High load capacity
Low space requirement
Lightweight
- Stability

PNEUMATIC JACK

With 2 or 3 stages, that kind of jacks has an extended lifting range. It is often used as an auxiliary post lifts.



- +** Fast lifting
Space saving
Lightweight
- Air compressor required

AIR HYDRAULIC JACK

This type of jack is dedicated to heavy loads (trucks, buses, construction vehicles, tractors...)



- +** Very high load capacity
Fast lifting
Effortless lifting
- Air compressor required



FLOOR JACK (MOBILE SERVICE)



REF	OH 6302BL	OH 5304	OH 5311	OH 5309
Vehicle type				
Intensity of use				
Max. load	2T	2T	3T	1.25T
Height min.	135mm	85mm	192mm	85mm
Max. height	340mm	381mm	533mm	375mm
Lowering	braked	braked	braked	braked
Wheel	steel	steel	steel	alu/steel
Drive	offset	offset	offset	u-joint
Pump	mono piston	mono piston	mono piston	dual piston
Weight (kg)	8.7	12.6	19	11.5
Distribution				
Extra flat		•		•
Budget	€	€	€	€€

GARAGE JACK (WHORKSHOP)



REF	OH 5306	OH 6303	OH 7014	OH 5355	OH 5360
Vehicle type					
Intensity of use					
Max. load	2.25T	3T	3T	5T	10T
Height min.	140mm	130mm	75mm	150mm	160mm
Max. height	490mm	465mm	510mm	560mm	560mm
Lowering	braked	braked	braked	braked	braked
Approach pedal		•	•	•	•
Wheel	steel	steel	PU	steel	steel
Drive	gable	gimbal	gimbal	mechanics	mechanics
Pump	mono piston	dual piston	dual piston	mono piston	mono piston
Weight (kg)	29.5	30	30.5	87	129
Distribution					
Extra long			•		•
Extra flat			•		•
Budget	€€	€€€	€€€	€€€€	€€€€

AIR HYDRAULIC JACK



REF	OH 9021	OH 3015N	OH 9042N	OH 5030N	OH 9032N
Vehicle type					
Intensity of use					
Max. load	30T	30T	40T	50T	30T
Min. height	150mm	150mm	129mm	150mm	360mm
Max. height	289mm	289mm	276mm	300mm	627mm
Capacity per floor	30T/15T	30T/15T	40T/22T/10T	50T/30T/15T	30T
Lowering speed control	•	•	•	•	•
Transport	Poignée transport + manche pliable				
Weight (kg)	24	38	36	56	87
Distribution					
Budget	€	€	€€	€€	€€€



TROLLEY JACKS

TROLLEY JACK 2T

OH 6302BL

Specifications:

- rotating soleplate
- robust chassis
- anti-overload system
- transportation handle
- handle length: 740mm



B.LINE
BUDGET SOLUTION

TN



2T **2** WARRANTY

EXTRA FLAT TROLLEY JACK 2T 85mm

OH 5304

+ Extra low profile



Handle storage

Specifications:

- rotating saddle
- safety overload system



2T **2** WARRANTY

HIGH ELEVATION TROLLEY JACK 3T

OH 5311

+ Telescopic head (+5cm)



Specifications:

- rotating saddle
- safety overload system
- h. min.: 192mm
- h. max.: 533mm
- dimensions: 635x255x192mm
- weight: 19kg



Handle storage

3T **2** WARRANTY



TN

MUST-HAVE

EXTRA FLAT ALUMINUM TROLLEY JACK 1.25T 85mm

OH 5309



+ Ultra-light, ultra-flat,



Quick-fit handle

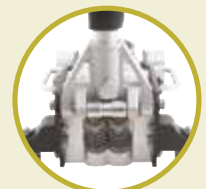

Double pump: rapid pump-up

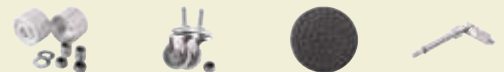

SA 5411	PAIR OF FIXED WHEELS Ø55x35mm
SA 5412	PAIR OF PIVOTING WHEELS Ø40x16mm
SA 5413	PAD
SA 5415	CV JOINT

Specifications:

- rubber pad
- safety overload system
- twin pump design
- protective foam on the handles
- swivelling rear castors

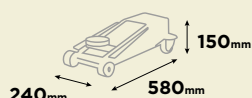

1.25T





TROLLEY JACK 2.25T

OH 5306



Sprockets

Specifications:

- robust chassis
- metered release system for a precise load control
- safety overload system
- swiveling steel saddle
- swivelling rear casters



SA 5364	PAD
SA 5391	PAIR OF FIXED WHEELS Ø90x33mm
SA 5392	PAIR OF PIVOTING WHEELS Ø60x25mm

490 mm
 140 mm
 METAL
 31 KG

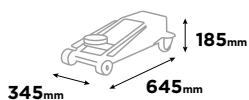

2.25T





TN

FOOT PEDAL TROLLEY JACK 3T

OH 6303

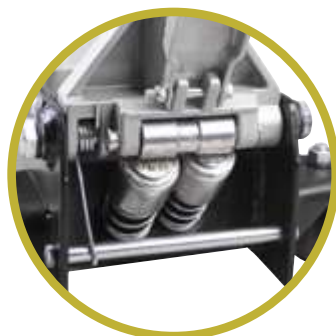

Double pump:
rapid pump-up

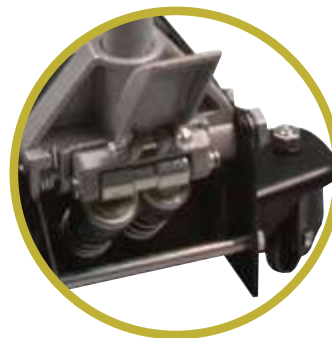

Approach pedal

Specifications:

- foot pedal
- anti-overload system







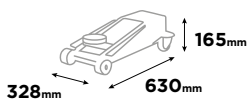







MUST-HAVE

TN

EXTRA FLAT TROLLEY JACK 3T 75mm

OH 7014

+ Extra low profile



Double pump: rapid pump-up



Approach pedal



Foam protection on handle



SA 7114 PAIR OF FRONT WHEELS

SA 7115 PAIR OF SWIVEL WHEELS

SA 7122 CV JOINT

Specifications:

- foot pedal
- control lowering system
- safety overload system
- swiveling rubber saddle

3T 10 WARRANTY



LONG CHASSIS TROLLEY JACK 5T L.1505mm

OH 5355



Bearing-mounted swivel wheels



Approach pedal

Specifications:

- anti-overloading system
- controlled lowering system
- foot pedal
- ball bearing front/rear wheels ensure stability and manoeuvrability
- SA5355: pair of swiveling wheels
- SA5356: pair of front wheels

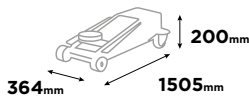

5T 10 WARRANTY

DIMENSIONS

REF	A (mm)	E (mm)	F (mm)	G (mm)	H (mm)	J (mm)	L (mm)	K (mm)	Handle length Handle lenght	Ø front wheels Front wheel Ø	Ø rear wheels Rear caster Ø
OH 5355	1505	31	31	200	290	364	245	130	1155mm	111mm	70mm
OH 5360	1637	24	24	250	333	490	245	150	1155mm	141mm	90mm

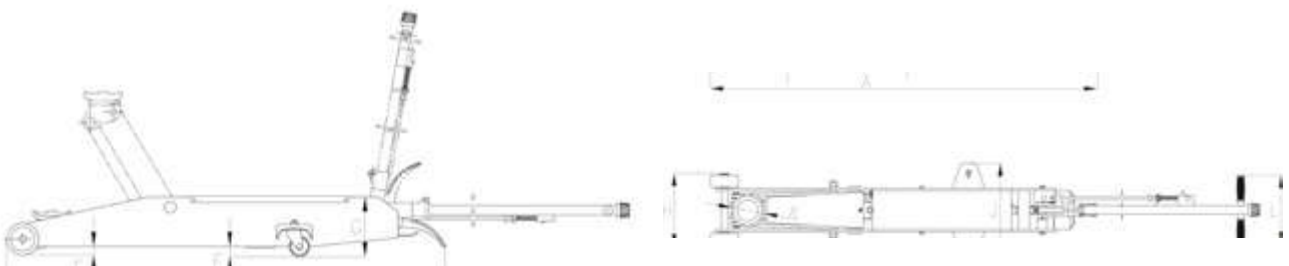

LONG CHASSIS TROLLEY JACK 10T L.1637mm

OH 5360



Bearing-mounted swivel wheels



Approach pedal

Specifications:

- anti-overloading system
- controlled lowering system

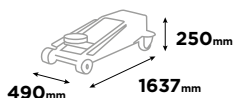

10T 10 WARRANTY



TN

FOLDABLE AIR HYDRAULIC JACK 15-30T

OH 9021

Applications: Trucks, trailers, buses

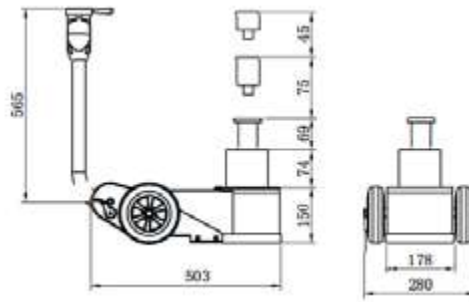

EXTENSIONS:

- 45 mm
- 75 mm



+ Special assistance Ultra compact

Specifications:

- carrying handle
- provides quick and effortless lifts
- safety overload system
- 2 stages: 30T/15T
- equipped with a speed control descent system for enhanced security
- handle: 2 sectionable parts
- foldable handle which becomes a transportation grip
- separate controls for utilization with or without the 2nd part of the handle
- angular cutting of the chassis facilitates handling

Max. T 30	↑ 413 ↓ 150 mm	→ 15T → 30T	GUM	9-12 bar	30.2 KG
--------------	-------------------	----------------	-----	----------	---------

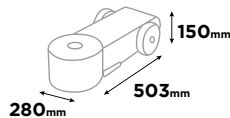

Approach pedal



Carrying handle



Metal nameplate



30T **2** WARRANTY

AIR HYDRAULIC JACK 15-30T

OH 3015N

EXTENSIONS:

- 45 mm
- 75 mm



3-position handle: 90-45-0° metal locking system



T-handle: easy positioning under the vehicle



Metal nameplate

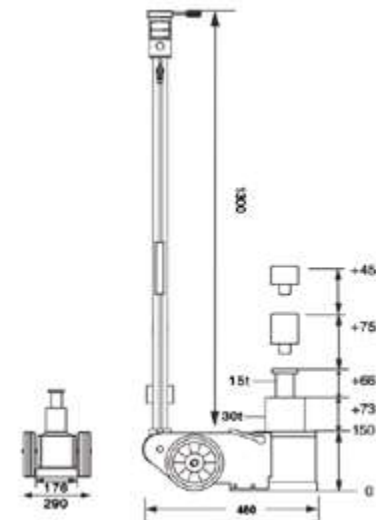

Specifications:

- provides quick and effortless lifts
- safety overload system
- equipped with a speed control descent system for enhanced security
- tempered piston for high resistance

↑ 289 ↓ 150 mm	→ 15T → 30T	GUM	9-12 bar	38 KG
-------------------	----------------	-----	----------	-------

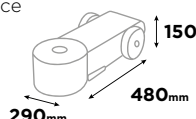

30T **2** WARRANTY



TN

MUST-HAVE

**AIR HYDRAULIC JACK
10-22-40T**

OH 9042N

Applications: Trucks, trailers, buses, agricultural machinery, civil engineering machinery.

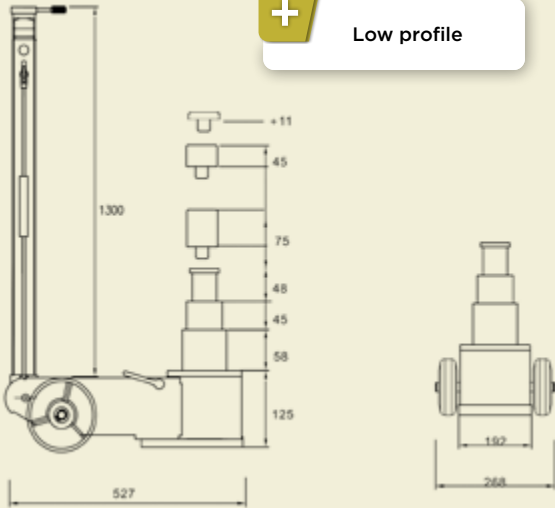

+ Low profile



3-position handle: 90-45-0° metal locking system



T-handle: easy positioning under the vehicle



Metal nameplate

EXTENSIONS:



45 mm

75 mm



Specifications:

- provides quick and effortless lifts
- safety overload system
- 3 stages: 40-22-10T
- equipped with a speed control descent system for enhanced security
- long T-handle allows you easily position your jack under the vehicle
- tempered piston for high resistance

↑ 40T	→ 10T			
↓ 125 mm	→ 22T		9 bar	36 kg
	→ 40T			

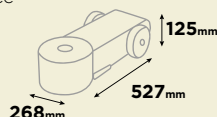

40T





AIR HYDRAULIC JACK 15-30-50T

OH 5030N

TN

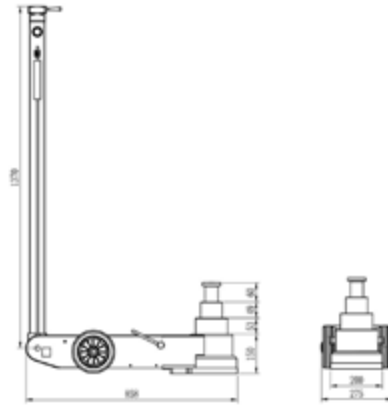

3-position handle: 90-45-0° metal locking system



T-handle: easy positioning under the vehicle



Metal nameplate

EXTENSIONS:

- 45 mm
- 75 mm



Specifications:

- provides quick and effortless lifts
- safety overload system
- equipped with a speed control descent system for enhanced security
- tempered piston for high resistance

302 mm
 150 mm
 GUM
 9 bar
 56 kg

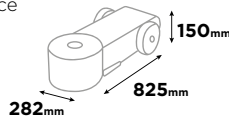

50T



HIGH LIFT AIR HYDRAULIC JACK 30T

OH 9032N

TN

Applications: Civil engineering machinery, agricultural machinery, military machinery, trains.



EXTENSIONS:

- 45 mm
- 100 mm



3-position handle: 90-45-0° metal locking system



T-handle: easy positioning under the vehicle



Metal nameplate

+ Holds full power in high rise

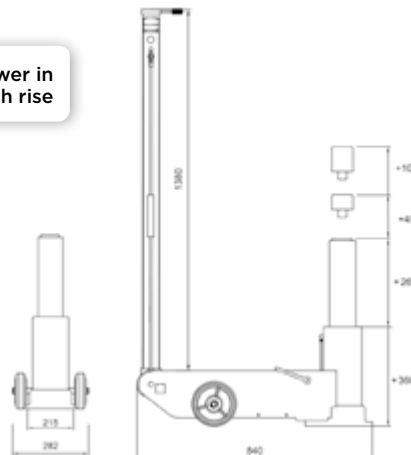

Specifications:

- provides quick and effortless lifts
- safety overload system
- equipped with a speed control descent system for enhanced security
- tempered piston for high resistance

772 mm
 360 mm
 GUM
 9 bar
 87 kg

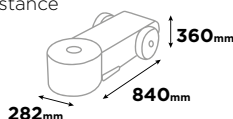

30T





PNEUMATIC JACKS

MUST-HAVE

TN

PNEUMATIC FLOOR JACK 2T-2 STAGES

OP 0209

New internal structure to increase stability, internal telescopic guide.



+ Fast and effortless lift

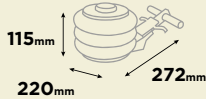

2T **2** WARRANTY

PNEUMATIC FLOOR JACK 2T-3 STAGES

TN

OP 0309

New internal structure to increase stability, internal telescopic guide.

+ Fast and effortless lift

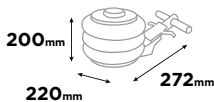

2T **2** WARRANTY

EXTENSION L.60mm

TN

SA 9131

Accessory of OP 0209/OP 0309



2 WARRANTY

EXTENSION L.80mm

TN

SA 9132

Accessory of OP 0209/OP 0309



2 WARRANTY



BOTTLE JACKS

TN

+ Robust & airtight thanks to the welded base



REF	DESIGNATION	Min. height	Max. height	Weight	Base	Max. load (T)	Transport handle	Adjustable sole
OH 4502	BOTTLE JACK 2T	181	345	2,5 kg	99x93mm	2	No	0-48
OH 4504	BOTTLE JACK 4T	193	373	3 kg	110x103mm	4	No	0-60
OH 4506	BOTTLE JACK 6T	210	415	4 kg	122x115mm	6	No	0-70
OH 4512	BOTTLE JACK 12T	230	440	6,5 kg	140x126mm	12	No	0-60
OH 4520	BOTTLE JACK 20T	242	452	9,3 kg	159x143mm	20	No	0-60
OH 4530	BOTTLE JACK 30T	275	440	12,2 kg	169x153mm	30	Yes	
OH 4550	BOTTLE JACK 50T	265	425	25 kg	210x176mm	50	Yes	

2-50T





JACK STANDS

TN



Load stabilization



Safety pin

REF	DESIGNATION	Min. height	Max. height	Weight	Max. load (T)
OM 3002BL	PAIR OF 2T JACK STANDS WITH SECURITY PIN	268mm	418mm	4,8 kg	2
OM 3030	PAIR OF 3T JACK STANDS WITH SECURITY PINS	276mm	420mm	6,4 kg	3
OM 3060	PAIR OF 6T JACK STANDS WITH SECURITY PINS	382mm	600mm	14 kg	6

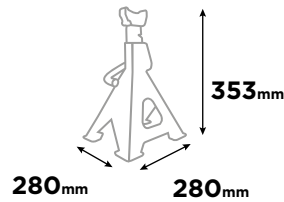

OM 3002BL

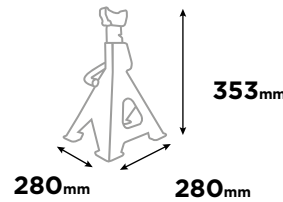

OM 3030

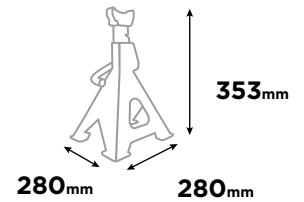

OM 3060

OM 3030 JACK STAND RUBBER PAD

EG 1157

2-6T



PAIR OF 10T JACK STANDS

OM 3100

TN

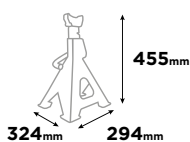

10T





PAIR OF HEIGHT ADJUSTABLE JACK STANDS 22T

TN

OM 0684

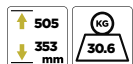
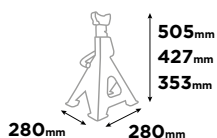

22T



PAIR TALL JACK STANDS 2T

TN

OM 2013

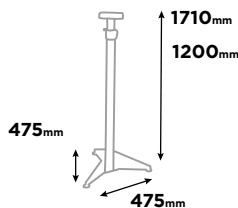

2T



JACK STANDS WITH SCREW 20T (x2)

OM 3021

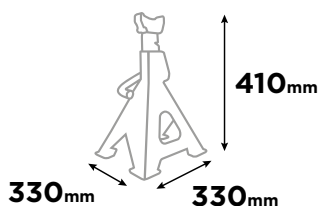
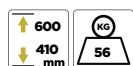

20T JACK STANDS WITH SCREW HIGH ELEVATION

OM 3023

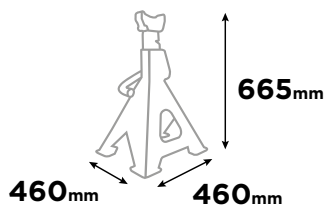

20T





PIT JACKS

TN

NOTE

Find out more about our "Clutches" range p.309



Deadman lowering control

Specifications:

- foot control
- chromed rod diameter 28mm
- overload safety
- deadman lowering control
- 4 swiveling wheels

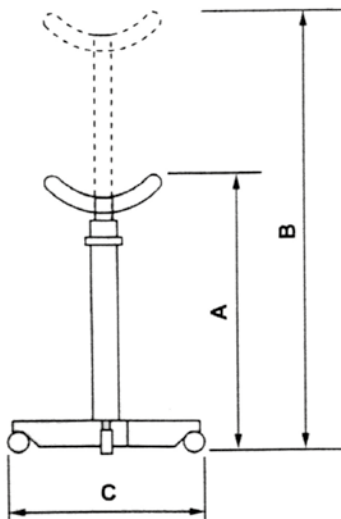

REF	DESIGNATION	Capacity	Weight	A (mm)	B (mm)	C (mm)
OH 0273	PIT JACK 300kg	300 kg	23 kg	1120	1890	800
OH 0266	PIT JACK 600kg	600 kg	34 kg	1180	2000	800
OH 0236	2 STAGE PIT JACK 800kg	800 kg	49kg	850	1870	480
OH 0235	PIT JACK 1T	1 T	37 kg	1140	1990	560
OH 0237	2 STAGE PIT JACK 1.5T	1,5 T	58 kg	880	1900	700



STRUT COMPRESSION TOOL

OM 2033



Specifications:

- maximum capacity: 600kg
- POM (polyoxymethylene) clamping jaws to avoid damaging the shock absorber
- 3 depth adjustments
- adjustable in inclination
- specific jaws in option



PENDULUM SUPPORT FOR GEARBOX

OH 0211



Specifications:

- max useful load: 200kg
- cylinder head Ø: 25mm and 30mm
- total length: 710mm
- total width: 310mm





GEARBOX SUPPORT

OH 0210



+ Increased safety

Specifications:

- maximum load capacity: 150kg
- length/width: 490mm/460mm
- forward/backward tilt: ± 35
- tilt left/right: ± 5
- weight: 12kg



SWIVEL HEAD JACKS 600kg

OH 0250

Accessory of OH 0266/OH 0263



Specifications:

- dimensions: 490x440x300mm
- tray : 360x270mm
- Tilt angle: Right: $\geq 10^\circ$
- Tilt angle: Left: $\geq 20^\circ$
- Tilt angle: Front: $\geq 24^\circ$
- Tilt angle: Rear: $\geq 19^\circ$
- Connection: $\varnothing 30$ mm
- chain length: 934mm





WORKSHOP CRANES

1T FOLDABLE CRANE

OH 0336BL

NEW

B.LINE
BUDGET SOLUTION

Specifications:

- lifting capacity: 0-2060mm
- 4 positions arm: 1000-750-500-250kg
- height feet: 185mm
- 6 rotating wheels



REF	Capacity	A (mm)	B (mm)	D (mm)	E (mm)	F (mm)	G (mm)	H (mm)
OH 0336BL	1T	1608	1435	420-1960	180	92	760	834

REF	P1 (kg)	P2 (kg)	P3 (kg)	P4 (kg)
OH 0336BL	1000	750	500	250

1T **2** WARRANTY

MUST-HAVE

1T LOW PROFILE FOLDABLE CRANE

OH 0335

+ Extra flat

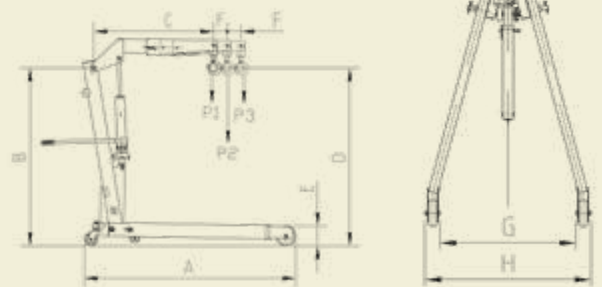
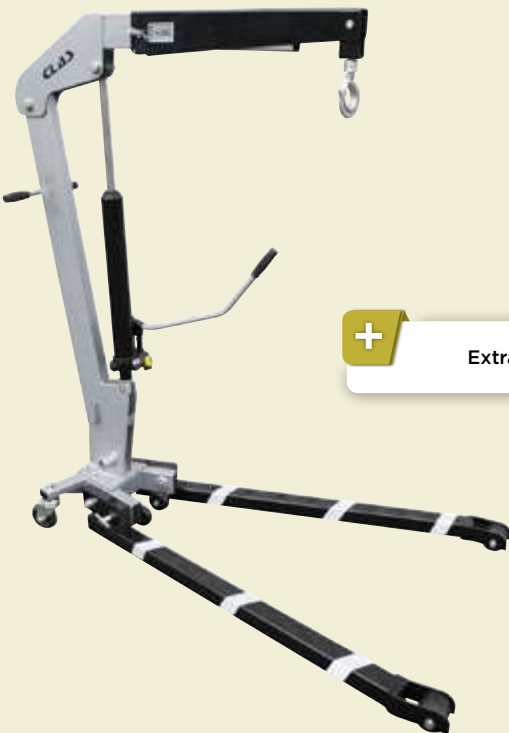

REF	Capacity	A (mm)	B (mm)	C (mm)	D1 (mm)	D2 (mm)	D3 (mm)
OH 0335	1T	1380	1600	1085	245-2330	100-2415	0-2500

REF	E (mm)	F (mm)	G (mm)	H (mm)	P1 (kg)	P2 (kg)	P3 (kg)
OH 0335	85	100	865	970	1000	750	500

Specifications:

- double acting pump
- 360° rotating pump
- deadman lowering control



1T **2** WARRANTY



MOBILE CRANE 1T

TN

OH 1001

Specifications:

- 4-position arm: 1000-900-800-700kg
- double-acting pump



+ European pallet format



1T **2** WARRANTY

DIMENSIONS

REF	Capacity	A (mm)	B (mm)	C (mm)	D (mm)	E (mm)	F (mm)	G (mm)	H (mm)	P1 (kg)	P2 (kg)	P3 (kg)	P4 (kg)	Weight
OH 1001	1T	1392	1570	1060	1150	120	100	835	963	1000	900	800	700	103 kg
OH 0338	2T	1977	1977	1290	0-2705	205	150	994	1158	2000	1700	1500	-	147 kg

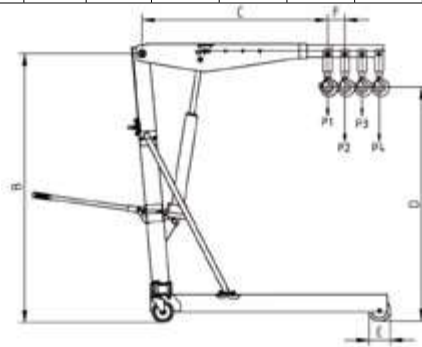
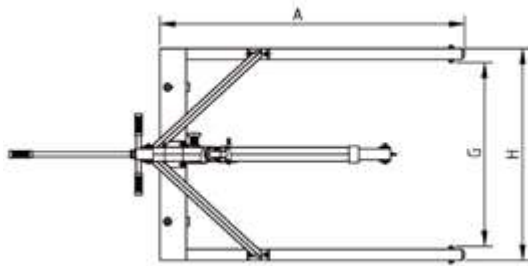

2T FOLDABLE CRANE

TN

OH 0338



360° rotating pump



Specifications:

- deadman lowering control
- double acting pump
- 360° rotating pump

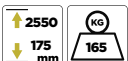

2T **2** WARRANTY

LOAD BALANCER 680kg

TN

OH 0238



Specifications:

- length: 400mm
- usable stroke: 350mm
- height: 50mm
- thickness: 12mm
- worm Ø: 15.8mm



680KG **2** WARRANTY

DRUM GRIP 350kg

TN

OH 0009



Specifications:

- for plastic and metal drums up to 208kg
- max. opening 580mm



350KG **2** WARRANTY





LIFT PADS & BLOCKS

Hardness 85° SHORE
Sold by unit

Detailed drawings and
dimensions on [clas.com](https://www.clas.com)

	DESIGNATION	REF	Ø exterior	
	TESLA PAD 3 Ø76/26 x h.51/25	EG 1153	76 mm	

Sold by unit

	DESIGNATION	REF	
 NEW	UNIVERSAL REVERSIBLE RUBBER PAD JACK	EG 1155	
 NEW	UNIVERSAL REVERSIBLE RUBBER PAD JACK	EG 1156	
 NEW	OM 3030 JACK STAND RUBBER PAD	EG 1157	

Sold in multiples of 4 only

	DESIGNATION	REF	
 NEW	PAD FIAT 500E/500X/JEEP RENEGADE Ø100 X H.55	EG 1154	





LIFTING TABLES

REF	OH 1300	OH 1301	OH 1500
Platform length min/max	1010mm	1355/1520mm	1440mm/1640mm
Dimensions	575x1140x460	1680x780x1000mm	800x1000mm
Min/max height	440/1575mm	2730/065mm	1800mm
Climbing time	Depends on load supported	60 sec	70 to 110 sec depending on load
Lowering time		20 sec	17 sec
Wheels	2 braked swivel wheels 150 mm 2 fixed wheel 150 mm	4 130 mm braked swivel wheels	2 fixed and 2 swivel with brakes
Capacity	500 kg	1000kg	1500kg
Budget	€	€€	€€€
Energy	MANUAL	HYDROPNEUMATIC	HYDROPNEUMATIC
Weight	160kg	385kg	430kg
Descent safety	cable	cable	pneumatic

500kg HYDRAULIC LIFT TABLE

OH 1300

Ideal for handling parts (boxes, engines, axles, batteries...).

**NOTE**

Pads and shims see p.147



2 fixed and 2 swivel wheels with protective housings and brakes



Hydraulic lift control via foot pedal

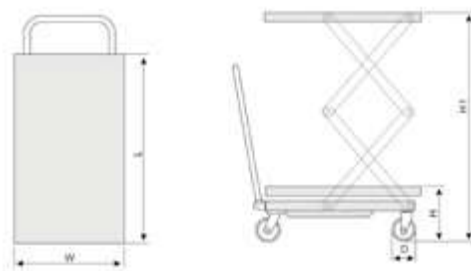

L (mm)	W (mm)	D (mm)	H (mm)	H1 (mm)
1010	520	150	440	1575

Specifications:

- pedal hydraulic lift command
- dead man-type descent command
- tray dimensions 1010x520mm
- 2 fixed wheels and 2 swiveling wheels with protective casing and brakes

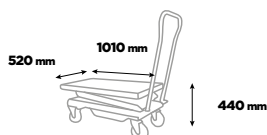
**500KG**



LIFTING TABLE 1000kg FOR EV BATTERY AND HEAVY ORGANS

TE

OH 1301



This table is specially designed for the removal and re-installation of heavy components with a maximum load of 1T (electric vehicle battery and/or drive train). Versatile, it will be able to adapt to all your needs thanks to its many adjustments and its optional supports on request.



NOTE

Lift table technical information p.433

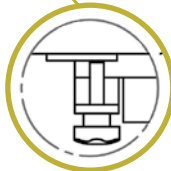

Tilt adjustment

1T

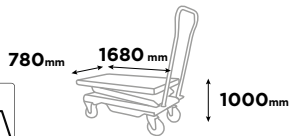

LIFTING TABLE 1500kg FOR EV BATTERY AND HEAVY ORGANS

TE

OH 1500



High load 1500Kg
High precision of settings



Specifications:

- h. min.: 580mm
- h. max.: 1800mm
- max. height on safety catches: 1740mm
- rise time (depending on the load) : 70-110 sec (example: 73 seconds with a load of 457 kg)
- lowering time (depending on the load): +- 30 sec (example: 34 seconds with a load of 457 kg)
- platform length: 1400-1600mm

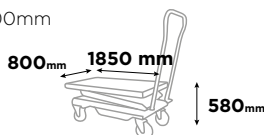

1.5T





MUST-HAVE

HYDROPNEUMATIC MOBILE LIFTING COLUMN 1500kg

OH 9150

+ Allows the vehicle to be lifted in less than a minute.



- Specifications:**
- 2 swivel wheels to facilitate handling
 - safety pin: 5 secure heights
 - lifting by the wheel or the car body
 - mobile and fast

Supplied with:

- SA9151: lifting under the wheel
Max. working height: 735mm
Min. height: 100mm
Wheel diameter from 480 to 730mm

- SA9152: lifting under the car body
Max. working height: 835mm
Min. height: 140mm



1.5T





PRESS SHOP

HYDRAULIC PRESS 20T

OH 0921

Specifications:

- 1 speed hydraulic pump
- chrome piston with adjusting screw
- polycarbonate protection to protect the operator from splinters
- table height adjustable 12 positions
- winch-assisted up and down movement of the table
- 2 oversized pins to hold the table in place
- 159x88x40mm sliding drip tray
- large manometer
- reversible V-shaped support block, including punch kit and protective polycarbonate



Polycarbonate operator protection included on all models



+ Winch-assisted table



NOTE

Find out more about our "Bearings" range p.300



DUAL-CONTROL HYDRAULIC PRESS 30T SLIDING CYLINDER

OH 0931

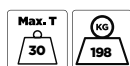

DUAL-CONTROL HYDRAULIC PRESS 50T SLIDING CYLINDER

OH 0951

Specifications:

- hydraulic pump
- manual override or hydropneumatic pedal
- chrome piston with adjusting screw
- sliding cylinder jack with handle and rating scale
- polycarbonate protection to protect the operator from splinters
- table height adjustable 12 positions
- winch-assisted up and down movement of the table
- 2 oversized pins to hold the table in place
- 226x136x55mm sliding drip tray
- large manometer
- reversible V-shaped support block, including punch kit and protective polycarbonate

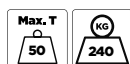

20T





TN

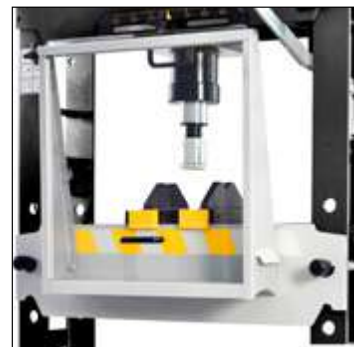

+ Protective polycarbonate screen to shield the operator

HYDROPNEUMATIC PRESS 100T

OH 0910

Specifications:

- hydraulic pump
- manual control or hydropneumatic pedal (dual pedal up and down)
- chrome plated piston with adjustment screw
- sliding cylinder with handle and positioning scale
- polycarbonate screen protection (5,5 cm) to protect the operator against possible splinters
- table height adjustable in 12 positions
- table raising/lowering assisted by winch
- table holding by 2 oversized pins
- large pressure gauge
- reversible V-shaped support block and plexiglass set included.



TN



PRESS ACCESSORIES

REF	DESIGNATION	Compatibility	
OH 0821	20T PUNCHER TOOLS	Spare part of OH 0820/OH 0921	
OH 0831	30T PUNCHER TOOLS	Spare part of OH 0830/OH 0430/OH 0931	
OH 0851	50T PUNCHER TOOLS	Spare part of OH 0850/OH 0951	
OH 0810	100T PUNCHER TOOLS	Accessory of OH 0910	
OH 0833	UNIVERSAL 20-30T PRESS SUPPORT STRUCTURE	Accessory of OH 0820/OH 0921/OH 0931/OH 0430/OH 0830/OH 0920/OH 0930	

BEARING FORK SEAL INSTALLATION/EXTRACTION KIT

OM 3419

Contents:

- 50 kits Ø18 to Ø74mm
- 1 cup support: 18mm
- 1 extender: 220mm



HAND TOOLS



TOOL CABINETS P.154



PLIERS P.187



TOOL CASES P.166



HAMMERING TOOLS P.189



WRENCHES P.168



TORQUE WRENCHS P.192



SOCKET & RATCHET P.170



MEASUREMENT & CONTROL P.195



SCREWING P.182



CUTTER & SCRAPER P.196



EQUIPPED TOOL CABINETS

TN

7 DRAWER ROLLER CABINET + 214 TOOLS

EG 1100BL

B.LINE
BUDGET SOLUTION

NEW



Contents:

- 7 drawer roller cabinet
- 1 screwdriver insert (15pcs)
- 7 torx screwdrivers (mm): T9x75-T15x100-T20x100-T25x100-T27x100-T30x100-T40x150
- 4 phillips screwdrivers (mm): PH2x38-PH2x100-PH3x150-PH1x75
- 4 pozidrive screwdrivers (mm): SL6x38-SL5x75-SL6x100-SL6.5x150
- 1 pliers and hammer insert (13pcs)
- 1 internal straight circlip pliers
- 1 internal circlip pliers, curved nose
- 1 straight external circlip pliers
- 1 6" bending pliers
- 1 6" diagonal pliers
- 1 combination pliers 8"
- 1 long nose pliers 6"
- 1 10" water pump pliers
- 1 general-purpose hammer 300g
- 4 scissors (mm): 3x150, 5x150, 6x150, 8x150
- 1 socket and ratchet insert (64pcs)
- 17 sockets 1/2" DR (mm): 10-11-12-13-14-15-17-18-19-21-22-23-24-27-30-32
- 15 sockets 3/8" DR (mm): 8-9-10-11-12-13-14-15-16-17-18-19-21-22-24
- 13 sockets 1/4" DR (mm): 4-4.5-5-5.5-6-7-8-9-10-11-12-13-14
- 3 ratchet handles: 1/4", 1/2", 3/8"
- 3 1/2" sockets (mm): 17-19-21
- 1 1/4" cone
- 3 universal joints: 1/4", 1/2", 3/8
- 3 sliding bars: 1/4", 1/2", 3/8
- 2 1/2" extension bars: 5" and 10
- 2 extension bars 3/8": 6" and 3
- 2 x 1/4" extension bars: 4" and 2
- 1 bit insert (102pcs)
- 48 bits 1/4" 35mm: T8-9-10-15-20-27-30-40 / TT8-9-10-15-20-25-27-30-40 / PH0-1-2-3 SL4- 5.5-6.5-7 / PZO-1-2-3 M7-8-10-12 / H3-4-5-6-7-8 / TS10-15-20-25-27-30-40-45-50
- 24 bits 30 mm: SL8-10-12 / T40-45-50-55-60-70 / PZ3-4 / PH3-4 H7-8-10-12-14 / TT40-45-50-55-60-70
- 6 pieces 1/2" short bits 55 mm: M16-H24-H22-H19-H17-H14
- 22 long sockets 1/2" (mm): T80x100, M16x100, M9x100, MP9x100
- T40x140, T45x140, T50x140, T55x140, T60x140, T70x140, M10x140, M12x140
- M14x140, MP10x140, H10x140, H11x140, H13x140
- H5x160, MP8x250, MP7x240, H7x240, H30x300
- 1 1/2" coupling
- 1 1/2" M15 impact socket
- 1 wrench insert (20pcs)
- 12 ratchet combination wrenches (mm): 8-9-10-11-12-13-14-15-16-17-19-22
- 8 double offset ring wrenches (mm): 6x7-8x9-10x11-12x13-14x15-16x17-18x19-20x22

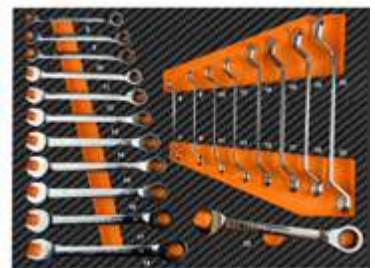
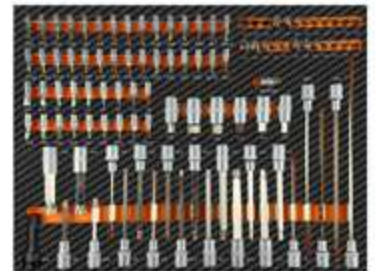



TN

6 INSERTS 2 DRAWERS 154 TOOL KIT

EG 4154



SCREWDRIVER INSERT (8 PCS)

OS 1000



COMBINATION WRENCH INSERT 6-24mm (17 PCS)

OS 4100



1/2" RATCHET INSERT (23 PCS)

OS 3000



PLIER INSERT (4PCS)

OS 5000



SPECIAL BIT INSERT (43PCS)

OS 6000



RATCHET INSERT 1/4" (59PCS)

OS 3200



154 TOOLS ROLLER CABINET

Available with 6, 7 or 8 drawers.

6 DRAWERS ROLLER CABINET

EG 0088



7 DRAWERS ROLLER CABINET

EG 0087



8-DRAWER ROLLER CABINET

EG 0098

	6 drawers	7 drawers	8 drawers
Roller cabinet + 154 tools	EG 6154	EG 7154	EG 9154





TOOL CABINETS • EQUIPPED TOOL CABINETS

← FIND THE COMPLETE RANGE OF **EQUIPPED TOOL CABINETS** HERE

TN

9 INSERTS 3 DRAWERS 172 TOOL KIT

EG 4205



SCREWDRIVER INSERT (8 PCS)

OS 1000



COMBINATION WRENCH INSERT 6-24mm (17 PCS)

OS 4100



1/2" RATCHET INSERT (23 PCS)

OS 3000



PLIER INSERT (4PCS)

OS 5000



SPECIAL BIT INSERT (43PCS)

OS 6000



RATCHET INSERT 1/4" (59PCS)

OS 3200



7 PCS TORX SCREWDRIVER INSERT T10-40

OS 1100



HEX T-HANDLE WRENCH INSERT 3-10mm (7 PCS)

OS 2000



4PCS CIRCLIP PLIER INSERT 7" INSIDE-OUTSIDE

OS 5200



172 TOOLS ROLLER CABINET

Available with 6, 7 or 8 drawers.

7 DRAWERS ROLLER CABINET

EG 0087

6 DRAWERS ROLLER CABINET

EG 0088



	6 drawers	7 drawers	8 drawers
Roller cabinet + 172 tools	EG 6205	EG 7205	EG 9205

8-DRAWER ROLLER CABINET

EG 0098



TN

11 INSERTS 4 DRAWERS 214 TOOL KIT

EG 4213



SCREWDRIVER INSERT (8 PCS)

OS 1000



COMBINATION WRENCH INSERT 6-24mm (17 PCS)

OS 4100



1/2" RATCHET INSERT (23 PCS)

OS 3000



PLIER INSERT (4PCS)

OS 5000



SPECIAL BIT INSERT (43PCS)

OS 6000



RATCHET INSERT 1/4" (59PCS)

OS 3200



HEX T-HANDLE WRENCH INSERT 3-10mm (7 PCS)

OS 2000



3/8" RATCHET INSERT 21 PCS

OS 3600



HEX SOCKET SPANNER INSERT 20-24mm (5 PCS)

OS 5499



7 PCS T-HANDLE WRENCH INSERT TORX T10-T40

OS 2100



7 PCS T-HANDLE WRENCH INSERT TORX T10-T40

OS 2100

IMPACT SOCKET KIT 10-19mm 3/8" (8 PCS)

OS 3300



214 TOOLS ROLLER CABINET

Available with 6, 7 or 8 drawers.



6 DRAWERS ROLLER CABINET
EG 0088



7 DRAWERS ROLLER CABINET
EG 0087



8-DRAWER ROLLER CABINET
EG 0098

	6 drawers	7 drawers	8 drawers
Roller cabinet + 214 tools	EG 6245	EG 7245	EG 9245



4 DRAWERS + 235 HGV TOOL DOOR ROLLER CABINET

EG 4247

Cabinet "Made in France".

Wide and sturdy, it offers a larger work surface and a total load capacity of 900kg.

Perforated on both sides, the cabinet is fully accessorizable (workshop bin, hand towel dispenser, etc...)

Its side lock located under the handle protects the key during handling.



OS 1000



OS 1100



OS 2000



OS 2100



OS 3200



OS 4100

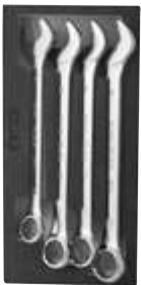

OS 4200



OS 5399



OS 5000



OS 5200



OS 6000



OS 0850



OS 3000



OS 5499



OS 3450



OM 0800



OS 5024



OS 3500



EG 0097

+ 900 Kg load capacity

- OS2100: 1 x 7 pcs t-handle wrench insert torx t10-t40
- OS2000: 1 x hex t-handle wrench insert 3-10mm (7 pcs)
- OS1000: 1 x screwdriver insert (8 pcs)
- OS4100: 1 x combination wrench insert 6-24mm (17 pcs)
- OS5399: 1 x hex. socket spanner insert 8-19mm (12 pcs)
- OS5499: 1 x hex socket spanner insert 20-24mm (5 pcs)
- OS3000: 1 x 1/2" ratchet insert (23 pcs)
- OS5000: 1 x plier insert (4pcs)
- OS6000: 1 x special bit insert (43pcs)
- OS4200: 1 x 4 piece combination wrench insert 27-32mm
- OS1100: 1 x 7 pcs torx screwdriver insert t10-40
- OS3200: 1 x ratchet insert 1/4" (59pcs)
- OS5200: 1 x 4pcs circlip plier insert 7" inside-outside
- OS3450: 1 x ratchet+hex socket set 3/4" d. (14 pcs)
- OS3500: 1 x hex impact socket kit 24-50mm 1" (9 pcs)
- OS5024: 1 x 24" aluminum claw wrench
- EG0097: 1 x 4 drawers + 1 door roller cabinet hgv
- SA088: 1 x hammering insert
- OM0801: 1 x 6 pin driver set with base
- OM0803: 1 x automatic punch
- OM0160: 1 x rivoir hammer composite handle 1000gr
- OM0170: 1 x dead blow hammer with interchangeable tip 32mm
- OM0800: 1 x extra flat splitting chisel





BODY REPAIR ROLLER CABINET 190 TOOLS

EG 8888



OS 1000



OS 1100



OS 3000



OS 2000



OS 4100



OS 3200



OS 0850



OS 5000



OC 6081



OC 6080



EG 0087

- EG0087: 1 x 7 drawers roller cabinet
- OC0811: 1 x hammer + block set (7 pcs)
- OM0749BL: 1 x riveting pliers
- SA0115: 1 x plastic chisel
- OC0033: 1 x trim clip plier
- OM8081: 1 x lock grip plier 190mm
- OM8080: 1 x lock grip pliers 225mm
- OP1510: 1 x 1/4"-3/8" d. mini ratchet wrench kit
- OP1203: 1 x mini die grinder ø6mm 25,000rpm
- OM0643: 1 x 5 carbide rotary rasps box
- EG0680: 1 x 25pcs drill set hss cobalt 5%
- EG8009: 1 x dispenser/hand towel roll stand for drawers
- EG8001: 1 x metal workshop waste for drawer
- OS3200: 1 x ratchet insert 1/4" (59pcs)
- OS4100: 1 x combination wrench insert 6-24mm (17 pcs)
- OS3000: 1 x 1/2" ratchet insert (23 pcs)
- OS5000: 1 x plier insert (4pcs)
- OS1000: 1 x screwdriver insert (8 pcs)
- OS1100: 1 x 7 pcs torx screwdriver insert t10-40
- OS2000: 1 x hex t-handle wrench insert 3-10mm (7 pcs)
- OC1700BL: 1 x windscreen wiper remover
- OC0302: 1 x scraper and utility knife set
- OC8078: 1 x 5 pcs nylon trim removal set
- SA0881: 1 x hammering insert
- OM0801: 1 x 6 pin driver set with base
- OM0803: 1 x automatic punch
- OM0160: 1 x rivoir hammer composite handle 1000gr
- OM0170: 1 x dead blow hammer with interchangeable tip 32mm
- OM0800: 1 x extra flat splitting chisel
- OP1451: 1 x ø13mm reversible drill
- OC6081: 1 x wide bodywork spoon
- OC6080: 1 x long bodywork spoon
- OP0099: 1 x straight blowgun pen





TOOL CABINETS

6 DRAWERS ROLLER CABINET

TN

EG 0088



+ Drawers open fully

- Specifications:**
- total size: W.688xD.459xH.858mm
 - steel thickness of body: 0.8mm
 - steel thickness of drawers: 0.6 to 0.8mm
 - 3 drawers 75mm
 - 3 drawers 154mm
 - casters: PP 5x2: 2 fixed, 2 swivel with side brakes



8-DRAWER ROLLER CABINET

TN

EG 0098



- Specifications:**
- dimensions: 688x459x858mm
 - thickness of steel body: 0,8mm
 - steel thickness of drawers: 0,6 to 0,8mm
 - 7 drawers: 75mm
 - 1 drawer: 154mm
 - wheels: PP, 2 fixed, 2 swivel with lateral brakes
 - load capacity per drawer: 45kg
 - tray load: 200kg





7 DRAWERS ROLLER CABINET

EG 0087

+ 400kg load



Supplied with a wooden plate and 8mm thick foam worktop

Specifications:

- overall dimensions: 688x459x1035mm (height without wheels 858mm)
- 5x75mm high drawers (580x400x61mm)
- 2 drawers H.154mm (580x400x141mm)
- full extension ball bearing slides
- lockable drawers
- ABS drawer handles
- 2 fixed casters Ø125mm
- 2 swiveling casters with side brakes Ø125mm
- locks with a key (2 keys provided)
- 2.5mm of EVA foam in each drawer
- permissible load in each drawer: 45kg
- permissible load on the tray: 300kg
- total permissible load: 400kg
- empty weight: 68kg



3 TRAY ROLLER CABINET

EG 0083



Specifications:

- overall dimensions: 766x415x840mm
- tray dimensions: 760x410x60mm
- 2 fixed casters Ø100mm
- 2 swiveling casters Ø100mm with brakes
- 2.5mm thick EVA foam tray protection
- admissible load per shelf: 30kg
- total admissible load: 90kg





4 DRAWERS + 1 DOOR ROLLER CABINET HGV

EG 0097

Cabinet "Made in France".

Wide and sturdy, it offers a larger work surface and a total load capacity of 900kg.

Perforated on both sides, the cabinet is fully accessorizable (workshop bin, hand towel dispenser, etc...)

Its side lock located under the handle protects the key during handling.

+ Made in France
Empty weight: 61kg



Specifications:

- dimensions: L.989xW.450xH.983mm (height without wheels 831mm)
- 100% drawer opening
- 4 drawers H.75mm inside 774x440mm
- 1 door H.386mm inside 970x428mm
- aluminum plate
- slides equipped with ball bearings
- aBS drawer handles
- side lock

- key lock (2 keys provided)
- wheels on sealed bearing
- 2 fixed wheels Ø125mm
- 2 steering castors Ø125mm which 1 with double brake (rotation + pivot)
- permissible load per drawer: 45kg
- total load-carrying capacity: 900kg
- weight: 61kg



1 DRAWER TOOLBOX-FRIDGE 50l

AP 0080

Specifications:

- total size: W.438xD.539xH.672mm
- 1 refrigerated compartment 50l + 1 drawer
- adjustable refrigerator
- 4 wheels: 2 fixed, 2 swivel

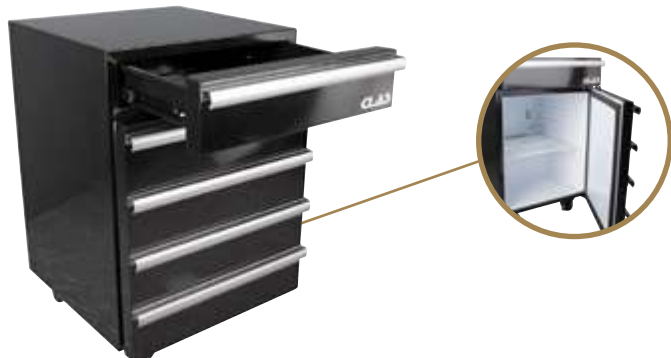



20 MAGNETIC HOOKS SET

EG 8008



MAGNETIC TRAY

EG 8007



4PCS MAGNETIC TOOL TRAY SET

EG 8004



MAGNETIC TOOL HOLDER

EG 0070



MAGNETIC SPRAY CAN AND SCREWDRIVER HOLDER

EG 8006



METAL WORKSHOP WASTE FOR DRAWER

EG 8001



DISPENSER/HAND TOWEL ROLL STAND FOR DRAWERS

EG 8009



Hooks available on clas.com





TOOL SETS

TN



SCREWDRIVER INSERT (8 PCS)

OS 1000



7 PCS TORX SCREWDRIVER INSERT T10-40

OS 1100



HEX T-HANDLE WRENCH INSERT 3-10mm (7 PCS)

OS 2000



7 PCS T-HANDLE WRENCH INSERT TORX T10-T40

OS 2100



1/2" RATCHET INSERT (23 PCS)

OS 3000



RATCHET INSERT 1/4" (59PCS)

OS 3200



3/8" RATCHET INSERT 21 PCS

OS 3600



ADJUSTABLE RATCHETING COMBINATION WRENCH INSERT 8-19mm (12PCS)

OS 4020



COMBINATION WRENCH INSERT 6-24mm (17 PCS)

OS 4100



4 PIECE COMBINATION WRENCH INSERT 27-32mm

OS 4200



HEX. SOCKET SPANNER INSERT 8-19mm (12 PCS)

OS 5399



HEX SOCKET SPANNER INSERT 20-24mm (5 PCS)

OS 5499





TN



Insert dimensions:
390x190x35mm



**PLIER INSERT
(4PCS)**

OS 5000



**4PCS CIRCLIP PLIER
INSERT 7" INSIDE-
OUTSIDE**

OS 5200



**SPECIAL BIT INSERT
(43PCS)**

OS 6000

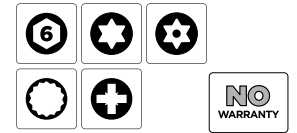

**FLARE NUT
WRENCH INSERT
8-19mm (6 PCS)**

OS 0070



**MEASURING
TOOLS INSERT
(6PCS)**

AC 0000



**HAMMERING INSERT
(10 PCS)**

OS 0850



NOTE

Detailed insert compositions
on the following pages



FOAM STORAGE TRAY

EG 0080

Ideal for mechanical parts, screws or tools storage. Thanks to its EVA foam design, it prevents surfaces from being scratched. The "1/3 drawers" format facilitates positioning in roller drawers cabinet and optimizes space as much as possible.



TN





TOOL CASES

← FIND THE COMPLETE RANGE OF TOOL CASES HERE



TOOL CASES

PRECISION RATCHET+SCREWDRIVER SET (78PCS)

TN

OS 1040BL

Compact case for hard-to-reach jobs, ideal for adding to a repair toolbox.

NEW



Precision pliers

B.LINE
BUDGET SOLUTION

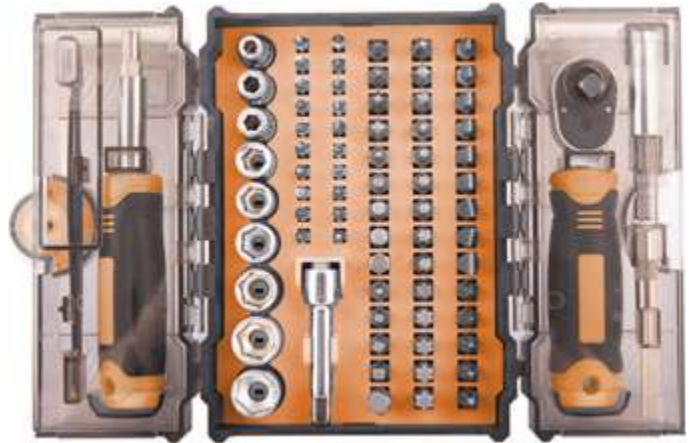

Contents:

- 1 reversible ratchet 1/4" 6.35
- 1 bit-holder screwdriver
- 1 extension
- 1 magnetic holder
- 1 precision holder
- 1 precision plier
- 41 bits 6.35x25mm
- 1 adapter 25mm
- 1 magnetic precision tip adapter
- 20 precision bits 4x28mm
- 9 1/4 sockets: 4-5-6-7-8-9-10-11-12mm



Reversible ratchet



1/4"-1/2" TOOL SET (108PCS)

TN

OS 3050BL

Intervention composition for 1/4" and 1/2" mechanical and industrial applications.

B.LINE
BUDGET SOLUTION





1/4"-3/8"-1/2" TOOL SET (172PCS)

OS 3280BL

Intervention solutions for mechanical and industrial applications 1/4", 3/8" and 1/2".

B.LINE
BUDGET SOLUTION

NEW

**Contents:**

- 1 black plastic case
- 7 Allen keys: 1.25-1.5-2-2.5-3-4-5mm
- 1 1/2"-3/8" reducer
- 3 1/2"-3/8"-1/4" cardan sockets
- 1 rotating handle: 150mm
- 3 connections: 1/4 "x1/4"-1/2 "x5/16"-3/8 "x5/16"

1/2" composition :

- 1 1/2" ratchet 72 teeth
- 17 hexagon sockets: 10-11-12-13-14-15-16-17-18-19-20-21-22-24-27-30-32mm
- 5 long hexagon sockets: 16-17-18-19-22mm
- 2 Torx E sockets: E20-E24
- 2 extension sockets 1/2": 125-250mm
- 2 spark plug sockets 1/2": 16-21mm

Composition 3/8" :

- 1 ratchet 72 teeth 3/8"
- 10 hexagon sockets: 10-11-12-13-14-15-16-17-18-19mm
- 6 long hexagon sockets: 10-11-12-13-14-15mm
- 6 Torx E sockets: E10-E11-E12-E14-E16-E18

- 1 extension 3/8": 150mm
- 1 spark plug socket 3/8": 18mm

1/4" composition :

- 1 72-tooth 1/4" ratchet
- 13 hexagon sockets: 4-4.5-5-5.5-6-7-8-9-10-11-12-13-14mm
- 7 long hexagon sockets: 4-5-6-7-8-9-10mm
- 5 Torx E sockets: E4-E5-E6-E7-E8
- 1 sliding handle 1/4": 115mm
- 2 risers 1/4": 50-100mm
- 8 x 1/4" torx bit sockets: T8-T9-T10-T15-T20-T25-T27-T30
- 8 sockets for drilled tort 1/4" : T8-T9-T10-T15-T20-T25-T27-T30
- 3 Philipps bit sockets 1/4": PH0-PH1-PH2
- 3 Pozidrive bit sockets 1/4": PZ0-PZ1-PZ2
- 4 sockets slot 1/4" : SL4-SL5.5-SL6.5-SL7mm
- 4 hexagon socket bits 1/4": H3-H4-H5-H6mm
- 20 bits 25mm: Ø6.25mm
- 24 bits 30mm: Ø8mm





TOOL SETS

TN

COMBINATION WRENCH INSERT 6-24mm (17 PCS)

OS 4100



4 PIECE COMBINATION WRENCH INSERT 27-32mm

OS 4200

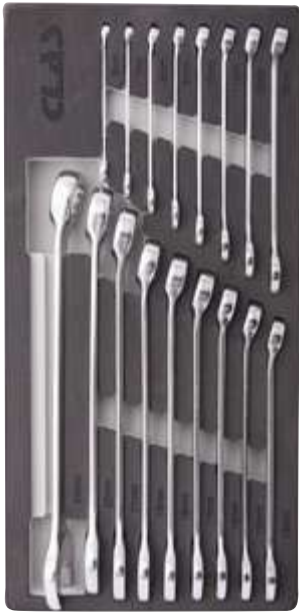

Specifications:

- format: 1/3 drawer
- insert dimensions: 390x185x50mm
- finish: micro satin
- material: chrome vanadium
- angle: 13°
- DIN ISO 3113

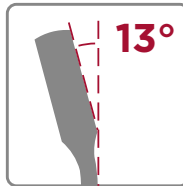

Retail components available on clas.com



ADJUSTABLE RATCHETING COMBINATION WRENCH INSERT 8-19mm (12PCS)

TN

OS 4020

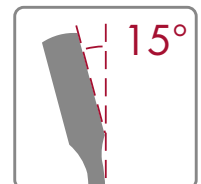

Specifications:

- format 1/3 drawer
- insert dimensions: 390x185x50mm
- finish: micro satin
- material: chrome vanadium
- angle: 15°
- DIN ISO 691
- DIN ISO 1711-1





CLAW WRENCHES

HEX SOCKET SPANNER
INSERT 20-24mm (5 PCS)

OS 5499



HEX. SOCKET SPANNER
INSERT 8-19mm (12 PCS)

OS 5399



Specifications:

- Format: 1/3 drawer
- Finish: micro satin
- Material: chrome vanadium



TN



FLARE NUT WRENCH
INSERT 8-19mm (6 PCS)

OS 0070



Specifications:

- 13° angle
- hex socket
- CRV steel



TN

14" ALUMINUM CLAW WRENCH

OS 5014



Specifications:

- length: 320mm
- opening: 50mm
- weight: 920g



24" ALUMINUM
CLAW WRENCH

OS 5024

Specifications:

- length: 607mm
- opening: 76mm
- weight: 2400g

TN

12" ADJUSTABLE CRV WRENCH

OS 0060



Specifications:

- opening 34mm
- length 300mm
- CRV





SOCKET & RATCHET • 1/4" SOCKET & RATCHET

← FIND THE COMPLETE RANGE OF 1/4" SOCKET & RATCHET HERE



1/4" SOCKET & RATCHET

1/4" TORX PLUS SOCKETS EP 6-7-8-10-11-12 L.25mm

OM 7019

Specially designed for Torx Plus indentations. More resistant to torsion, increased service life compared with classic Torx models.

Nissan, Renault, cylinder head...
Not compatible with Torx Classique indentations



+ Torx Plus = improved grip/reduced wear to the indentation



TN

SET 7 SOCKETS TS TIPS 1/4" D. TS10-TS15-TS20-TS25-TS27-TS30-TS40

OM 7006

These 5 star bits are for brands: Renault, Peugeot, Mercedes, Rover and diesel injection pumps.



TN

BIT SET TS PLUS - TORX PLUS 1/4"-3/8" (23 PCS)

OM 0645

Not compatible with Torx Classic indentations



+ Torx Plus = improved grip and reduced wear to the indentation



TN



RATCHET INSERT 1/4" (59PCS)

OS 3200

Specifications:

- Format: 1/3 drawer
- Insert dimensions: 390x185x50mm
- DIN ISO 2725-3

32 PCS SCREWDRIVER BIT 1/4" SET

OS 3230

Spare part of OS 3200



SPHERICAL HEX KEY SET H1,5-10 (9 PCS)

OS 3220

Spare part of OS 3200/OS 3270

Material: SVCM steel



1/4" RATCHET 72 TEETH

OS 3211

Spare part of OS 3200/OS 3250/OS 3050/OS 3055



TN



PRECISION RATCHET+SCREWDRIVER SET (78PCS)

OS 1040BL

Compact case for hard-to-reach jobs, ideal for adding to a repair toolbox.

B.LINE
 BUDGET SOLUTION

NEW

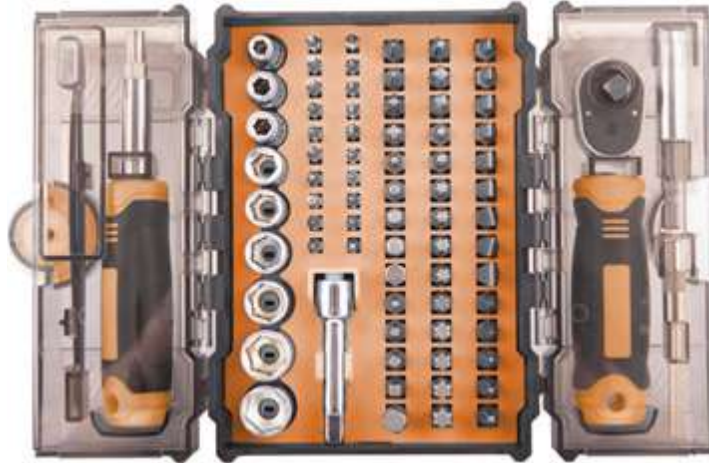

Contents:

- 1 reversible ratchet 1/4" 6.35
- 1 bit-holder screwdriver
- 1 extension
- 1 magnetic holder
- 1 precision holder
- 1 precision plier
- 41 bits 6.35x25mm
- 1 adapter 25mm
- 1 magnetic precision tip adapter
- 20 precision bits 4x28mm
- 9 1/4 sockets: 4-5-6-7-8-9-10-11-12mm



1/4"

MORE DETAILS

6.3

6-SIDED SOCKETS



SIZE	SHORT	LONG	REF
4mm	•		OS 3201
4.5mm	•		OS 3202
5mm		•	OS 3203
5.5mm	•		OS 3204
6mm	•		OS 3205
		•	OS 3206
7mm	•		OS 3207
		•	OS 3208
8mm	•		OS 3209
		•	OS 3210
9mm	•		OS 3259
		•	OS 3260
10mm	•		OS 3261
		•	OS 3262
11mm	•		OS 3263
		•	OS 3264
12mm	•		OS 3265
		•	OS 3266
13mm	•		OS 3267
		•	OS 3268
14mm	•		OS 3269

TORX+ SOCKETS



SIZE	SHORT	LONG	REF
EP6	•		SA 7086
EP7	•		SA 7087
EP8	•		SA 7088
EP10	•		SA 7089
EP11	•		SA 7090
EP12	•		SA 7091

SOCKETS BITS TS



SIZE	SHORT	LONG	REF
TS10	37mm		SA 0459
TS15	37mm		SA 0460
TS20	37mm		SA 0461
TS25	37mm		SA 0462
TS27	37mm		SA 0463
TS30	37mm		SA 0464
TS40	37mm		SA 0465
TS45	37mm		SA 0432
TS50	37mm		SA 0433



3/8" SOCKET & RATCHET

IMPACT SOCKET KIT 10-19mm 3/8" (8 PCS)

TN

OS 3300



DIN ISO 2725-3

Contents:

- OS3301: impact socket 10mm
- OS3302: impact socket 11mm
- OS3303: impact socket 12mm
- OS3304: impact socket 13mm
- OS3305: impact socket 14mm
- OS3306: impact socket 15mm
- OS3307: impact socket 17mm
- OS3308: impact socket 19mm



3/8"x1/2" INCREASER

TN

OS 3620

Spare part of OS 3600/OS 3270/
OS 3270BF



1/2"D. x 3/8"D. REDUCER

TN

OM 0047



3/8" RATCHET INSERT 21 PCS

TN

OS 3600

Contents:

- 14 hexagonal sockets: 8, 10, 11, 12, 13, 14, 15, 16, 17, 18, 19, 20, 22, 24mm
- ratchet 3/8" 72 teeth
- 2 extensions 150 and 250mm
- cV joint 3/8"
- sliding handle 3/8"
- 3/8"x1/2" increaser
- 10mm bit holder

Specifications:

- Format: 1/3 drawer
- Insert dimensions:
390x185x50mm





1/2" SOCKET & RATCHET

1/2" TORX PLUS SOCKETS EP10 TO EP20 L.37mm (6 PCS)

OM 7017

Specially designed for Torx Plus indentations, on automatic gearboxes, Nissan clutches and others.
 More resistant to torsion, increased service life compared with classic Torx models.



Not compatible with Torx Classic indentations

TN



TORX "E" SOCKET SET 1/2" D. E10 TO E24 (9 PCS)

OM 7013

Contents:

- OS3031: torx socket E10
- OS3032: torx socket E11
- OS3033: torx socket E12
- OS3034: torx socket E14
- OS3035: torx socket E16
- OS3036: torx socket E18
- OS3037: torx socket E20
- OS3038: torx socket E22
- OS3039: torx socket E24



TN



1/2" RACHET 72 TEETH

OS 3019

Spare part of OS 3000/OS 3050/OS 3055



TN

1/2" DRIVE L. 600MM FORCE HINGED HANDLE

OS 3024

Specifications:

- force hinged handle with replaceable head (SA3025)
- drive: 1/2"
- length: 600mm



TN

1/2" RATCHET INSERT (23 PCS)

OS 3000

Contents:

- 18 hexagonal sockets: 8, 10, 11, 12, 13, 14, 15, 16, 17, 18, 19, 21, 22, 23, 24, 27, 30, 32mm
- ratchet 1/2" 72 teeth
- 2 extensions 125 and 250mm
- cV joint 1/2"
- sliding handle 1/2"

Specifications:

- Format: 1/3 drawer
- Insert dimensions: 390x185x50mm
- DIN ISO 2725-3



TN





SOCKET & RATCHET • 1/2" SOCKET & RATCHET

← FIND THE COMPLETE RANGE OF 1/2" SOCKET & RATCHET HERE

IMPACT SOCKET KIT 10-27mm 1/2" (10 PCS)

TN

OS 3100



10mm - 11mm - 13mm - 14mm - 17mm - 19mm - 21mm - 22mm - 24mm - 27mm



DIN ISO 2725-3



IMPACT SOCKETS SET 1/2" D. L.76mm E10 TO E24 (9 PCS)

TN

OM 7047



E10 - E11 - E12 - E14 - E16 - E18 - E20 - E22 - E24

DIN ISO 3121



LONG HEX IMPACT SOCKET SET 10-30mm 1/2" (13 PCS)

TN

OS 3130



10mm - 11mm - 12mm - 13mm - 14mm - 16mm - 17mm
19mm - 21mm - 22mm - 24mm - 27mm - 30mm

DIN ISO 2725-3



1/2" IMPACT SOCKET BIT SET HUB AND CV JOINT (8 PCS)

TN

OM 7069

Reinforced bushings for cardans and drive shafts.
This kit is specially designed to loosen and retighten nuts and bolts with the impact wrench.

27mm - 30mm - 32mm - 34mm - 36mm



1/2"D. x 3/8"D. REDUCER

TN

OM 0047



3/8"D.x1/2"D. INCREASER

TN

OS 3620

Spare part of OS 3600/OS 3270/
OS 3270BF



1/2"D.x3/4"D. INCREASER

TN

OM 0045



3/4"D. x 1/2"D. REDUCER

TN

OM 0044





1/2"

**MORE
DETAILS**

12.5

6-SIDED SOCKETS



SIZE	SHORT	LONG	REF
8mm	•		OS 3001
10mm	•		OS 3002
11mm	•		OS 3003
12mm	•		OS 3004
13mm	•		OS 3005
14mm	•		OS 3006
		•	OS 3007
15mm	•		OS 3008
		•	OS 3009
16mm	•		OS 3010
17mm	•		OS 3011
		•	OS 3012
18mm	•		OS 3013
19mm	•		OS 3014
		•	OS 3015
20mm	•		OS 3016
21mm	•		OS 3017
22mm	•		OS 3018
23mm	•		OS 3026
24mm	•		OS 3027
27mm	•		OS 3028
30mm	•		OS 3029
32mm	•		OS 3099

TORX SOCKETS



SIZE	SHORT	LONG	REF
E10	•		OS 3031
E11	•		OS 3032
E12	•		OS 3033
E14	•		OS 3034
E16	•		OS 3035
E18	•		OS 3036
E20	•		OS 3037
E22	•		OS 3038
E24	•		OS 3039

TORX+ SOCKETS



SIZE	SHORT	LONG	REF
EP10	•		SA 7080
EP12	•		SA 7081
EP14	•		SA 7082
EP16	•		SA 7083
EP18	•		SA 7084
EP20	•		SA 7085

IMPACT HEXAGON SOCKETS



SIZE	SHORT	LONG	REF
10mm	•		OS 3031
		•	OS 3032
11mm	•		OS 3033
		•	OS 3034
12mm		•	OS 3035
13mm	•		OS 3036
		•	OS 3037
14mm	•		OS 3038
		•	OS 3039

CARDAN SHOCK SOCKETS



SIZE	REF
10mm	SA 0488
11mm	SA 0489
12mm	SA 0490
13mm	SA 0491
14mm	SA 0492
15mm	SA 0493
16mm	SA 0494
17mm	SA 0495
19mm	SA 0496
21mm	SA 0497
22mm	SA 0498
24mm	SA 0499

TORX-CHOC SOCKETS



SIZE	SHORT	LONG	REF
E10		•	OS 3111
E11		•	OS 3112
E12		•	OS 3113
E14		•	OS 3114
E16		•	OS 3115
E18		•	OS 3116
E20		•	OS 3117
E22		•	OS 3118
E24		•	OS 3119





TN

1/2" HEX SOCKET BIT SET (30 PCS)

OM 2335

Contents:

- 9 sockets L.55mm:
5, 6, 7, 8, 10, 12, 14, 17, 19mm
- 8 sockets L.100mm:
5, 6, 7, 8, 10, 11, 12, 13mm
- 7 sockets L.140mm:
5, 6, 7, 8, 10, 12, 14mm
- 6 sockets L.200mm:
5, 6, 7, 8, 10, 12mm



Sockets available individually



1/2" D. IMPACT HEX BIT IMPACT SOCKET SET H4-H19 (9 PCS)

OM 7112

Contents:

- SA0476: socket H4 L.78mm
- SA0477: socket H5 L.78mm
- SA0478: socket H6 L.78mm
- SA0479: socket H8 L.78mm
- SA0480: socket H10 L.78mm
- SA0481: socket H12 L.78mm
- SA0482: socket H14 L.78mm
- SA0483: socket H17 L.78mm
- SA0484: socket H19 L.78mm



Sockets available individually



1/2" TORX SOCKET BIT SET (32 PCS)

OM 2333

Contents:

- 10 sockets L.55mm:
T20, T25, T27, T30, T40, T45, T50, T55, T60, T70
- 10 sockets L.100mm:
T20, T25, T27, T30, T40, T45, T50, T55, T60, T70
- 6 sockets L.140mm:
T40, T45, T50, T55, T60, T70
- 6 sockets L.200mm:
T40, T45, T50, T55, T60, T70



Sockets available individually



IMPACT TORX SOCKET SET 1/2" D. T20-T70 (9 PCS)

OM 7009

Contents:

- SA7009: torx impact socket bit T20
- SA7012: torx impact socket bit T25
- SA7013: torx impact socket bit T30
- SA2352: torx impact socket bit T40
- SA7019: torx impact socket bit T45
- SA7023: torx impact socket bit T50
- SA7024: torx impact socket bit T55
- SA7025: torx impact socket bit T60
- SA7026: torx impact socket bit T70





XZN 1/2" SOCKET BIT SET (26 PCS)

TN

OM 2334

Contents:

- 8 sockets L.55mm:
M5, M6, M8, M9, M10, M12, M14, M16
- 7 sockets L.100mm:
M5, M6, M8, M9, M10, M12, M14
- 7 sockets L.140mm:
M5, M6, M8, M9, M10, M12, M14
- 4 sockets L.200mm:
M8, M10, M12, M14



Sockets available individually



1/2" RIBE SOCKET BIT SET (32 PCS)

TN

OM 2336

Contents:

- 9 sockets L.55mm:
M5, M6, M7, M8, M9, M10, M12, M13, M14
- 9 sockets L.100mm:
M5, M6, M7, M8, M9, M10, M12, M13, M14
- 7 sockets L.140mm:
M8, M9, M10 (VW), M10.3 (FIAT), M12, M13, M14
- 7 sockets L.200mm:
M8, M9, M10 (VW), M10.3 (FIAT), M12, M13, M14



Sockets available individually



IMPACT RIBE WRENCH END SET 1/2"
D. 78mm M5-M14 (9 PCS)

TN

OM 7113

Contents:

- SA0450: Ribe impact socket bit M5 L.78mm
- SA0451: Ribe impact socket bit M6 L.78mm
- SA0452: Ribe impact socket bit M7 L.78mm
- SA0453: Ribe impact socket bit M8 L.78mm
- SA0454: Ribe impact socket bit M9 L.78mm
- SA0455: Ribe impact socket bit M10 L.78mm
- SA0456: Ribe impact socket bit M12 L.78mm
- SA0457: Ribe impact socket bit M13 L.78mm
- SA0458: 1/2" D Ribe impact socket bit M14 L.78mm





1/2"

IN
DETAILS

12.5

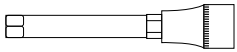

HEXAGON SOCKET

SIZE	SHORT	LONG	REF
5mm	55mm		SA 0370
		100mm	SA 0379
		140mm	SA 0387
6mm	55mm	200mm	SA 0394
		100mm	SA 0371
		100mm	SA 0380
7mm	55mm	140mm	SA 0388
		200mm	SA 0395
		200mm	SA 0372
8mm	55mm	100mm	SA 0381
		140mm	SA 0389
		200mm	SA 0396
10mm	55mm	230mm	SA 0422
		100mm	SA 0373
		100mm	SA 0382
11mm	55mm	140mm	SA 0390
		200mm	SA 0397
		200mm	SA 0374
12mm	55mm	100mm	SA 0383
		140mm	SA 0391
		200mm	SA 0398
13mm	55mm	100mm	SA 0384
		140mm	SA 0416
		140mm	SA 0375
14mm	55mm	100mm	SA 0385
		140mm	SA 0392
		200mm	SA 0399
17mm	55mm	100mm	SA 0386
		140mm	SA 0417
19mm	55mm	140mm	SA 0376
		140mm	SA 0393
22mm	55mm	140mm	SA 0377
		140mm	SA 0378
22mm	55mm	140mm	SA 0379
		140mm	SA 0404

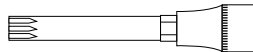

RIBE TIP SOCKETS

SIZE	SHORT	LONG	REF
M5	55mm		SA 0301
		100mm	SA 0302
		140mm	SA 0303
M6	55mm	100mm	SA 0304
		100mm	SA 0306
		100mm	SA 0307
M7	55mm	240mm	SA 0308
		240mm	SA 0309
		240mm	SA 0310
M8	55mm	140mm	SA 0311
		200mm	SA 0312
		240mm	SA 0313
M9	55mm	100mm	SA 0314
		100mm	SA 0315
		140mm	SA 0316
M10	55mm	200mm	SA 0317
		240mm	SA 0318
		240mm	SA 0319
M12	55mm	100mm	SA 0320
		140mm	SA 0321
		200mm	SA 0322
M13	55mm	100mm	SA 0323
		100mm	SA 0324
		140mm	SA 0325
M14	55mm	200mm	SA 0295
		100mm	SA 0296
		140mm	SA 0297
M14	55mm	140mm	SA 0298
		200mm	SA 0299
		100mm	SA 0436
M14	55mm	100mm	SA 0437



HEXAGONAL IMPACT SOCKETS



SIZE	SHORT	LONG	REF
4mm		78mm	SA 0477
5mm		78mm	SA 0478
6mm		78mm	SA 0479
8mm		78mm	SA 0480
10mm		78mm	SA 0481
12mm		78mm	SA 0482
14mm		78mm	SA 0483
17mm		78mm	SA 0484
19mm		78mm	OM 7112



RIBE IMPACT SOCKETS



SIZE	SHORT	LONG	REF
M5		78mm	SA 0451
M6		78mm	SA 0452
M7		78mm	SA 0453
M8		78mm	SA 0454
M9		78mm	SA 0455
M10		78mm	SA 0456
M12		78mm	SA 0457
M13		78mm	SA 0458
M14		78mm	OM 7113

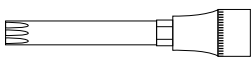

TORX BIT SOCKETS

SIZE	SHORT	LONG	REF
T20	55mm		SA 0262
		100mm	SA 0264
T25	55mm		SA 0265
		100mm	SA 0266
T27	55mm		SA 0267
		100mm	SA 0268
T30	55mm		SA 0269
		100mm	SA 0271
T40	55mm		SA 0272
		100mm	SA 0273
		140mm	SA 0274
T45	55mm	200mm	SA 0275
		100mm	SA 0276
		100mm	SA 0277
T50	55mm	140mm	SA 0278
		200mm	SA 0279
		200mm	SA 0280
T55	55mm	100mm	SA 0281
		140mm	SA 0282
		200mm	SA 0283
T60	55mm	100mm	SA 0284
		100mm	SA 0285
		140mm	SA 0286
T70	55mm	200mm	SA 0287
		100mm	SA 0288
		100mm	SA 0289
T70	55mm	140mm	SA 0290
		200mm	SA 0291
		200mm	SA 0292
T70	55mm	100mm	SA 0293
		140mm	SA 0294

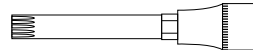

XZN END SLEEVES

SIZE	SHORT	LONG	REF
M5	55mm		SA 0344
		100mm	SA 0345
M6	55mm	140mm	SA 0346
		100mm	SA 0347
M8	55mm	100mm	SA 0348
		140mm	SA 0349
		140mm	SA 0350
M9	55mm	100mm	SA 0351
		140mm	SA 0352
		200mm	SA 0353
M10	55mm	100mm	SA 0354
		140mm	SA 0355
		140mm	SA 0356
M12	55mm	100mm	SA 0357
		140mm	SA 0358
		200mm	SA 0359
M14	55mm	140mm	SA 0360
		200mm	SA 0361
		200mm	SA 0362
M14	55mm	100mm	SA 0363
		140mm	SA 0364
		200mm	SA 0365
M16	55mm	100mm	SA 0366
		140mm	SA 0367
		200mm	SA 0368
M16	55mm	140mm	SA 0369
		140mm	SA 0408



IMPACT SOCKETS TORX



SIZE	SHORT	LONG	REF
T20		78mm	SA 7009
T25		78mm	SA 7012
T30		78mm	SA 7013
T40		78mm	SA 2352
T45		78mm	SA 7019
T50		78mm	SA 7023
T55		78mm	SA 7024
T60		78mm	SA 7025
T70		78mm	SA 7026



IMPACT SOCKETS XZN



SIZE	SHORT	LONG	REF
M12		78mm	SA 0467
M14		78mm	SA 0468



3/4" SOCKET & RATCHET

HGV 3/4" SOCKET SET XZN 16-18 TORX T70-T100 (6 PCS)

TN

OM 2332

Contents:

- SA0470: Socket T70
- SA0471: Socket T80
- SA0472: Socket T90
- SA0473: Socket T100
- SA0474: Socket XZN M16
- SA0475: Socket XZN M18



HEX IMPACT SOCKET KIT 26-38mm 3/4" (8 PCS)

TN

OS 3400

Contents:

- OS3401: impact socket 26mm
- OS3402: impact socket 27mm
- OS3403: impact socket 29mm
- OS3404: impact socket 30mm
- OS3405: impact socket 32mm
- OS3406: impact socket 35mm
- OS3407: impact socket 36mm
- OS3408: impact socket 38mm



DIN ISO 2725-3



3/4" LONG HEX IMPACT SOCKET SET 26-38mm (8 PCS)

TN

OS 3430

Contents:

- OS3431: 3/4" hex impact socket 26mm
- OS3432: 3/4" hex impact socket 27mm
- OS3433: 3/4" hex impact socket 29mm
- OS3434: 3/4" hex impact socket 30mm
- OS3435: 3/4" hex impact socket 32mm
- OS3436: 3/4" hex impact socket 35mm
- OS3437: 3/4" hex impact socket 36mm
- OS3438: 3/4" hex impact socket 38mm



DIN ISO 3129



1" D. 3/4" D. REDUCER

TN

OM 0043



3/4" D. x 1/2" D. REDUCER

TN

OM 0044



1/2" D. x 3/4" D. INCREASER

TN

OM 0045



3/4" D. x 1" D. INCREASER

TN

OM 0033





SOCKET & RATCHET • 3/4" SOCKET & RATCHET

← FIND THE COMPLETE RANGE OF 3/4" SOCKET & RATCHET HERE

RATCHET+10 DOUBLE HEX SOCKET SET 3/4" D. 22-50mm

TN

OM 2355BL



Contents:

- OS3411: double hex socket 22mm
- OS3412: double hex socket 24mm
- OS3413: double hex socket 27mm
- OS3414: double hex socket 30mm
- OS3415: double hex socket 32mm
- OS3416: double hex socket 36mm
- OS3417: double hex socket 38mm
- OS3418: double hex socket 41mm
- OS3419: double hex socket 46mm
- OS3420: double hex socket 50mm
- OS3421: ratchet
- OS3422: extension 100mm
- OS3423: extension 200mm
- OS3424: CV joint
- OS3425: sliding T handle



3/4" RATCHET L.495mm

TN

OS 3421

Spare part of OM 2355/OM 2355BL



3/4" DRIVE L. 950MM FORCE HINGED HANDLE

TN

OS 3426

+ Maximum leverage effect



Specifications:

- force hinged handle with replaceable head (SA3026)
- drive: 3/4"
- length: 950mm



3/4" D. DOUBLE HEX SOCKET Ø56mm FORD TRANSIT

TN

OM 0156



HUB WRENCH DOUBLE HEX Ø65mm 3/4" IVECO DAILY/FORD TRANSIT

TN

OM 0065





1" SOCKET & RATCHET

HEX IMPACT SOCKET KIT 24-50mm 1" (9 PCS)

TN

OS 3500

DIN ISO 2725-3



Contents:

- OS3501: impact socket 24mm
- OS3502: impact socket 27mm
- OS3503: impact socket 30mm
- OS3504: impact socket 32mm
- OS3505: impact socket 35mm
- OS3506: impact socket 38mm
- OS3507: impact socket 41mm
- OS3508: impact socket 46mm
- OS3509: impact socket 50mm



1" LONG HEX IMPACT SOCKET SET 24-50mm (9 PCS)

TN

OS 3530

Contents:

- OS3531: 1" long hex impact socket 24mm
- OS3532: 1" long hex impact socket 27mm
- OS3533: 1" long hex impact socket 30mm
- OS3534: 1" long hex impact socket 32mm
- OS3535: 1" long hex impact socket 35mm
- OS3536: 1" long hex impact socket 38mm
- OS3537: 1" long hex impact socket 41mm
- OS3538: 1" long hex impact socket 46mm
- OS3539: 1" long hex impact socket 50mm

DIN ISO 3129



RATCHET HANDLE+HEX SOCKETS SET 1" D. FOR HG 36-80mm (15 PCS)

TN

OM 2354BL

B.LINE
 BUDGET SOLUTION

Contents:

- OS3511: hex socket 36mm
- OS3512: hex socket 38mm
- OS3513: hex socket 41mm
- OS3514: hex socket 46mm
- OS3515: hex socket 50mm
- OS3516: hex socket 55mm
- OS3517: hex socket 60mm
- OS3518: hex socket 65mm
- OS3519: hex socket 70mm
- OS3520: hex socket 75mm
- OS3521: hex socket 80mm
- OS3522: ratchet
- OS3523: extension 190mm
- OS3524: extension 365mm
- OS3525: sliding T handle



1" RATCHET

TN

OS 3522

Spare part of OM 2354/OM 2354BL



Specifications:

- overall length: 65.5cm
- handle length: 12.5cm





COOLING PLIERS

FLEXIBLE HOSE CLAMP DRIVER 6-7mm

TN

OM 0950



Specifications:

- hose length: 200mm
- handle length: 120mm
- reversible socket 6 and 7mm



SCREWDRIVER+BIT SET (114PCS)

TN

OS 1030BL

Dual-material screwdriver set with magnetic tip mounted on stand or wall bracket.



B.LINE
BUDGET SOLUTION



Contents :

- 6 slotted screwdrivers (3x75, 5x75, 5x100, 6x100, 6x150, 8x150)
- 5 Phillips screwdrivers (0x75,1x75, 1x100, 2x100, 2x150)
- 3 Torx screwdrivers (T10x75, T15x75, T20x75)
- 2 square screwdrivers (S1x75, S2x100)
- 1 bit holder
- 48 bits 6mm : Flat 3-4-4.5-5.5-6-7-8-2xPH0-2xPH1-2xPH2-2xPH3-2xPZO-2xPZ1-2xPZ2-2xPZ3-T6-T8-T10-T15-T20-T25-T27-T30-T35-T40-H1.5-H2.5-H3-H3.5-H4-H4.5-H5-H5.5-H6-H8-S0-S1-S2-S3
- 16 hex wrenches: 1.5-2-2.5-3-4-5-5.5-6mm (1/16",5/64",3/32", 1/8", 5/32", 3/16", 7/32",1/4")
- 20 precision bits: 2x1-2x1.5-2x2mm (2xPH000-2xY000-2xTE0.8-2xTE1.2-2xT4-2xT5-2xT6)
- 6 sockets: 6-7-8-9-10-11
- 6 precision screwdrivers 2.5x40, 3.0x40, PH00x40, PH0x40, T6x40, T8x40mm
- 1 precision bit holder: S3





TN



SCREWDRIVER INSERT (8 PCS)

OS 1000

+ SVCM steel blade

Format: 1/3 drawer
 Insert dimensions: 390x185x50mm
 PP+TPV ergonomic dual material handle
 DIN ISO 2380
 DIN ISO 8764

PH - FLAT SCREWDRIVER SET (8 PCS)

OS 1099

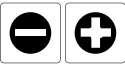

7 PCS TORX SCREWDRIVER INSERT T10-40

OS 1100

Format: 1/3 drawer
 Insert dimensions: 390x185x50mm
 PP+TPV ergonomic dual material handle
 DIN ISO 8764

SCREWDRIVER TORX SET T10-40 (7 PCS)

OS 1199



14 BIT STRIKING SCREWDRIVER SET

OM 0679



- Bits:
- slotted 5-6-8-10-12mm
 - hex 4-5-6-8mm
 - phillips 1-2-3-4
 - torx 40





TOOL SETS

TN



HEX T-HANDLE WRENCH INSERT 3-10mm (7 PCS)

OS 2000

Format: 1/3 drawer
Insert dimensions: 39x185x50mm
PP+TPV ergonomic dual material handle
DIN ISO 2396

+ SVCM steel blade



7 PCS T-HANDLE WRENCH INSERT TORX T10-T40

OS 2100

Format: 1/3 drawer
Insert dimensions: 39x185x50mm
PP+TPV ergonomic dual material handle

+ SVCM steel blade



SPHERICAL HEX KEY SET H1,5-10 (9 PCS)

OS 3220

Spare part of OS 3200/OS 3270



TN

TS 7 KEY SET TS10-TS15-TS20- TS25-TS27-TS30-TS40

OM 7005



TN





TOOL SETS

SCREW BIT SET (100 PCS)

OM 0655BL



Contents:

- 1 magnetic bit holder
- 1 Y adapter
- 1 male adaptor/male square 1/4" hexagonal
- 1 female adaptor/female square 1/4" hexagonal
- 1 socket bit holder 1/4"
- 95 L.25mm bits:
 - Phillips: 0-1-2(x5)-3
 - Pozidrive: 0-1-2(x5)-3
 - Square: R0-1-2-3
 - Flat: 3-4-4.5-5-5.5-6-6.5-7-8
 - Torx: T8-10-15-20-25-27-30-40-45

- Tamperproof Torx: T8-10-15-20-25-27-30-35-40
- Metric hexagonal: H1.5-2-2.5-3-4-5-5.5-6-8
- Hexagonal inch: H1/16-5/64-3/32-7/64-1/8-9/64-5/32-3/16-7/32-1/4
- Tamperproof metric hexagonal: HT2-2.5-3--4-5-6
- Tamperproof hexagonal inch: HT5/64-3/32-7/64-1/8-9/64-5/32
- XZN: M5-6-8
- Tri-wings: TW1-2-3-4
- wrench: SN4-6-8-10
- Clutch: CG1-2-3



TN



32 PCS SCREWDRIVER BIT 1/4" SET

OS 3230

Spare part of OS 3200

Contents:

- 30 screwdriver bits:
 - Pozidrive: PZ1, PZ2 (x2), PZ3
 - Phillips: PH1, PH2 (x2), PH3
 - Slotted: 3, 4, 5, 6
 - Hexagonal: H3, H4, H5, H6
 - Torx: T10, T15, T20, T25, T27, T30, T40
 - Torx tamper: T10, T15, T20, T25, T27, T30, T40
- 1 magnetic socket bit holder 1/4"
- 1 bit holder adaptor for screwers



TN



SPECIAL BIT INSERT (43PCS)

OS 6000

Specifications:

- Format: 1/3 drawer
- Insert dimensions: 390x185x50mm
- DIN ISO 1173
- DIN ISO 3126

Contents:

- 7 short sockets L.30mm 1/4"
 - Pozidrive: PZ1, PZ2, PZ3
 - Hexagonal: H4, H5, H6, H7
- 14 short sockets L.30mm drive 10mm
 - Hexagonal: H8, H10
 - Torx tamper: T10, T15, T20, T25, T30, T35
 - Torx: T45, T50, T55
 - XZN: M6, M8, M10
- 20 long sockets L.75mm drive 10mm
 - Hexagonal: H4, H5, H6, H7, H8, H10
 - Torx tamper: T10, T15, T20, T25, T30, T40
 - Torx: T30, T40, T45, T50
 - XZN: M5, M6, M8, M10
- socket bits holder 1/4", square drive 1/4"
- socket bits holder 10mm, square drive 1/2"



TN





SCREWING • BITS

← FIND THE COMPLETE RANGE OF BITS HERE



BATCH OF BITS

TYPE	DESIGNATION	REF
+	5 BITS SET 1/4" SHORT PZ1	OS 6002
	5 BITS SET 1/4" SHORT PZ2	OS 6003
	5 BITS SET 1/4" SHORT PZ3	OS 6004
6	5 SCREWDRIVER BITS SET 1/4" H3	OS 3238
	5 BITS SET 1/4" SHORT H4	OS 6005
	5 BITS SET 1/4" SHORT H5	OS 6006
	5 BITS SET 1/4" SHORT H6	OS 6007
	5 BITS SET 1/4" SHORT H7	OS 6008
	5 SCREWDRIVER BITS SET 1/4" PH1	OS 3231
	5 SCREWDRIVER BITS SET 1/4" PH2	OS 3232
+	5 SCREWDRIVER BITS SET 1/4" PH3	OS 3233
	5 SCREWDRIVER SLOTTED 3 BITS SET 1/4"	OS 3234
	5 SCREWDRIVER SLOTTED 4 BITS SET 1/4"	OS 3235
-	5 SCREWDRIVER SLOTTED 5 BITS SET 1/4"	OS 3236
	5 SCREWDRIVER SLOTTED 6 BITS SET 1/4"	OS 3237
	5 SCREWDRIVER BITS SET 1/4" T10	OS 3239
+	5 SCREWDRIVER BITS SET 1/4" T15	OS 3240
	5 SCREWDRIVER BITS SET 1/4" T20	OS 3241
	5 SCREWDRIVER BITS SET 1/4" T25	OS 3242
	5 SCREWDRIVER BITS SET 1/4" T27	OS 3243
	5 SCREWDRIVER BITS SET 1/4" T30	OS 3244
	5 SCREWDRIVER BITS SET 1/4" T40	OS 3245
	5 SCREWDRIVER BITS SET 1/4" TORX TAMPER T10	OS 3246
	5 SCREWDRIVER BITS SET 1/4" TORX TAMPER T15	OS 3247
	5 SCREWDRIVER BITS SET 1/4" TORX TAMPER T20	OS 3248
	5 SCREWDRIVER BITS SET 1/4" TORX TAMPER T25	OS 3249
+	5 SCREWDRIVER BITS SET 1/4" TORX TAMPER T27	OS 3251
	5 SCREWDRIVER BITS SET 1/4" TORX TAMPER T30	OS 3252
	5 SCREWDRIVER BITS SET 1/4" TORX TAMPER T40	OS 3253

TORX BITS

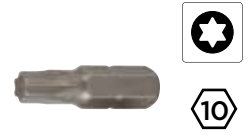

TAILLE	SHORT	LONG	REF
T20	•		SA 2317
		•	SA 2340
T25	•		SA 2318
		•	SA 2341
T30	•		SA 2319
		•	OS 6035
T40	•		SA 2320
		•	OS 6036
T45	•		OS 6017
		•	OS 6037
T50	•		OS 6018
		•	OS 6038
T55	•		OS 6019
		•	SA 2346
T60		•	SA 2347
	•		SA 2324

XZN BITS

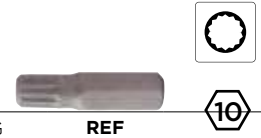

TAILLE	SHORT	LONG	REF
M5	•		SA 2312
		•	OS 6039
M6	•		OS 6020
		•	OS 6040
M7	•		OS 6021
		•	OS 6041
M8	•		OS 6022
		•	OS 6042
M9		•	SA 2316
	•		SA 2339

6-PANEL BOLTS



TAILLE	SHORT	LONG	REF
H4	•		SA 2325
		•	OS 6023
H5	•		SA 2326
		•	OS 6024
H6	•		SA 2327
		•	OS 6025
H7	•		SA 2328
		•	OS 6026
H8	•		OS 6009
		•	OS 6027
H10	•		OS 6010
		•	OS 6028
H12	•		SA 2331
		•	SA 2353

DRILLED TORX BITS



TAILLE	SHORT	LONG	REF
T10	•		OS 6011
		•	OS 6029
T15	•		OS 6012
		•	OS 6030
T20	•		OS 6013
		•	OS 6031
T25	•		OS 6014
		•	OS 6032
T30	•		OS 6015
		•	OS 6033
T40	•		OS 6016
		•	OS 6034

FLAT BITS

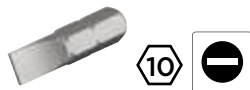

TAILLE	SHORT	LONG	REF
P02	•		SA 2334
P03	•		SA 2335





PLIERS

TN



PLIER INSERT (4PCS)

OS 5000

4 PLIERS SET

OS 5099



Specifications:

- Format: 1/3 drawer
- Insert dimensions: 390x185x50mm



COMBINATION
PLIERS L.180mm

OS 5003



CUTTING PLIERS
L.160mm

OS 5001



LONG-NOSED
PLIERS L.200mm

OS 5002



ADJUSTABLE PLIERS
L.250mm

OS 5004





PLIERS

← FIND THE COMPLETE RANGE OF **PLIERS** HERE

TN

4PCS CIRCLIP PLIER INSERT 7" INSIDE-OUTSIDE

OS 5200

+ High resistance tips



CURVED PLIER
EXTERNAL CIRCLIP 7"

OS 5203



STRAIGHT PLIER
EXTERNAL CIRCLIP 7"

OS 5202



STRAIGHT PLIER INNER
CIRCLIP 7"

OS 5201



CURVED PLIER INNER
CIRCLIP 7"

OS 5204



QUICK-ADJUSTING HGV WATER PUMP PLIER 300mm

OS 5005

TN



Specifications:

- 32-position knob-type adjustment
- max. opening 70mm
- high-strength 58HRC steel
- standard DIN ISO 896



2 PCS HGV CIRCLIP SET (INTERIOR-EXTERIOR)

OM 0111

TN

+ Maximum opening:
85mm



Specifications:

- simple to adjust using the stand
- 3 pairs of interchangeable end fittings for each set
- length 420mm
- max. opening: 75mm





HAMMERING TOOLS

HAMMERING INSERT (10 PCS)

TN

OS 0850

Contents:

- OM0160: rivoir hammer composite handle 1kg
- OM0170: dead blow hammer with interchangeable tip 32mm
- OM0800: extra flat splitting chisel
- OM0803: automatic punch
- OM0801: 6 pin driver set with base
- SA0881: hammering insert 1/3 drawer format



DEAD BLOW HAMMER WITH INTERCHANGEABLE TIP 32mm

TN

OM 0170



SA 1073 2 INTERCHANGEABLE TIPS 32mm POLYURETHANE

SA 1070 2 INTERCHANGEABLE TIPS 32mm NYLON



RIVOIR HAMMER COMPOSITE HANDLE 1000gr

TN

OM 0160



handle length: 360mm



RIVOIR HAMMER ASH TREE HANDLE 1500gr

TN

OM 0161



handle length: 360mm



RUBBER HAMMER 300mm 540g

TN

OM 0540



Specifications:

- handle: wood
- head: rubber Ø57mm
- length: 300mm



FORGED STEEL HAMMER 1250g

TN

OM 0125

handle length: 260mm





HAMMERING TOOLS

← FIND THE COMPLETE RANGE OF **HAMMERING TOOLS** HERE

ANTI-REBOUND HAMMER 4.5kg L.900mm

TN

OM 0135



Allows HGV wheels to be detached when they have adhered to the hub.

- anti-rebound technology
- plastic handle L.780mm
- head dimensions: L .180xW.105xH.105



13 PCS HOLLOW PUNCH SET Ø5-Ø35mm

TN

OM 0581



Contents:

- support for hollow punches
- hollow punches Ø5-6-8-10-11-13-16-19-22-25-28-32-35mm



HOLLOW PUNCH SET Ø3-Ø16mm

TN

OM 0580



Contents:

Ø3-4-5-6-8-9-10-11-12-13-14-16mm



9 LETTER PUNCH SET DIN 8mm

TN

EG 5033



9 LETTER PUNCH SET DIN 10mm

EG 5031

27 LETTER PUNCH SET DIN 8mm

EG 5032



27 LETTER PUNCH SET DIN 10mm

EG 5030





4 PIECE HGV PUNCH SET

OM 0804

TN



Chrome vanadium steel with ergonomic anti-vibration handle.



5 PUNCH SET WITH INSERTED BLADE

OM 0802

TN



Chrome vanadium blade with ergonomic & anti-vibration handle.



6 PIN DRIVER SET WITH BASE

OM 0801

TN



EXTRA LONG BRASS DRIFT 250X20mm

OM 0810

TN



AUTOMATIC PUNCH

OM 0803

TN



FLAT CHISEL

OM 0805

TN



MORTICE CHISEL

OM 0806

TN



EXTRA FLAT SPLITTING CHISEL

OM 0800

TN



LEVER SET WITH STRIKE DISK (4 PCS)

OM 0258

TN

Contents:

- SA0242: lever with strike disk L.200mm
- SA0243: lever with strike disk L.300mm
- SA0244: lever with strike disk L.450mm
- SA0246: lever with strike disk L.600mm





TORQUE WRENCHES

TN

TELESCOPIC L-SHAPED WRENCH 1/2"

OM 0764BL



B.LINE
BUDGET SOLUTION

Specifications:

- length: 365-530mm
- holds sockets in place using ball bearings



120Nm PRESET 1/2" D. TORQUE WRENCH

OM 0765

+ Delivered with calibration certificate

Essential for tightening wheels: thanks to its preset torque, the operator does not waste time. The torque wrench is 375mm long and has a 105° angle for a quick tightening of studs. It makes a click sound when torque is reached.



DIN ISO standard: 6789

Specifications:

- release accuracy ± 4%
- weight: 825g
- length: 375mm



TN

1/2" CROSS TORQUE WRENCH 70-170Nm 490mm + 3 SOCKETS

OM 0755

Combines the precision of a torque wrench with the ease of use of a cross wrench, quick tightening and loosening.



2 in 1



Specifications:

- dimensions: L.540xI.80.5xH.50mm
- torque: 70 - 170Nm
- accuracy: high release ± 4%
- delivered with calibration certificate

Content:

- 3 long sockets 17mm (OM 0756) -19mm (OM 0757) -21mm (OM 0758)
- OM0753: removable cross wrench with free handle
- OM0754: handle with 23,5cm wrench with precision calibration according to DIN 6789.





TORQUE WRENCH 1/2" 40-210Nm 450mm

OM 0790BL

+ Delivered with calibration certificate



TN



TORQUE WRENCHES

TN



Automatic lock

+ Delivered with calibration certificate



REF	Square	Tightening torque	Length	Weight	Precision
OM 0791	1/4"	1-6 Nm	197 mm	260 g	
OM 0794	1/4"	5-25 Nm	240 mm	320 g	
OM 0795	3/8"	10-60 Nm	295 mm	410 g	+/- 3% (tightening)
OM 0796	3/8"	20-120 Nm	420 mm	1000 g	
OM 0792	1/2"	40-220 Nm	525 mm	1150 g	+/- 6% (loosening)
OM 0793	3/4"	100-600 Nm	1000 mm	4890 g	
OM 0797	1"	480-1500 Nm	1000 mm + 800 mm	6700 g	





TORQUE WRENCHES • 1/2" TORQUE WRENCHES

← FIND THE COMPLETE RANGE OF 1/2" TORQUE WRENCHES HERE



1/2" D. ANGLE WRENCH WITH MAGNETIZED ARM

OM 0750



TN



TORQUE WRENCH WITH INTERCHANGEABLE HEADS 3/8" D. 30-110Nm 331mm

OM 0784



Delivered with calibration certificate



Heads: 10-11-12-13-14-15-16-17-18-19
Conform DIN ISO 6789 2017-1

TN





MEASUREMENT & CONTROL

TN



MEASURING TOOLS INSERT (6PCS)

AC 0000

Metrology composition for measurement and precision. It includes the measuring tools used for specific applications (bore, bearings, valve pads, cylinders...) The module of the foam insert allows an optimal storage of the tools.

Specifications:

- Format: 1/3 drawer
- ruler: 150mm
- scribing tip: 146mm
- depth gauge: 200mm
- square: L.100Xl.70mm
- caliper: 150mm
- micrometer 0-25mm

Contents:

- AC0513: caliper
- AC0517: micrometer
- AC0002: depth gauge 200mm
- AC0003: square 100X70mm
- AC0004: tracing point
- AC0005: ruler 150mm



CALIPER TOOL

AC 0513

Spare part of AC 0000

Specifications:

- from 0 to 150mm
- resolution 1/20mm
- depth gauge
- locking knob



TN



DIGITAL CALIPER

AC 0511

Specifications:

- from 0 to 150mm
- resolution: 0.01mm
- reset in any position
- battery LR44 supplied

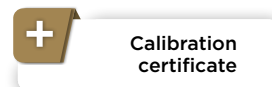

TN



EXTERNAL MICROMETER 0-25mm

AC 0517

Spare part of AC 0000



MICROMETER 25-50mm

AC 0528



TN





CUTTER & SCRAPER

← FIND THE COMPLETE RANGE OF CUTTER & SCRAPERICI

TN

COMPARATOR+MAGNETIC BASE PACK

AC 0520

+ Delivered with calibration certificate



COMPARATOR WITH WORKING RANGE 0-30mm

AC 0514

MAGNETIC BASE FOR COMPARATORS

AC 0515

Comparator specifications (AC0514):

- measurement range 0 to 10mm
- travel/turn: 1mm
- resolution 0,01mm
- chromed-steel case Ø57mm
- fixing rod Ø8mm
- point zero locking screw

Magnetic base specifications (AC0515):

- joint locking
- magnetic base, attraction strength 80kg
- height: 235mm
- vertical stalk Ø12mm
- weight: 1,850kg

AC0514 : 1 x comparateur plage de travail 0-30mm
AC0515 : 1 x support magnetique pour comparateurs



SCRAPER AND UTILITY KNIFE SET

OC 0302



Contents:

- 1 cutter
- 5 straight blades 12mm (OC5301)
- 5 straight blades 16mm (OC5302)
- 5 straight blades 20mm (OC5303)
- 5 bevelled blades 16mm (OC5304)
- 5 trapezoidal blades (OC5305)

TN



SCRAPER WITH HANDLE + 100 BLADES

OC 0303



Blade width: 38mm
Blade height: 19mm

OC0304 : 1 x scraper with handle
OC5497 : 1 x 100 scraper blade set

TN



RETRACTABLE SCRAPER + 100 BLADES

OC 0306



OC0305 : 1 x retractable scraper
OC5497 : 1 x 100 scraper blade set

Blade width: 38mm
Blade height: 19mm

TN



MECHANICS



TIRE & WHEEL

P.198



BRAKING

P.203



OIL DRAINING

P.216



COOLING SYSTEM

P.221



**DIAGNOSTIC
ELECTRONIQUE**

P.226



**CHARGING
SYSTEM**

P.231



AIR CONDITIONING

P.236



**STEERING &
SUSPENSION**

P.251



SILENT BLOC

P.261



HUB

P.266



BEARING

P.281



CLUTCH

P.283



GEARBOX

P.285



TIMING TOOLS

P.292



**SPARK PLUG & GLOW
PLUG**

P.302



INJECTORS

P.304



CYLINDER HEAD

P.315



PISTON & CYLINDER

P.319



FUEL

P.321



ADBLUE®

P.324



WHEEL TIGHTENING

1/2" SHEATHED ALU WHEEL RIM SOCKET SET (5 PCS)

TN

OM 7025

Sheathed sockets to avoid rim damage, colored to enable immediate size identification. Also available on steel rims.

+ Anti-scratch



Maximum tightening/loosening torque:

- socket 15mm: 397Nm
- socket 17mm: 510Nm
- socket 19mm: 637Nm
- socket 21mm: 682Nm
- socket 22mm: 682Nm

Contents:

- SA5015: 15mm impact socket (green)
- SA5022: 17mm impact socket (blue)
- SA5017: 19mm impact socket (gold)
- SA5023: 21mm impact socket (red)
- SA5021: 22mm impact socket (purple)



TN



Hex
L.300mm

1" D. TORQUE CONTROL IMPACT SOCKET
32mm 450Nm

OM 0400

1" D. TORQUE CONTROL IMPACT
SOCKET 32mm 500Nm

OM 0401

1" D. TORQUE CONTROL IMPACT
SOCKET 33mm 550Nm

OM 0402

1" D. TORQUE IMPACT SOCKET EXTRA
DEEP 33mm 650Nm

OM 0403





TN

**TORQUE MULTIPLIER R1:58 4800Nm+6 SOCKETS
+ 2 ADAPTERS 1" HGV**

OM 4535



Torquing and releasing

Contents:

- torque multiplier R1:58 L.270mm
- extension L.255mm
- sockets 24-27-30-32-33-38mm, H.80mm 1" drive
- adapters 1" female-female and 3/4" male-1" female H.80mm



TN

**3/4" 17mm WHEEL NUT SQUARE SOCKET
L.90mm**

OM 0586



**3/4" 19mm WHEEL NUT SQUARE
SOCKET L.90mm**

OM 0587

**3/4" 20mm WHEEL NUT SQUARE
SOCKET L.90mm**

OM 0588

**3/4" 21mm WHEEL NUT SQUARE SOCKET
L.90mm**

OM 0589



TN

ANTI-REBOUND HAMMER 4.5kg L.900mm

OM 0135

Allows HGV wheels to be detached when they are stuck to the hub.



- anti-rebound technology
- plastic handle L.780mm
- head dimensions: L .180xW.105xH.105





WHEEL STUDS THREADING

WHEEL STUD THREAD RESTORER HGV

TN

OM 9311

This tool is designed to restore and align damaged threads. Particularly suitable for wheel studs.



Instructions:

- choose the thread that matches wheel stud
- stretch the thread and place over the base of the stud
- loosen with the thread-holding socket

- M18x1.5mm DAF/IVECO/MAN/Renault/Volvo
 - M20x1.5mm Mercedes/Scania
 - M22x1.5mm DAF/Ford/MAN/Renault/Volvo/Mercedes/Scania
 - 7/8"-11 Scania
 - adapter hex size: 32mm
- The set includes four threads to suit the most common HGV wheel studs thread sizes.



HUB FLANGE CLEANING DISC Ø90-150mm

TN

OM 9343

Specially designed for mounting on a drill/driver or impact wrench, the tool allows quick and easy cleaning of corroded hub flanges, dirty and stuck rim seats, etc. Ideal when changing discs or tyres, the tightening torque is no longer biased by the presence of rust or dirt.



Specifications:

- disc Øint. 90mm ext.150mm
- 1/2" drive

Options:

- CO9351 : disk only
- SA9351 : 1/2" square screwdriver adapter





TIRES RELEASMENT

TIRE RELEASER

OP 1465

- Can be used on the vehicle
- Saves time
- Air regulator
- Handle exhaust
- Agricultural use

Specifications:

- travel: 80mm
- jaw opening: 68mm
- length: 380mm
- connection: 1/4"
- supply pressure: 6.2bar
- consumption: 113l/min

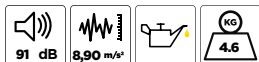

Connector supplied



HYDROPNEUMATIC BEAD BREAKER + PUMP/HOSE/CONNECTOR

DM 1204

Bead breaker specifications:

- adapts to 17.5" to 60" wheels
- max. opening: 130mm
- air inlet, female threading 3/8"

Pump specifications:

- 700bar
- aluminum body
- load limiter
- silent exhaust
- dimensions: L.255xW.135xH.185mm

DM0204 : 1 x hgv/agricultural vehicles hydropneumatic bead breaker

SA0802 : 1 x hose 1/4" l.1500mm

SA4215 : 1 x 1/4"-3/8" hydraulic adapter

OH0024 : 1 x air hydraulic pump 10t 1/4" & 3/8"





TIRE INFLATING

INFLATOR GUN

0.7-12bar

OP 0049



- for passenger cars and vans.
- complies with directive 86/217/EEC
- standard UNI EN 12645
- graduations of 0.7 to 12bar



TN

19L TIRE BEAD BLASTER CAR/ LCV/HGV

OP 0659



Specifications:

- steel tank 19l
- barrel width: 80mm
- discharge: valve (1.5") 1/4 turn
- handle in upper position
- pressure gauge 0-16bar
- safety valve 6.0bar
- working pressure: 7.5bar
- weight : 12kg

TN



12L ALUMINUM AIR BLASTER/BAZOOKA

OP 0679

Allows the tire bead to be placed on the wheel rim.

+ Light and ergonomics



Supplied with PU barrel and metal barrel

Specifications:

- aluminum tank 12L
- PU barrel, does not damage rims
- barrel width: 80mm
- 45° ergonomic handle
- pressure gauge 0-15bar
- 7.5bar safety valve
- operating pressure: 7.5bar
- weight: 4,05kg

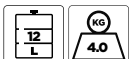

TN

18L ALUMINUM AIR BLASTER/BAZOOKA

OP 0689

Allows the tire base to be positioned on the rim before inflation.

NEW

+ High capacity



Specifications:

- 18L aluminum tank
- 2 PU barrels, no damage to rims
- barrel width: 250mm
- height: 680mm
- ergonomic 45° handle
- pressure gauge 0-16bar
- 10.0bar safety valve
- operating pressure: between 6 and 8 bar
- weight: 13kg

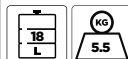

TN

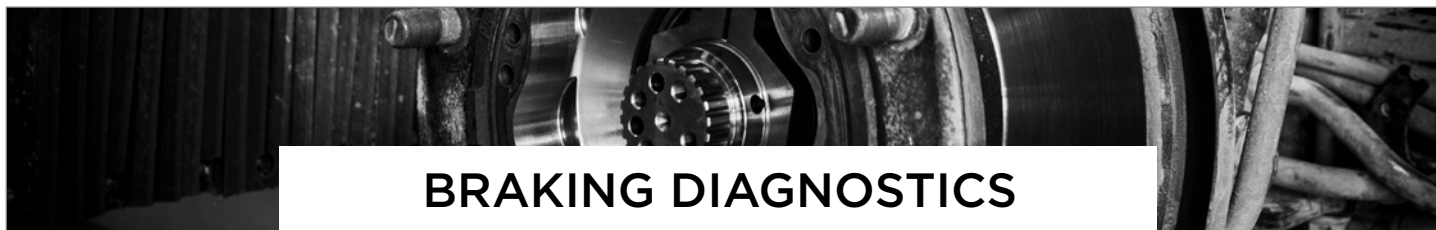

BRAKING DIAGNOSTICS

BRAKE & ABS PRESSURE GAUGE SET+ADAPTERS

AC 5014

This set of brake pressure gauges includes 2 manometers, which connect directly in place of the bleed screws or connections specified by the manufacturer, and allow diagnostics on the brake system (including ABS system).



Contents:

- AC5011 : 1 x brake & abs pressure gauge set
- SA5011 : 1 x brake bleeder european adapters set



TN

COMPARATOR+MAGNETIC BASE PACK

AC 0520

+ Delivered with calibration certificate

Comparator specifications (AC0514):

- measurement range 0 to 30mm
- travel/turn: 1mm
- resolution 0.01mm
- chromed-steel case Ø57mm
- fixing rod Ø8mm
- point zero locking screw

Magnetic base specifications (AC0515):

- joint locking
- magnetic base, attraction strength 80kg
- height: 235mm
- vertical stalk Ø12mm
- weight: 1,850kg



TN

CALIPER BASE Ø DISKS AND BRAKE DRUMS

AC 0519

Specifications:

- working range: 160mm-365mm
- fits a larger range than most similar products on the market
- high-grade steel
- imperial and metric measurement scale



TN

BRAKE FLUID TESTER PROBE

AC 5004

Allows to control the quality of the brake fluid by checking the quantity of water in the fluid. Clear, simple and quick reading of the test result (green/orange/red LED system).



TN

Dot 3-4-5



BRAKING REPAIRING

HYDRAULIC BRAKE PIPE FLARING TOOL SET DIN/SAE Ø4.75-5-6-8mm

OM 8043

This device makes it possible to remake the brake pipe collars. It will produce SAE or DIN impressions, single or double on 4.75mm, 5mm, 6mm or 8mm pipes.

Contents:

- hydraulic gun flaring brake hoses
- frame press flaring brake hoses
- handle M8x1.25 L.119mm
- SAE/DIN die brake hoses Ø4.75mm
- SAE/DIN die brake hoses Ø5mm
- SAE/DIN die brake hoses Ø6mm
- SAE/DIN die brake hoses Ø8mm
- punch OPI for pipes Ø4.75-5mm
- punch OPI for pipes Ø6mm
- punch OPI for pipes Ø8mm
- DIN punch for pipes Ø4.75-5mm
- DIN punch for Ø6mm pipes
- DIN punch for Ø8mm pipes
- punch OPO
- punch 45° Ø4.75-5-6mm
- punch 45° Ø8-10mm

SAE: male cone
DIN: female cone



TN

+ Does not require hose removal



DIN/SAE BRAKE LINE REPAIR KIT

OM 8047



+ No need to remove the line



This tool lets you reshape brake line collars. It produces single or double SAE or DIN shapes on 4.75mm, 5mm or 6mm lines

SAE: male cone
DIN: female cone



REPAIR TOOL SAE MALE/FEMALE SET

OM 8050BL

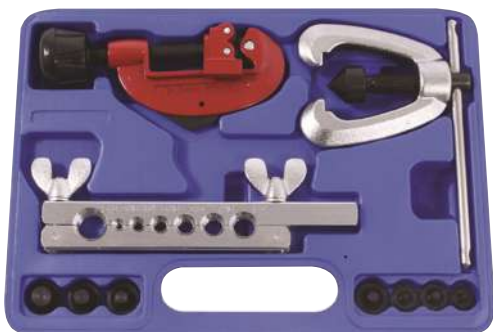

Contents:

- adapters: Ø3/16" (4.75mm)-5/8"-1/2"-7/16"-3/8"-5/16"-1/4"
- tube cutter Ø3 to 30mm

SAE: male cone
DIN: female cone

SA 5323 3/16" ADAPTER Spare part of OM 8050BL/OM 8050





BRAKE HOSE RECTIFIER

OM 8157

Allows easy rectifying of copper brake hoses supplied as a coil.



- knurled handle for a better grip.
- delivered with 3 interchangeable adapter sets: 4.75mm (3/16"), 6.35mm (1/4") and 8mm (5/16")



MINI TUBE CUTTER
Ø3-22mm

OM 8090



MANUAL BRAKE LINE BENDER
Ø3-Ø4-Ø6mm

OM 8057



COPPER CROWN
Ø4.75mm L.7.62m

EG 0565



ASSORTED BRAKE LINE FITTINGS SET (135 PCS)

EG 0007



Contents:

- SA0771: brake lines connectors M10x1 Ø4.75mm stepped base L.18mm (50 pcs)
- SA0772: brake line nuts M10x1 Ø4.75mm (15 pcs)
- SA0773: brake line connectors M10x1 Ø4.75mm L.16mm (20 pcs)
- SA0774: brake line connectors M10x1 Ø4.75mm stepped base L.20mm (20 pcs)
- SA0775: brake line nuts UNF 3/8" Ø4.75mm (10 pcs)
- SA0776: brake line connector UNF 3/8"Ø4.75mm stepped base L.20mm (20 pcs)





**HGV BRAKE PLIERS L.670mm
OPENING 200mm**

OM 0358

TN



**BRAKE PLIERS HGV L.520mm
OPENING 210mm**

OM 0357

TN



**BRAKE DISMOUNTING TOOL
L.450mm-620mm**

OM 0320

TN



**DRUM BRAKE PLIER IVECO/VOLVO WITH
Z-CAM**

OM 0359

TN

Ideal for opening and fixing the brake shoe retaining spring.



Suitable for Iveco, Volvo Z-cam: N7, N10, N12, F7, F12, F16, FH12, FH16, FL7, FL10, ERF E series, EC series

**HALDEX® BRAKE LINKAGE
ADJUSTER EXTRACTOR**

OM 0390

TN



**BPW BRAKE LINKAGE
ADJUSTER EXTRACTOR**

OM 0391

TN





TN

14 BIT IMPACT SCREWDRIVER SET

OM 0679

- Bits:
- slotted 5-6-8-10-12mm
 - hex 4-5-6-8mm
 - phillips 1-2-3-4
 - torx 40



BRAKE SPRING TOOL

OM 8023

Keeps the handbrake cable spring compressed to make the cable easy to attach to the brake lining.



TN

SPRING COMPRESSION TOOL

OM 8022

Easily compresses spring cups when replacing rear brake linings. The striated cone ensures that the cup is held securely for locking.



TN

BRAKE LINING PLIERS

OM 8052



- Specifications:**
- articulated claw
 - sheathed handle for greater comfort
 - 330mm clamp length



TN

HANDBRAKE CABLE PLIER

OM 8053



TN

EXPANDING ENGINE CYLINDER HONE

OM 0503

Allows quick cleaning and de-icing of cylinders by removing carbon deposits. Bevelled stones for an optimal contact surface and more precision. Flexible, diamond knurled shank for a better grip in the chucks.

- Specifications:**
- adjustable from Ø50 to Ø180mm
 - SA5503: 100x11mm stones 3pcs
 - grit 240 medium



TN





Allows the brake caliper screws to be fitted and removed without removing the coupling lever.



3/4" drive for use with torque wrench.
Integrated torque and effective length calculation rule.



3/4" E18 STRIKING WRENCH L.219mm

OM 0418

Applications: Man TGL/TGM

3/4" E20 STRIKING WRENCH L.219mm

OM 0420

Man TGL/TGM

3/4" E24 STRIKING WRENCH L.219mm

OM 0424

Man TGA/TGS/TGX



TN

Allows the brake caliper screws to be fitted and removed without removing the coupling lever.



3/4" drive for use with torque wrench.
Integrated torque and effective length calculation rule.



3/4" M24 STRIKING WRENCH L.219mm

OM 0423

SAF

3/4" M26 STRIKING WRENCH L.219mm

OM 0426

DAF XF95/XF105/196



TN

2 FEMALE TORX SOCKETS FEMALE E20-E24 D. FOR BRAKE CALIPER MAN

OM 4526



For adjusting brake caliper
Exercice: hexagonal 30mm



TN

ABS SEALANT INSTALLATION TOOL VOLVO/RENAULT

OM 8029



TN

CLAMPS FOR RILSAN PIPES Ø6-8-10-12-16mm

OM 0356



This tool is necessary for inserting notched connections into a rilsan/polyamide pipe as it keeps tire pipes (brake) or fuel pipes in good condition.
It can be used for Ø6-8-10-12-16mm thanks to its adjustment knurled screw.
Mainly used for heavy vehicles such as buses, coaches, trucks, tractors.



TN



TN

HGV HUB AND DRUM SUPPORT LOW TRAILER

OH 8004

Specially designed for dismantling or changing drums and hubs on low trailers of heavy trucks (tank carrier type).
Reduces working time by up to 70%.
Limits the risk of accidents (back injury, falling of the stirrup on the feet...etc).

+ Only 1 operator

Specifications:

- stroke: 200mm
- 4 swivelling wheels, 2 of which are braked
- dimensions: 550x300x700mm
- weight: 34Kg



HGV BRAKE CALIPER SUPPORT

OH 8001

Specially designed for dismantling or changing brake calipers, bushings and drums on trucks, buses and industrial vehicles.
Reduces working time by up to 70%.
Limits the risk of accidents (back injury, fall of the stirrup on the feet, etc.)

+ Only 1 operator

Specifications:

- stroke: 200mm
- 4 swivelling wheels, 2 of which are braked
- dimensions: 470x250x700mm
- weight: 35Kg

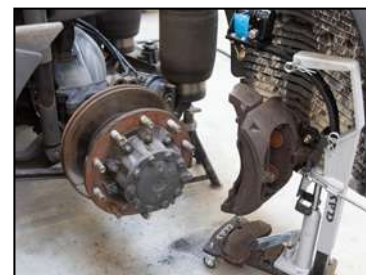

- 4 positions caliper grip:
- 1' (12h)
 - 2' (10h/2h)
 - 3' (9h/3h)
 - 4' (Specific with the offset rod for Mercedes).



TN



TOP PRODUCT

HGV BRAKING TRILOGY

Our comprehensive range of heavy duty hub and brake caliper supports have been designed specifically to make the day-to-day work of operators easier. The benefits are numerous: reduction of musculoskeletal disorders and accidents during work, handling of tools by a single operator, easy extraction of the hub thanks to an effort in the axis of the spindle, saving of time and productivity, coverage of all caliper positions.

1 Brake caliper extraction



OH 8003

2 Hub and brake disc extraction



OH 8010

3 Brake disc release



OH 8013

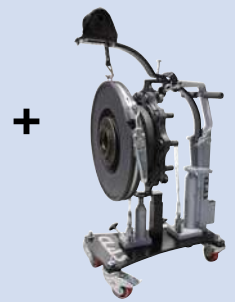

OH 8010

BRAKE SUPPORT AND CALIPERS WIDE BASE HGV

OH 8003

Specially designed for dismantling or changing brake calipers, bushings and drums on trucks, buses and industrial vehicles.
Reduces working time by up to 70%.
Limits the risk of accidents (back injury, fall of the stirrup on the feet... etc).

+ Only 1 operator

Specifications:

- stroke: 200mm
- 4 swivelling wheels, 2 of which are braked
- dimensions : 550x300x700mm

SA 8009 OPTION LOW SOCKET AND BRACKET

Spare part of OH 8003

Bottom connection of the optional swinging caliper.
Multi-position caliper socket from 4h to 8h.



2
WARRANTY

Max. Kg
40

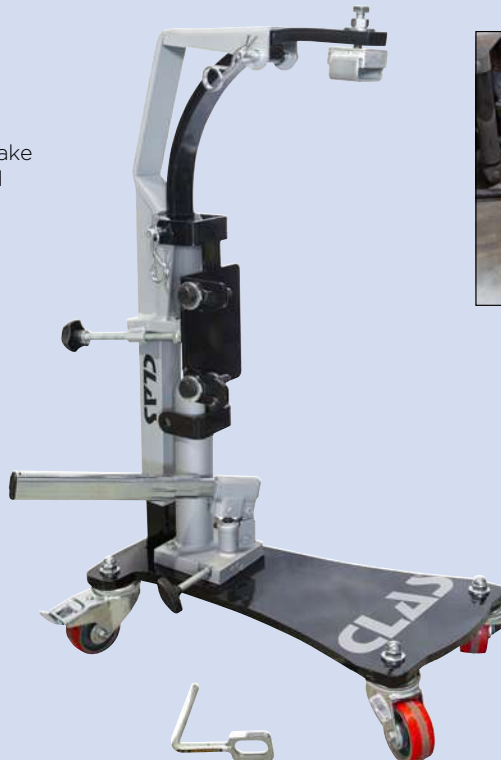

- 4 positions caliper grip:
- 1' (12h)
 - 2' (10h/2h)
 - 3' (9h/3h)
 - 4' (Specific with the offset rod for Mercedes).

2
WARRANTY



DISK / HUB / BRAKE DRUMS SUPPORT

OH 8010

Specially designed to accommodate the entire hub (hub, disc and caliper) when changing bearings on trucks, buses and industrial vehicles. The assembly can be dismantled directly on the support, without effort, assisted by a winch for the removal of the bracket and disc. Limits the risk of accidents (back injury, fall of the stirrup on the feet...).

+ Reduces working time by up to 70%.



Specifications:

- stroke: 200mm
- max winch load: 120kg
- 6 wheels including 2 braked castors
- dimensions: 550x300x700mm
- weight: 49Kg



BRAKE DISC EXTRACTION CYLINDERS HW

OH 8013

Specially designed to separate the discs from the hub in record time when they are stuck by corrosion. Reduces working time and secures the operation by avoiding the use of hammers, discers, cutting machines... Limits the risk of accidents.

Specifications:

- 2 independent 4T jacks on flexible hose L.1500mm
- min length: 84mm
- max length: 125mm
- stroke 41mm
- Ø piston : 32mm
- foot pump max 700bar
- pump hoses length 220mm
- 4 wheels, 2 of which are braked swivel wheels
- dimensions: 470x300x500mm
- weight: 37kg





PNEUMATIC BRAKE CALIPER REWIND SET (22PCS)

OP 4506

This tool enables the user to push back brake caliper pistons easily and with minimum effort, thanks to the gun's pneumatic cylinder which pushes up to 150kg. Operating pressure is 5 to 8bar. Compatible with standard 2-lug brake pads. The set includes 21 adapters, suitable for different types of vehicle.

Developed to reduce braking time and effort.

+ Reduced head thickness
Compatible with highly worn inserts



NEW



Specifications:

- Gun weight: 1.07 kg
- Size : 258x173x97mm
- Working pressure: 7b
- Noise emission: 64.3 dB
- Vibration emission: 0.876 m/s2



BRAKE CALIPER SOCKET SET (18 PCS)

OM 0180

Box specially designed to work on brake calipers and in particular on specific imprints (ex: Porsche, VAG...).

Contents:

- 3/8" d. hex socket bits
H7 recess length 45mm
H7 recess length 65mm
H9 recess length 23mm
H11 recesses length 73mm
- 1/2" hex socket bit :
H10 recesses length 12mm
- 3/8" hex sockets L.25mm: H7, H8
- 1/4" hex socket L.20mm H9
- 1/2" 5 pin sockets: 10, 12.5, 14 and 19mm
- gear lock sockets (7pins) 14 and 22mm
- gear lock sockets (10 pins) 9, 11.5, 15 and 20mm





BRAKE FLUID DRAINING

PNEUMATIC BRAKE AND CLUTCH BLEEDER

TN

HU 1109

For bleeding brakes and hydraulic clutches of all vehicles, can also bleed vehicles equipped with load-sensitive brake control and ABS (max. 1bar).

+ Self-contained air tank



Supplied with:
 • 1 metal plug
 • SA8113 : 2 brake oil recovery jerrycans

Specifications:

- pneumatic operation
- comes with antifoaming rubber membrane
- air reserve in the bottom part of the tank
- 5-litre capacity allows it to be used repeatedly
- fast-connector hose
- balanced carrying handle
- pressure control gauge
- plug storage rack
- compatible with DOT3/ DOT4/DOT5/DOT6 /Pentosin/LHM/LHS
- equipped with an air vent at the hose outlet to prevent air injection into the circuit



12 BRAKE BLEEDER PLUG SET

TN

HU 0700

Accessory of HU 1109/HU 1107/HU 1110/HU 1005/HU 1105/HU 1121/HU 0050BL/HU 1101/HU 1102/HU 1103/HU 1104



Contents:

- 2 conical plugs ranging from 30mm to 80mm
- 10 specific plugs

Alfa Romeo, Citroën, Ford, Opel, Peugeot, Seat, Skoda, Volkswagen, Cadillac, Chevrolet, Chrysler, Daewoo, Daihatsu, Dodge, Honda, Hyundai, Isuzu, Jaguar, Jeep, Kia, Lancia, Land Rover, Lexus, Mazda, Smart, Subaru, Suzuki, Toyota, Aston Martin, Bugatti, Maserati.





TN

ELECTRIC BRAKE BLEEDER AND CLUTCH 5-20L

3.5bar

HU 1102

Automatic stop when the level in the can is too low.
Automatic bleeding after canister change.
Checks low pressure brake system for leaks.
Suction function for expansion vessel, with graduated used liquid recovery canister (1.5L)

+ Maintaining liquid thrust under continuous pressure, pulsating flow

Specifications:

- 230V power supply (5m cord)
- equipped with an on/off switch
- equipped with a pressure regulator 0-3.5bar with maintenance of the thrust of the liquid in pulsating flow
- pressure gauge for pressure control
- suitable for clutches and brakes (compatible with ABS, EDS, ESP, SBC systems)
- capacity 5 to 20 litres, allowing several operations
- dimensions of the tray :
 - height : 500mm
 - width: 300mm
 - depth: 480mm
- interchangeable canister: ensures compatibility of the DOT3/DOT4/DOT5/DOT6 liquid
- flexible L.3.5m
- dimensions: 850x400x330mm
- weight: 23kg



Supplied with metal plug Ø43mm



SA 8113 2 BRAKE OIL RECOVERY JERRYCANS Spare part of HU 1003/HU 1004/HU 1005/HU 1105/HU 1025/HU 1109
Accessory of HU 1101/HU 1102/HU 1103/HU 1104/HU 1121

ELECTRICAL BRAKE AND CLUTCH BLEEDER 30-60L 3.5bar

HU 1103

Automatic stop when the level in the can is too low.
Automatic bleeding after canister change.
Suction function for expansion vessel, with graduated used liquid recovery canister (1.5L)

+ Maintaining liquid thrust under continuous pressure, pulsating flow

Specifications:

- 220V power supply (5m cord)
- equipped with an on/off switch
- equipped with a pressure regulator 0-3.5bar with continuous liquid thrust maintenance
- pressure gauge for pressure control
- suitable for clutches and brakes (compatible with ABS, EDS, ESP, SBC systems)
- capacity 30 to 60 litres, allowing several operations
- interchangeable barrel: ensures compatibility of DOT3/DOT4/ DOT5/DOT6 liquid
- flexible L.3.5m
- dimensions: 920x450x560mm
- weight: 33kg

Recommended for Mercedes Actros/Atego equipped with HPS-1



Supplied with metal plug Ø43mm





**1.7l PRESSURE SPRAYER
BRAKE CLEANER**

TN

OC 1510

+ Designed for use with brake cleaner



Specifications:

- Viton® seals
- adjustable nozzle
- capacity: 1.5l+10%
- graduation: 0.5l-16oz
- graduation dilution 5 and 10
- side relief valve
- expanded Base



**HIGH PRESSURE RECHARGEABLE
SPRAY 650ml**

TN

EG 1532

NEW



Specifications:

- trigger release
- aluminum bottle
- 2-in-1 nozzle (mist and jet)
- Schrader®-type pressurization valve
- 12-bar safety valve



CO 1530 5L CONTAINER OF BRAKES CLEANER Accessory of EG 1530/EG 1532

SET OF 6 BRAKE/CLUTCH BLEED WRENCHES

TN

OM 0501

Specially designed for bleeding brake calipers, the key is equipped with a coupler with retaining gasket, ensuring optimum grip of the bleeding screw (even damaged) without any leakage.



+ Non-return valve for single operator purging

Specifications:

- wrenches 7, 8, 9, 10, 11 and 12mm
- SA2113: hose L.105cm



METAL PRESSURE AND VACUUM PUMP (-1/+ 4bar)

TN

HU 0550

To test: advance vacuum curve pressure regulator for fuel, LPG, EGR valve (exhaust fumes) TURBO...



Specifications:

- turbo boost pressure control
- checks fuel pressure regulator tightness
- vacuum advance curve control
- check relief valve
- injection pump LDA diaphragm tightness check
- check EGR valve
- servo brake diaphragm check
- assistance vacuum pump check

SA8071: 360° rotating pressure gauge
SA8081: set of 8 bits
Supplied in a box





OIL FILTER WRENCHES

FILTER WRENCH 45-111mm + 3/8" + 1/2" D.- 3/8" REDUCER

HU 2004



TN



FILTER WRENCH 122-155mm

HU 2006



TN



Tighten/loosen



METAL STRAP WRENCH FOR IVECO/ VOLVO/RENAULT OIL FILTER

HU 0023

- Ø min: 100mm
- Ø max: 110mm
- drive: 1/2"

TN



DOUBLE-CHAIN FILTER WRENCH Ø60-160mm

HU 2024



TN



OIL FILTER WRENCH Ø135mm 18-SIDED

OM 0315



TN

Applications: Man



OIL FILTER WRENCH Ø107mm 15-SIDED

OM 0337



TN

Applications:

Renault, Volvo, Iveco, Scania, Claas, Demag, Caterpillar, Perta





IVECO OIL FILTER WRENCH SET (3 PCS)

HU 1992



Contents:

- 91x15
- 96.5x15
- 108x15
- SA2069: 1/2"x3/8" reducer



TN

30 MULTI-BRAND CAP OIL FILTER SET

HU 1999

This oil filter wrench set lets you dismantle immersed filters as well as traditional screwed filters.



+ Universal product

3/8" Drive
1/2"-3/8" D. reducer included
Sockets available to retail customers

Renault, PSA, VAG, Opel, Mercedes, Fiat, Lancia, Alfa, Nissan, Honda, Mazda, Mitsubishi,...



TN





WASTE OIL DRAINER

70L GREY WASTE OIL DRAINER

TN

HU 0079BL



B.LINE
BUDGET SOLUTION

NEW

Specifications:

- capacity: 70l
- air pressure for oil discharge: 1 to 2 bar
- standard: tool plate+stand for scroll
- 4 wheels (2 swivel wheels)
- min height: 1005mm
- max height: 1610mm
- total container capacity: 620mm
- Ø tray: 420mm
- drain hose length 1.40m
- weight: 19kg

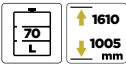

70l MIXED WASTE OIL DRAINER

TN

HU 0189NBL



B.LINE
BUDGET SOLUTION

NEW

Specifications:

- capacity: 70l
- air pressure for oil discharge: 1 to 2 bar
- standard: tool plate+stand for scroll
- 4 wheels (2 swivel wheels)
- min height: 1005mm
- max height: 1610mm
- total container capacity: 620mm
- Ø tray: 420mm
- drain hose length 1.40m
- weight: 19kg



ENGINE OIL TREATMENT 300ml

TN

CO 1009

High performance preventive and curative treatment for oil circuits. Cleans parts in contact with oil, improves combustion, reduces friction and deposits a wear-resistant coating on all petrol and diesel engines. Revives gaskets.



Also available in box of 24



300 ml ENGINE LEAK STOP

TN

CO 1014

Additive to stop oil leaks and seepage on diesel, petrol and LPG engines. Compatible with mineral, semi-synthetic and synthetic oils. Does not clog the oil circuit. Long-lasting effectiveness.



Also available in box of 24



300ml ENGINE CLEANER BEFORE DRAINING

TN

CO 1015

High performance preventive and curative cleaner for oil circuits.

Use before emptying and filling with new oil.



Also available in box of 24



300 ml ANTI-FRICTION ENGINE/GEARBOX

TN

CO 1017

Preventive and curative anti-friction for engines and gearboxes. Reduces friction and provides a wear-resistant coating for long engine life. Revives gaskets.



Also available in box of 24





TN



PNEUMATIC OIL DISTRIBUTOR 24L

HU 0620

Specifications:

- supply for tank discharge: 0.5bar
- level indicator
- trigger with holding in discharge position
- fixed filling funnel, with strainer



FLUID EXTRACTOR/DISPENSER

HU 0631

For motor oil, cooling fluid, brake fluid...
Do not use with flammable liquids



Specifications:

- probe length: 1600mmx3
- Ø6-8-10mm
- manual pump
- pressure/vacuum inverter

TN

25L WASTE OIL DRAINER

HU 0185BL

B.LINE
BUDGET SOLUTION

NEW



Specifications:

- tank height: 470mm
- tank drain 1400mm
- 1400mm suction hose
- 3 flexible probes: Ø8; Ø6; Ø5 / L: 910mm
- 2 rigid probes: Ø6; Ø8 / L: 700mm
- case for probe L 680mm
- mano: from 0.2b to -1b
- venturi system
- supply: 6 to 8bar
- supply for tank emptying: 1bar Max
- level indicator

TN



65L HGV FLUID COLLECTION CONTAINER

HU 0033

For HGV ground draining.
For engine oil, gearboxes...



- equipped with a breakwater grid and anti-drain back
- dimensions: 250x700x500mm

TN

65L HGV PIT COLLECTOR

HU 0114

For engine oil, gearboxes...



- equipped with a breakwater grid and anti-drain back
- drain valve underneath the tank
- waist width adjustment: 750mm mini, 1200mm maxi
- dimensions: 250x700x500mm

TN





OIL SUMP REPAIRING

TN

OIL SUMP REPAIR KIT WITH PLUGS

HU 2050



This kit is designed for damaged oil sump threading repairs

Contents:

- HU2051: Set of 6 plugs+joints+ tap M13x1.25
- HU2052: Set of 6 plugs+joints+ tap M13x1.5
- HU2053: Set of 6 plugs+joints+ tap M15x1.5
- HU2054: Set of 6 plugs+joints+ tap M17x1.5
- HU2055: Set of 6 plugs+joints+ tap M20x1.5
- HU2056: Set of 6 plugs+joints+ tap M22x1.5



13 BLOCK DRAIN PLUGS KIT

HU 2019

These plugs eliminate the problem of damaged oil sumps being tapped, as they replace the original plug without any other intervention.

The thread pitch is the same as the original one, but with a larger thread diameter.

Using these drain plugs does not require the thread to be restored, they should be directly mounted.

Each plug includes a second plug.

Once mounted, the first plug is left on the oil tank while the other plug will be used for the next draining.

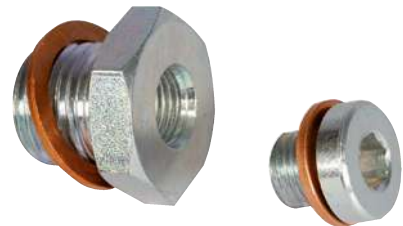

TN



Contents:

- SA2025: plug M10x125 PSA HDI
- SA2024: plug M12x150 Renault/Toyota/Nissan/Mercedes
- SA2023: (x2) plugs M14x125 PSA Diesel and HDI
- SA2022: (x3) plugs M14x150 VW/Audi/Ford/Opel/Mercedes/Fiat JTD
- SA2021: (x3) plugs M16x150 PSA/Renault/Volvo
- SA2020: plug M18x150 PSA/Renault/Volvo/Toyota/Mitsubishi
- SA2019: plug M20x150 Fiat/Alfa/Lancia
- SA2018: plug M22x150 PSA/Fiat
- SA2026: pouch of 10 seals Ø10
- SA2027: pouch of 10 seals Ø12
- SA2032: pouch of 5 rubber seals 1/4"
- 25 copper sealing joints: Ø10mm, 16x1.5
- 5 rubber joints Ø1/4"
- 20 copper joints Ø12mm, 16x1.5



3/8" DRAIN BIT SET (18PCS)

HU 2002



Suitable for draining differentials, axles and gearboxes.

Contents:

- hex: 8-9-10-12-14-17mm
- 3-sided: 10mm
- XZN tamperproof: 16mm
- square: 7-8-10-11-12-13-14-5/16"-3/8"
- square female: 10mm

TN





COOLING PLIERS

TN

Pinch brakes hoses, fuel, heating, cooling, etc.



3 HOSE CLAMP SET

OM 5105

Pinch brakes hoses, fuel, heating, cooling, etc.

OM 5010 HOSE CLAMP Ø6-Ø19mm

OM 5020 HOSE CLAMP Ø12.5-Ø32mm

OM 5030 HOSE CLAMP Ø19-Ø57mm

SET OF 3 L-SHAPED HOSE CLAMP

OM 5104

OM 5014 L-SHAPED HOSE CLAMP Ø15mm

OM 5024 L-SHAPED HOSE CLAMP Ø22mm

OM 5044 L-SHAPED HOSE CLAMP Ø42mm

Specifications:

- 90° elbow



TN



Opening: 80mm

UNIVERSAL CRIMPING PLIER FOR HGV

OM 9390

Tool remotely operatable by cable, for installing/removing the entire range of self-tightening elastic clamps Ø18 to 54mm, even in difficult places to reach.



PLIER FOR CLAMPS WITH DOUBLE GRIP

OM 9389

This multidirectional plier facilitates the removal of self-tensioning clamps (water, fuel, air) which are not easy to reach.



Specifications:

- opening/closing of clamps horizontally or vertically without adjustment
- opening: 70mm
- non-slip handles



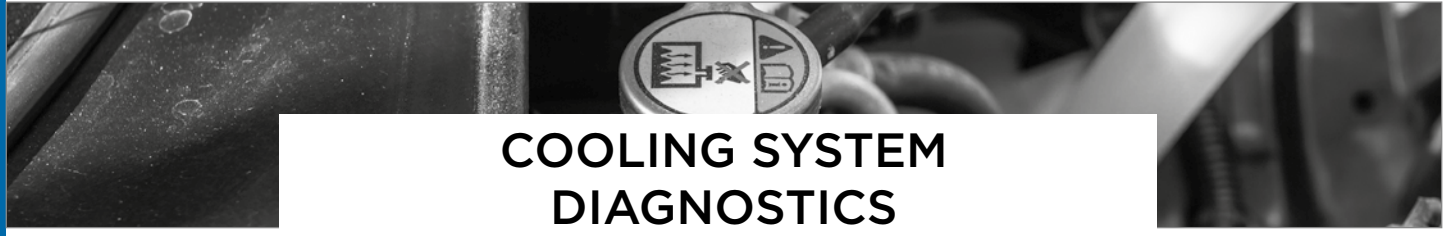

COOLING SYSTEM DIAGNOSTICS

HGV COOLING LINE TESTER SET

AC 1002

Allows simple and quick control by pressurizing the cooling circuits by connecting instead of the expansion tank cap.



Contents:

- 5 metal plugs with quick coupling
- pressure regulator with relief valve
- control manometer 0 to 5bar
- vacuum filling kit
- 3 conical filling adapters
- filling pressure gauge -1 to 0bar
- filling pipes with strainer

Applications: GM, Kenworth, Peterbuilt, Freightliner

TN



BUSES RADIATOR CRANE

OH 8006



Specifically designed for dismantling radiators on buses.

Specifications:

- lifting height: 1890mm
- 4 wheels including 2 braked castors

TN





REFRACTOMETER

AC 4066



- For checking:
- cooling liquid 0 to -50°C
 - battery liquid density: 1.1 to 1.4kg/l
 - windshield washer liquid 0 to -40°C
 - adBlue



CO2 DETECTION KIT

AC 3300

- checks for gas combustion in the radiator
- the test fluid changes colour if a leak is detected
- fast identification of defective head gasket



1- With the engine hot, take off the radiator cap or the expansion-tub cap and put-in the indicated dose of the tracking fluid.

2- Put the bulb on the tube and squeeze it several times. Any gas in the cooling system mixes with the tracking fluid. The blue tracking fluid changes color (turns yellow) if there is an internal combustion fault that forces CO2 into the cooling fluid.

Conclusion: problem with the cylinder head gasket.



AC 3350 CO2 DETECTION FLUID





TN

300 ml COOLING SYSTEM CLEANER

CO 1013

High performance curative cleaner for descaling and cleaning cooling circuits.

Removes deposits and limescale from pipes, hoses and radiators. Removes a protective layer against rust and corrosion. Renovates thermostat gaskets and relieves water pumps.

Dilution: 6 to 7.5% (one bottle for 4 to 5L of coolant)



Also available in box of 24



300ml RADIATOR LEAK SEALER

CO 1012

Plugs leaks in the coolant circuit, ensures the radiators and water pumps are leakproof and avoids overheating.

Allows almost the full circuit to be repaired. This product, which is composed of gel and aluminum flakes, permits you to carry out repairs by creating a patch on non-rigid parts (water container, hoses..) and the aluminum flakes repair the radiator by sealing the leak using the flakes.

Treats 4 to 8L of liquid.

+ Exclusive gel formula with flakes of aluminum incorporated



Also available in box of 24

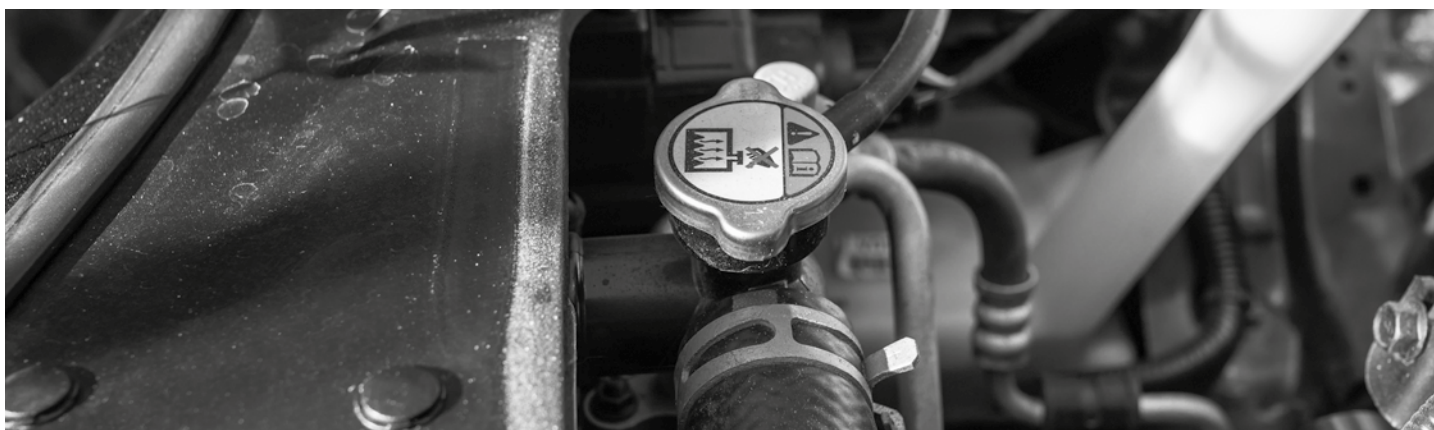



COOLING SYSTEM FILLING

COOLING LINE FILLING DEVICE

TN

AC 1104

Pressure loss system that forces rapid total refilling of the circuit. Compressed air is used to empty the system. Supplied with 4 rubber bushes Ø30-35-39.5-44mm (expanding) suitable for radiator caps from Ø31mm to 52mm. The tool requires the system to have been previously emptied.



2
WARRANTY

CONNECTION DRAIN AND COOLING CIRCUIT FILLING SCANIA

TN

HU 4029



2
WARRANTY





DIGITAL MULTI-PRESSURE TESTER

AC 0800



**1 SET
45 PIECES**

TFT 7" TOUCH TABLET

REINFORCED ABS CASE

1/4" BRASS INSERT

HIGH SPEAKER

FLAT & TORIC GASKETS

USB CABLE FOR PC CONNECTION

STEP-UP/STEP-DOWN

8 QUICK CONNECTORS

SENSOR 0/300 BAR

PRECISION VALVE (NON-RETURN)

SENSOR -1/+3 BAR

FALSE COMMON RAIL DIESEL INJECTOR

DUMMY SPARK PLUG (M12/M14) PETROL

READABILITY DOWN TO A THOUSANDTH OF A BAR

ANALOG PRESSURE GAUGE

RESET TO ZERO

RECORDING FOR PRINTING

DIGITAL MEASUREMENT READOUT

FIXED MAXIMUM MEASURED VALUE

BATTERY LEVEL





AVAILABLE OPTIONS

- ENGINE COMPRESSION
- LOW FUEL PRESSURE
- TURBO PRESSURE
- ADBLUE PRESSURE
- DEPRESSION TEST
- PARTICLE FILTER
- PRESSURE SYSTEM COOLING

EXTRA FUNCTIONS

- DIESEL/PETROL HIGH-PRESSURE TEST
- CYLINDER LEAKS
- OIL PRESSURE
- ETHANOL PERCENTAGE

1 TABLET
1 INFINITY OF MEASUREMENTS



WHY EQUIP YOURSELF ?

<p>PROVIDE MORE ACCURATE DIAGNOSTICS</p>	<p>QUICKLY IDENTIFIES THE FAULTY COMPONENT</p>
<p>APPROPRIATE AND RELEVANT INTERVENTION</p>	<p>TIME-SAVING & PRODUCTIVITY</p>





AVAILABLE OPTIONS



ENGINE COMPRESSION





IDENTIFY THE FAULTY CYLINDER VERY QUICKLY

TN



FLEXIBLE SPARK PLUG PETROL M10X1 200MM
AC 0811



FLEXIBLE SPARK PLUG PETROL M12X1.25 200MM
AC 0812

FLEXIBLE SPARK PLUG PETROL M14X1.25 200MM
AC 0813







DIESEL GLOW PLUG KIT
AC 2024

UNIVERSAL GLOW PLUG
AC 0817

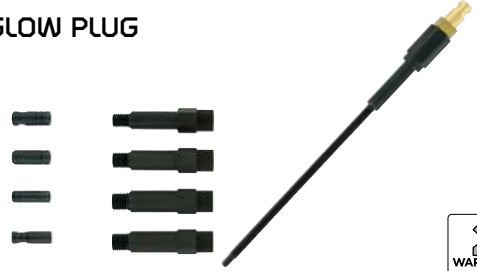
M8/M9/M10



2 WARRANTY

TURBO



PRECISE CONTROL OF THE CONDITION OF THE WASTEGATE AND TURBO FINS

TN

MITYVAC 2.0 ADAPTER
AC 0814



NOTE — Metal pressure and vacuum pump HU 0550 go to p.215



POMPE VENDUE SEPARÉMENT



2 WARRANTY

LOW PRESSURE FUEL & COOLING



ANALYSE THE ENGINE SUPPLY IN TERMS OF LOW FUEL PRESSURE AND COOLING PRESSURE

TN

SCHRADER CONNECTOR 7/16" X 20UNF
AC 0807

SCHRADER CONNECTOR 8VI
AC 0808

SCHRADER CONNECTOR M8X100
AC 0809





NO WARRANTY



ADDITIONAL FUNCTIONS

HIGH FUEL PRESSURE

ANALYSE THE HP FUEL SUPPLY TO THE ENGINE

TN

HIGH PRESSURE FUEL INSERT

AC 0842

FORMAT 3/3
DRAWER

COMPOSITION :

<h4 style="margin: 0;">HIGH-PRESSURE KIT</h4> <p style="background-color: #0070C0; color: white; padding: 2px 5px; border-radius: 5px; font-weight: bold; margin: 5px 0;">AC 0801</p> <div style="text-align: center; margin-top: 10px;"> </div>	<h4 style="margin: 0;">HP DIESEL ELBOW ADAPTERS</h4> <p style="background-color: #0070C0; color: white; padding: 2px 5px; border-radius: 5px; font-weight: bold; margin: 5px 0;">AC 0805</p> <div style="text-align: center; margin-top: 10px;"> </div>	<h4 style="margin: 0;">HP GASOLINE ADAPTERS</h4> <p style="background-color: #0070C0; color: white; padding: 2px 5px; border-radius: 5px; font-weight: bold; margin: 5px 0;">AC 0804</p> <p style="font-size: 10px; margin: 5px 0;">Contents:</p> <ul style="list-style-type: none"> M12x150 M12x125 M14x150 M10x100 M8x100 <div style="text-align: center; margin-top: 10px;"> </div>
<h4 style="margin: 0;">COMMON RAIL DUMMY REGULATOR KIT</h4> <p style="background-color: #0070C0; color: white; padding: 2px 5px; border-radius: 5px; font-weight: bold; margin: 5px 0;">AC 0803</p> <p style="font-size: 10px; margin: 5px 0;">Allows you to check the status of the high-pressure pump regulator.</p> <div style="text-align: center; margin-top: 10px;"> </div>	<h4 style="margin: 0;">COMMON RAIL PLUGS KIT</h4> <p style="background-color: #0070C0; color: white; padding: 2px 5px; border-radius: 5px; font-weight: bold; margin: 5px 0;">AC 0802</p> <p style="font-size: 10px; margin: 5px 0;">M12/M14</p> <p style="font-size: 10px; margin: 5px 0;">Allows you to identify the defective injector by isolating it on the ramp.</p> <div style="text-align: center; margin-top: 10px;"> </div>	<div style="text-align: right; margin-bottom: 10px;"> <p style="font-weight: bold; font-size: 18px; margin: 0;">2</p> <p style="font-size: 8px; margin: 0;">WARRANTY</p> </div>

OIL

CONTROL OIL PRESSURE

TN

OIL PRESSURE ADAPTERS

AC 0815

2

WARRANTY

ETHANOL

CONTROL THE % OF ETHANOL

TN

NEW

ETHANOL E85 CONTROL ADAPTERS

AC 0818

2

WARRANTY

CYLINDER LEAKS

CONTROL CYLINDER SEALING

TN

CYLINDER LEAK TESTER

AC 0816

Livré avec adaptateurs M10/M12/M14

2

WARRANTY





MULTI-PRESSION COMPLETE DIGITAL ROLLER CABINET

AC 0840

NEW



EG 0087

Contents:

- AC0841 : 1 x control panel and accessories insert
- AC0842 : 1 x high pressure fuel insert
- AC0843 : 1 x engine compression and cylinder leak insert
- AC0844 : 1 x oil pressure insert, ethanol and bp fuel
- EG0087 : 1 x 7 drawers roller cabinet



FIND OUT ALL ABOUT THE COMPOSITION ON CLAS.COM

CONTROL PANEL AND ACCESSORIES INSERT

TN

AC 0841



FORMAT 3/3 DRAWER



HIGH PRESSURE FUEL INSERT

TN

AC 0842

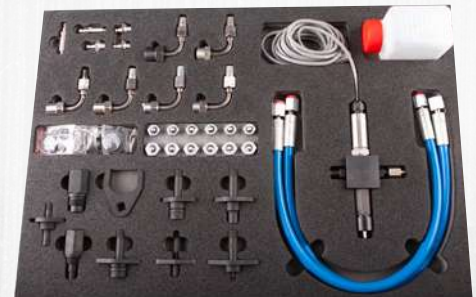

FORMAT 3/3 DRAWER



ENGINE COMPRESSION AND CYLINDER LEAK INSERT

TN

AC 0843



FORMAT 3/3 DRAWER



OIL PRESSURE INSERT, ETHANOL AND BP FUEL

TN

AC 0844



FORMAT 1/3 DRAWER





BOOSTERS

OE 5051

BOOSTER 12V 2500A

Compatible with all 12V vehicles

Specifications:

- peak current (HPCA): 1000A
- starting current (AC): 450A
- cold start current (CCA): 300-330A
- capacity: 22Ah
- cables: 25mm² (1.5in)
- integrated cigarette lighter socket
- charging time: 4-8h
- oversized and insulated copper/brass clamps
- Fuse integrated to the clamp
- shockproof ABS case
- battery : AGM
- weight : 10.6kg
- dimensions : 320x130x300mm



BOOSTER 12-24V 6200A/3100A

OE 5052

+ Mobile and powerful

Specifications:

- peak current (HPCA): 2540A (12V) / 1270A (24V)
- starting current (AC): 1580A (12V) / 790A (24V)
- cold start current (CCA): 1040-1100A (12V) / 520-550A (24V)
- capacity: 2x33Ah (12V) / 33Ah (24V)
- cables : 50mm², L.165cm
- integrated cigarette lighter socket
- charging time: 4-8h
- voltmeter digital charge indicator
- battery : AGM
- weight : 29kg
- dimensions : 410x280x550mm





CHARGING SYSTEM DIAGNOSTICS

TN

12/24V BATTERY TESTER

AC 5245

Instruction manual inside the device
Supplied without a printer.

+ 1800mm of cable
Suitable for start & stop batteries



12/24V BATTERY ELECTRICAL SYSTEM TESTER WITH DETACHABLE PRINTER

AC 5244

Specifications:

- for 12/24V SLI or AGM batteries
- option to select the main national standards of batteries: CCA-SAE-DIN-JIS-IEC-EN-CA
- allows to test: batteries, starters, grounding, alternators (compatible with intelligent alternators), voltmeter
- test report: results can be printed or transferred to a computer (via supplied USB cable)
- multilingual: FR, ENG, ESP, ITA, GER, NL, ROM, FIN, SWE
- paper 55mm width (SA5245 = 2 rolls)



SA 5245	2 PAPER ROLL SET 40mm	Spare part of AC 5244/SA 5244/AC 5244BF/AC 5254 Accessory of AC 5245
SA 5244	PRINTER	Spare part of AC 5244/AC 5244BF Accessory of AC 5245

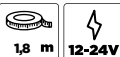



CHARGER

THE CHARGERS ADAPT THE CHARGE TO THE BATTERY CONDITION



Microprocessor management: intelligent charging

PROTECTION OF GOODS AND PEOPLE



Over Discharging protection



Over heating protection



Over charging protection



Reverse connection protection



High voltage protection



Short circuit protection



Over load protection



Protection low voltage

DESULPHATION

CHARGE MAINTENANCE

WORKS ON BATTERY UP TO 3V OF REMAINING CHARGE

OE 8010

AUTOMATIC CHARGER 10 STEPS!

- 1 • ACTIVATION
- 2 • DESULFATION
- 3 • REPAIR
- 4 • PULSED CURRENT CHARGING
- 5 • CONSTANT CURRENT CHARGING
- 6 • CONSTANT VOLTAGE CHARGING
- 7 • FLOAT CHARGING
- 8 • FLAT CHARGING
- 9 • ANALYSIS
- 10 • COMPENSATION CHARGE

BATTERY CHARGER 10A

OE 8010

TN

<p>PLOMB</p> <ul style="list-style-type: none"> AGM MF EFB WET 	<p>LITHIUM</p> <ul style="list-style-type: none"> LiFePo⁴ <p>START</p> <p> STOP</p>
--	--

<ul style="list-style-type: none"> Cèllets avec fusible Pincès crocodiles 	<ul style="list-style-type: none"> Adaptateur allume cigare Connexion rapide 2x1m50 Longueur câble
---	--

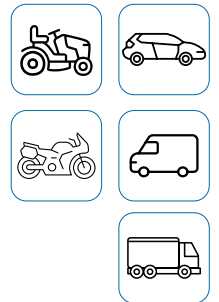

+ Suitable for Lithium batteries

1,5 m	6-12V	160 W	IP 65	B	E
-------	-------	-------	-------	---	---

10A 2 WARRANTY





OVERLOAD CIRCUIT BREAKER 12-24V

TN

OE 1224

This device protects the vehicle electronically from overload.

+ Protect the electronics, avoids reprogramming clock/radio...



Connect the two alligator clips to the battery. If the LED lights up, the device is connected correctly and is ready to use.

Visual and sound signal
Connects directly to the battery terminals, no mounting direction

- Max. clamping voltage 12V:
- 32.5V/308A (8-20µs)
 - 25.2V/59.5A (10-1000µs)
- Max. clamping voltage 24V:
- 59.0V/169A (8-20µs)
 - 45.7V/33A (10-1000µs)



MEMORY SAVER OBDII CIGARETTE LIGHTER

TN

OE 0164

Allows the vehicle to be supplied with power while the battery is disconnected to conserve memories (car radio code, electric seats, etc.).

Keeps, electronic data
The vehicle is powered from the OBDII socket.
Via a cigarette lighter socket, or an additional battery
Equipped with a power supply indicator and reverse polarity protection

+ Memory backup box



- Specifications:**
- cable length: 3m
 - fuse 8A



MALE FEMALE BRUSH FOR BATTERY CABLE TERMINALS CLEANING

TN

EG 5060



LOAD TESTER (LED) FOR 12V BATTERIES AND ALTERNATORS

TN

OE 0035BL



Allows charge level of batteries and 12V alternators to be read thanks to 3 colored LED indicators (red/yellow/green).





BATTERY ACCESSORIES

HGV BATTERY/CATALYTIC CRANE

OH 8005

Specially designed for dismantling and handling batteries and catalyser on trucks, buses and industrial vehicles.

TN

+ Preserves the physical integrity of the operator



Adjustable battery holder

Safety chain



Battery belt

Specifications:

- Max. load: 90kg
- 4 wheels including 2 brake swivelling wheels
- lifting height: 1890mm



90KG 2 WARRANTY





AUTOMATIC AIR CONDITIONING STATION R1234yf

AC 8344

Very easy to use machine, the maintenance of the air conditioning system becomes fun.



Integrated printer



128x64-pixel LCD graphic display Easy, intuitive operation

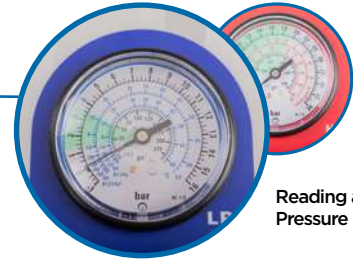

Reading accuracy
Pressure = temperature



Ceinture chauffante
intégrée



Vial mounting quick
connectors



Integrated data
vehicles
Environmentally
friendly use

NEW

Specifications:

- 128x64 pixel LCD graphic display
- 10cc compressor / 50l/min pump / 400g/min recuperator
- 2 hermetically sealed 250ml bottles (used oil, new oil) with anti-moisture filtration system, equipped with male quick-connectors with plunger
- 3m hose kit
- HP/BP quick couplers
- internal cylinder 9Kg / operating limit 1Kg
- scale precision +/- 5g
- calibration/locking tool
- automatic air purge system
- internal cleaning of station circuit
- factory-assembled and tested



R1234yf





TE

AUTOMATIC AIR CONDITIONING STATION R134a

AC 8544

This easy-to-use machine makes air-conditioning system maintenance fun.



128x64-pixel LCD graphic display Easy, intuitive operation



Integrated printer

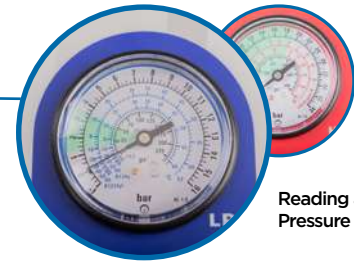

Reading accuracy Pressure = temperature



NEW



Integrated heating belt

+ Integrated data vehicles Environmentally friendly use



Vial mounting quick connectors

R134a

Specifications :

- 128x64 pixel LCD graphic display
- 10cc compressor / 50l/min pump / 400g/min recuperator
- 2 hermetically sealed 250ml bottles (used oil, new oil) with anti-moisture filtration system, equipped with male quick connectors with plunger
- 3m hose kit
- HP/BP quick couplers
- internal cylinder 9Kg / operational limit 1Kg
- heating belt
- scale precision +/- 5g
- calibration/locking tool
- automatic air purge system
- internal cleaning of station circuit
- factory-assembled and tested





DIAGNOSTIC CLIMATISATION

TOP PRODUIT

TN

FILLING KIT FOR NITROGEN/HYDROGEN (N2-H2) LEAK DETECTION 50bar

AC 1017

+ Compatible with R134a and R1234yf gas

The tooling contained in the case is used to "pressurize" the refrigeration and air conditioning systems in order to "simulate", inside the systems, at which pressure it will have to operate.



Contents:

- carrying case
- SA4062: pressure relief valve block with safety valve up to 50bar
- SA4060: insulation pressure gauge + flexible 12cm
- SA4063: reducer for 1kg bottle
- SA1090: hydrogenated nitrogen bottle (N2-H2)1kg
- SA4061: 150cm piping system
- SA4029: high pressure connection
- SA4052: gas-specific high pressure fitting R1234yf



Compatible with small and large bottles



UNIVERSAL ELECTRONIC LEAK DETECTOR R134a/1234YF/HYDROGEN

AC 7495

TN

+ Multi-gas, self-calibration

Specifications:

- sensitivity adjustable on 3 levels
- automatic calibration
- sensor type: semi-conductor
- integrated fan
- power supply: 4 x AA alkaline batteries
- battery life: 4-6h continuously
- low battery indicator
- preheating time 45 s
- probe length: 40cm
- delivered in a suitcase with batteries





TN

ELECTRONIC STETHOSCOPE LEAK DETECTOR

AC 5028

The electronic stethoscope allows you, simply by touching with the tip during static testing, to transmit the sound made by the target through headphones to locate engine pinging, bearing noise, slapping, etc. It also lets you detect air leaks normally imperceptible by the human ear by making the ultrasounds made by an airflow audible.

Specifications:

- can be operated with 2x9V batteries (6f22 type) or equivalent
- response frequency: 36000Hz to 44000Hz
- operating temperature: 0°C to 40°C
- storage temperature: -10°C to 50°C
- weight: amplifier 183g/transmitter 156g

Contents:

- amplifier 176x84x35mm
- ultrasonic transmitter 170x84x36mm
- headphones
- alu stethoscope probe 250mm
- plastic amplifier tube 270mm
- carrying case with foam



DETECTION KIT / AIR CONDITIONING IMPURITIES FILTRATION SYSTEM R134a

AC 1018



R134a

DETECTION KIT / AIR CONDITIONING IMPURITIES FILTRATION SYSTEM R1234YF

AC 1019



R1234yf

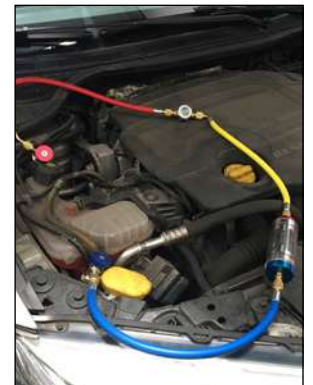

This kit allows you to visually check the condition of the air conditioning circuit.

Controls the quality of the gas according to its clarity, allows to detect the presence of tracer, stop leak, impurities related to the failure of the circuit, or even the compressor.

Our kit is also equipped with a moisture analyzer by changing the color as the gas passes through.



PH NEUTRAL AEROSOL LEAK DETECTOR 400ml

SA 6500

Accessory of AC 1014/AC 1017

Simple and easy to use, this spray allows the identification of leaks in air conditioning systems.

After spraying, bubbles will appear at the leak.

Also available in boxes of 12



TN

TN



CONNECTION 1/4 LOW PRESSURE R134a

TN

SA 4028

Spare part of AC 4029/AC 1014/AC 1016
Accessory of AC 4041/AC 4042/AC 4045/AC 1017/AC 7000



HIGH PRESSURE COUPLER M1/4" R134a

TN

SA 4029

Spare part of AC 4029/AC 1017/AC 1014/AC 1016
Accessory of AC 4041/AC 4042/AC 4045



High pressure connection R134



2 COUPLING M1/4" SAE R134a HIGH & LOW PRESSURE SET

TN

AC 4029



HP QUICK CONNECTOR R134a

TN

AC 9190



QUICK CONNECTOR R134a BP 90° F14x150 - M1/4"

TN

AC 9185



AIR CONDITIONING ADAPTER BMW/VOLVO/ FORD HP

TN

AC 4028

Accessory of AC 1012/AC 1014/ AC 1015/AC 1016



AIR CONDITIONING LP R-134a ADAPTER RENAULT

TN

AC 4027

Spare part of AC 4041/AC 4042/AC 4040
Accessory of AC 4055/AC 1017



HIGH PRESSURE COUPLER FOR GAS R1234yf

TN

SA 4052

Spare part of AC 1017
Accessory of AC 1012/AC 1014/AC 1015/ AC 1016



LOW PRESSURE COUPLER FOR GAS R1234yf

TN

SA 4054

Spare part of AC 1012/AC 1014/AC 1015/AC 1016



AIR CONDITIONING LOW PRESSURE COUPLER FORD FIESTA

TN

AC 4036

Accessory of AC 1017/AC 1012/ AC 1014/AC 1015/AC 1016



AIR CONDITIONING HP 1234yf COUPLER FORD FIESTA

TN

AC 4037

Accessory of AC 1017/ AC 1012/AC 1014/AC 1015/AC 1016



BMW HP CONNECTOR R1234yf

TN

AC 9175





BOTTLE UNIVERSAL ADAPTER 1234YF LP TN

CO 4072



BOTTLE UNIVERSAL ADAPTER 1234YF HP TN

CO 4073



1kg NITRO-TRACE CYLINDER (N2-H2) TN

SA 1090

*Spare part of AC 1017/
AC 1014/AC 1015/AC 1016/
AC 1023*



1kg: Nitrogen 95% and hydrogen 5%



UNIVERSAL CYLINDER ADAPTER R134A HP TN

CO 5063



UNIVERSAL CYLINDER ADAPTER R134A LP TN

CO 5062



2.2kg NITRO-TRACE CYLINDER (N2-H2) TN

SA 1092

*Accessory of AC 1014/
AC 1015/AC 1016/AC 1017/
AC 1023*



Nitrogen 95% and hydrogen 5%





FLEXIBLE 3m R1234yf M12x1.5 x F1/4" SAE RIGHT RED TN

SA 8735

FLEXIBLE 3m R1234yf M12x1.5 x F1/4" SAE RIGHT BLUE

SA 8734



FLEXIBLE 3m F1/4" x F1/4" SAE RIGHT BLUE TN

SA 8732

FLEXIBLE 3m F1/4" x F1/4" SAE RIGHT RED

SA 8733



TN



AIR CONDITIONING R134a
CONTROL SET BY TRACER

AC 4052

Contents:

- OE0396 : 1 x uv mini rechargeable inspection lamp
- SA1002 : 1 x uv glasses
- CO4077 : 1 x 12 syringe tracer pack 7,5ml for r134a gas



AIR CONDITIONING R1234yf
CONTROL SET BY TRACER

AC 4053

Contents:

- OE0396 : 1 x uv mini rechargeable inspection lamp
- SA1002 : 1 x uv glasses
- CO4078 : 1 x 12 syringe tracer pack 7,5ml for r1234yf gas



12 SYRINGE TRACER
PACK 7,5ml FOR R134a
GAS

CO 4077

TN



12 SYRINGE TRACER
PACK 7,5ml FOR R1234yf
GAS

CO 4078

TN



12 SYRINGE TRACER
PACK 7,5ml FOR HYBRID
VEHICLE

CO 4079

TN



UNIVERSAL AIR
CONDITIONING
TRACER 250ml

CO 4068

TN

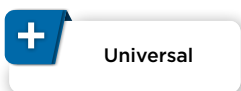

HYBRID VEHICLES
AIR CONDITIONING
TRACER 250ml

CO 4069

TN



UNIVERSAL TRACER
SYRINGE 7,5ml (12 PCS) +
ADAPTER

CO 6253

TN





TN

DIGITAL THERMOMETER

AC 4223



Specifications:

- digital display
- temperature range: - 40° to 250°C
- stainless steel sensor
- automatic stop
- power supply: LR44 battery (included)
- accurate to:
±2% (between -40°C and 200°C)
±3% (between 200°C and 250°C)



DIGITAL ELECTRONIC THERMOMETER

AC 4224



Specifications:

- digital display
- temperature range: -50° to 300°C
- stainless steel sensor
- pressure ±1°C
- battery power 1.5V AAA
- cable length: 900mm
- probe length (chromed part): 170mm
- cable + probe (with handle): 1200mm



INFRARED THERMOMETER

-38°/520°

OE 5036

Reliable measurement thanks to its high-precision laser aimer. Very practical, the infrared thermometer measures surface temperature requiring no contact, remotely and totally safely.



Specifications:

- temperature range: -38°C/520°C (-36.4°F/968°F)
- accuracy: ± 2°C
- response time: 1s
- resolution: 0.1°C°0.1°F
- illuminance automatic stop after 15s
- automatic switch off after 60s if no action taken
- power source: 1.5V battery (x2)



TN

TN





A/C MAINTENANCE

CHOOSING THE RIGHT AIR CONDITIONING OIL

VEHICLE TYPE :



THERMAL



HYBRID

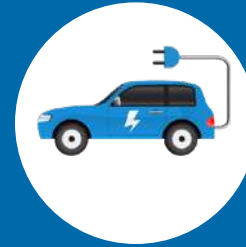

ELECTRIC



MECHANICS
Belt drive

AIR CONDITIONING COMPRESSOR



ELECTRIC
Battery control

AIR-CONDITIONING PAG OIL

Choose **PAG R-134a** or **1234yf** universal air-conditioning oil

Choose a PAG air-conditioning oil with the grade recommended by the manufacturer.

AIR-CONDITIONING POE OIL

- Choose **POE R-134a** or **1234yf** NO SANDEN universal air-conditioning oil
- Choose a POE air-conditioning oil with the grade recommended by the manufacturer.



TN



UNIVERSEL	
REF	NAME
CO 1019	AIR CONDITIONING CIRCUIT CLEANER 400ml
CO 4074	AIR CONDITIONING TRACER SPRAY CLEANER 400ml
CO 4080	UNIVERSAL AIR CONDITIONING OIL 250ml PAG
CO 4081	UNIVERSAL AIR CONDITIONING OIL PAG
CO 4099	UNIVERSAL AIR CONDITIONING OIL POE 80 250ml (EXCEPT SANDEN)



R134a	
REF	NAME
CO 4065	AIR CONDITIONING LEAK STOP FOR R134a 30ml
CO 5003	AIR CONDITIONING OIL PAG 46 250ml - R134a
CO 4093	AIR CONDITIONING OIL PAG 46 1L - R134a
CO 6136	AIRCON OIL PAG 68 250ml - R134a
CO 4094	AIR CONDITIONING OIL PAG 100 1L - R134a
CO 6147	AIRCON OIL PAG 150 250ml - R134a
CO 4095	AIR CONDITIONING OIL PAG 150 1L - R134a
CO 6164	AIRCON OIL POE 32 250ml - R134a
CO 4098	AIR CONDITIONING OIL POE 68 1L - R134a
CO 5001	AIR CONDITIONING OIL POE 68 250ml - R134a
CO 5002	AIR CONDITIONING OIL POE 100 250ml - R134a
CO 5004	AIR CONDITIONING OIL PAG 100 250ml - R134a



R1234yf	
REF	NAME
CO 4070	AIR CONDITIONING LEAK STOP FOR R1234yf 30ml
CO 4096	AIR CONDITIONING OIL PAG 46 250ml - R1234YF
CO 4097	AIR CONDITIONING OIL PAG 100 250ml - R1234YF

NO WARRANTY

VACUUM PUMP OIL ISO 68 500ml

CO 6023

This lubricant is a blend of highly pure base oils with appropriate additives, formulated for the lubrication of rotary vane vacuum pumps or rotary pumps where the use of a lubricant is required. It is used for the lubrication of vacuum pumps and compressed air equipment where lubrication conditions are more critical.



NO WARRANTY

TN



AIR CONDITIONING WASHING KIT

TN

AC 1023

An economical way to remove contaminants and limescale from air conditioning system components.

The process thoroughly cleans the circuit by removing oil, contaminants, refrigerant residues and moisture from the circuit. Essential intervention, when replacing a component of the circuit or simply opening the circuit, to quickly and efficiently remove refrigerant oil and debris when replacing a component (e.g. compressor). Easy to use: simply fill the decontamination solution cartridge, pressurize with the nitrogen cartridge and purge each component. The cleaning solution is a highly evaporating product, so there is no risk of leaving moisture in the circuit. The drying of the circuit is done naturally with the hydrogenated nitrogen gas used. 2 washes with 500ml will be possible.



A/C FLUSHING ADAPTER KIT

TN

AC 4061

Conical adapters kit for the connection of washing equipment to A/C systems.

The kit allows to flush elements of an air conditioning system (like condenser, hose, ...) in a closed circuit. This operation is necessary if the air-conditioning compressor has broken and sent iron filings throughout the circuit.



Contents:

- 2 clamping cones with 1/4 SAE adapter
- 5 sets of plates
- 3 sets of cones
- 1 storage case



LIQUID CANISTER WASHING AIR CONDITIONING 5L

TN

CO 1070

Accessory of AC 1023



Approximately 20 washes



4 COMPARTMENTS ORGANIZER FOR AIR CONDITIONING MAINTENANCE BOX

AC 4021

Accessory of AC 4024/AC 4025/AC 4026/AC 4032/AC 4033/AC 4034

Ideal for grouping aircon maintenance sets.
Can accommodate up to 4 sets.



TN

VALVE/CONNECTOR/PLUG AIR CONDITIONING MAINTENANCE SET

AC 4034

Set of connectors, plugs and valves for all basic maintenance of R134a air conditioning systems.



Components available at retail.



TN

AIR CONDITIONING MAINTENANCE KIT R1234YF

AC 4054

Contents:

- CO4082x4: 20 valve core 19,0x5,12mm R1234yf
- CO4083: 5 valve core 21,8x7,8mm R1234yf
- CO4084: 5 valve core 22,1x9,8mm R1234yf
- CO4085: 5 valve core 21,5,0x7,8mm R1234yf
- CO4086: 5 valve core 20,0x7mm R1234yf
- CO4092: 5 valve core 27,5x7,5mm
- CO4087: 5 plugs M8x1,0 short R1234yf
- CO4088: 5 plugs M8x1,0 long R1234yf
- CO4089: 5 plugs M9x1,0 long R1234yf
- CO4090: 5 plugs M10x0,75 R1234yf
- CO4091: 5 plugs M10x1,25 R1234yf
- AC4048: R12/R134a valve core remover



TN



COFFRETS MAINTENANCE			
	REF	NAME	
	AC 4024	AIR CONDITIONING MAINTENANCE TOOL SET FOR FRENCH VEHICLES (214 PCS)	
	AC 4025	AIR CONDITIONING MAINTENANCE SET FOR GERMAN VEHICLES (171 PCS)	
	AC 4032	AIR CONDITIONING MAINTENANCE SET FOR ASIAN VEHICLES (241 PCS)	
	AC 4026	AIR CONDITIONING MAINTENANCE SET FOR ITALIAN VEHICLES (178 PCS)	
	AC 4033	AIR CONDITIONING MAINTENANCE KIT FOR US VEHICLES (164 PCS)	

O-RING STANDARD KIT

TN

AC 4056

Contents:

- 15 O-rings 7,65x1,76mm
- 15 O-rings 14x1,78mm
- 15 O-rings 10,82x1,78mm
- 15 O-rings 17,17x1,78mm
- 15 O-rings 10,3x2,5mm
- 15 O-rings 6,34x2,5mm
- 15 O-rings 9,3x1,78mm
- 15 O-rings 4,89x1,53mm
- 15 O-rings 20,4x3,5mm
- 15 O-rings 19,18x2,46mm
- 15 O-rings 20x2,5mm
- 15 O-rings 8x2mm
- 15 O-rings 4,5x1,5mm
- 15 O-rings 8,92x1,5mm
- 15 O-rings 6,8x1,78mm
- 15 O-rings 15x3,5mm
- 15 O-rings 9x2,5mm
- 15 O-rings 6,6x6,51mm
- 15 O-rings 6,3x2,5mm
- 15 O-rings 6,5x2mm
- 15 O-rings 7,5x1,65mm
- 15 O-rings 19x2mm
- 15 O-rings 18,5x2,65mm
- 15 O-rings,7x2mm
- 15 O-rings 4,4x1,78mm
- 15 O-rings 21,5x3,5mm
- 15 O-rings 6,8x1,78mm
- 15 O-rings 20x2,5mm
- 15 O-rings 4,4x1,78mm



AIR CONDITIONING VALVE CORE KIT

TN

AC 4057

Contents:

- 20 valve core 19,0x5,12mm
- 10 valve core 21,5x7,8mm
- 5 valve core 20,0x7,0mm
- 5 valve core 18,7x6,0mm
- 5 valve core 21,8x8,0mm
- 5 valve core 22,1x9,8mm
- 5 valve core 18,35x5,1mm
- 5 valve core 27,15x7,8mm
- 5 valve core 18,5x6,5mm
- 5 valve core 19,0x5,12mm - HFO1234yf
- 3 valve core 21,8x8,0mm - HFO1234yf
- 3 valve core 22,1x9,8mm - HFO1234yf





ORIFICE TUBE SET (20 PCS)

AC 4071

The orifice tube is a tube of specified length and cross-section that expands the refrigerant. Unlike the expansion valve, it is not able to regulate the flow rate and superheat.

The orifice tube is always associated with an accumulator at the outlet of the evaporator and consists of three main parts

- a metal tube with a chamfered inlet
- a plastic tube body
- an inlet and outlet filter

The orifice tube must always be replaced when another important part of the circuit is replaced (compressor, condenser, evaporator, accumulator).



Contents:

- CO5079 x2 for Ford/Mazda/Nissan
- CO5078 x2 for Audi/Toyota
- CO5070 x2 for Volvo
- CO5071 x2 for Audi/Fiat/Chrysler/Alfa Roméo
- CO5072 x2 for Ford
- CO5073 x2 for Opel/GM
- CO5074 x2 for Chrysler/Dodge
- CO5075 x2 for Ford/Jeep/Dodge/Hyundai
- CO5076 x2 for Ford/Mazda
- CO5077 x2 for Ford/Jeep/Mazda/Chrysler



AIR CONDITIONING/FUEL DISCONNECTION KIT

AC 4229

7 piece disconnection set specific to air conditioning and fuel hoses quick connectors.



Contents:

- 7 pieces for pipes Ø 1/4", 5/16", 3/8", 1/2", 5/8", 3/4", 7/8"



4 COUPLING PUSH BUTTON SET

AC 4228



Dimensions 3/8", 1/2", 5/8", 3/4"



R12/R134a VALVE CORE REMOVER

AC 4048





CAR CABIN PURIFIER 100mL		
REF	NAME	
CO 1064	CAR CABIN PERCUTABLE PURIFIER 100ml LEMON	
CO 1065	CAR CABIN PERCUTABLE PURIFIER 100ml MUSK	
CO 1066	CAR CABIN PERCUTABLE PURIFIER 100ml MINT	
CO 6221	PERCUTABLE CABIN PURIFIER 100ml LAVENDER	
CO 6222	PERCUTABLE CABIN PURIFIER 100ml PINE	
CO 6223	HABITACLE PERCUTABLE PURIFIER 100ml VANILLA	

NOTEDisponibles en 200ml sur clas.com

CAR CABIN PURIFIER 400mL		
REF	NAME	
CO 1074	CAR CABIN PURIFIER 400ml LEMON	
CO 1075	CAR CABIN PURIFIER 400ml MUSK	
CO 1076	CAR CABIN PURIFIER 400ml MINT	
CO 6216	CABIN PURIFIER 400ml LAVENDER	
CO 6218	CABIN PURIFIER 400ml PINE	
CO 6217	CABIN PURIFIER 400ml FOAMING	
CO 6220	CABIN PURIFIER 400ml VANILLA	
CO 6254	ANTI ANIMAL SMELL SPRAY 200ml	
CO 6255	ANTI-SMOKING SMELL SPRAY 200ml	



AIR CONDITIONING STATION FILTER		
REF	NAME	
CO 6003	AIR CONDITIONING STATION FILTER CTR	
CO 6004	AIR CONDITIONING STATION FILTER ISC L.200mm	
CO 6006	AIR CONDITIONING STATION FILTER OKSYS	
CO 6007	AIR CONDITIONING STATION FILTER ROBINAIR SPX ECOTECNICS	
CO 6010	AIR CONDITIONING STATION FILTER BRAINBEE	
CO 6011	AIR CON STATION FILTER ISC L.230mm	
CO 6012	AIR CON STATION FILTER ROBINAIR	
CO 6013	AIR CON STATION FILTER ECOTECHNICS	
CO 6014	AIR CON STATION FILTER TEXA	

NO WARRANTY



STEERING TIE RODS

DOUBLE DRIVE TIE ROD MASTER WRENCH

OM 9330



This wrench is made to install and remove ball joints with no need to remove the steering rack. It is made up of two reversible serrated drives for perfect removal meaning that it is not necessary to pay attention to the direction in which the tool is positioned.

It can be used with traditional 1/2" D. ratchets and extensions. Thanks to its capacity range (30 to 40mm), it is suitable for all types of cars and LCVs.



TIE-ROD ASSEMBLER/REMOVER Ø30-Ø45mm WITH INTERCHANGEABLE HEADS 4PCS

OM 9175

Allows the quick installation and removal of axial steering rack from 30 to 45mm. The heads consist of a cage with three rollers made of treated steel. The rotation of the tool causes the rollers to lock themselves between the tool body and the ball joint, allowing the axial ball joint to be screwed in and out without damaging it. Compatible with round, hexagonal or octagonal racks.



+ Head equipped with a retaining screw 3 in 1



Specifications:

- Ø head 30-35mm: 72mm
- Ø head 35-40mm: 78mm
- head Ø40-45mm: 90mm
- the head is retained in place using screws for greater security
- 1/2" drive + 32mm hexagonal for greater force
- length including head: 410mm (Hollow)
- weight: 2kg

SA 9175	HEAD Ø30-35mm	Spare part of OM 9175 Accessory of SA 9176/SA 9177
---------	---------------	---

SA 9176	HEAD Ø35-40mm	Spare part of OM 9175 Accessory of SA 9175/SA 9177
---------	---------------	---

SA 9177	HEAD Ø40-45mm	Spare part of OM 9175 Accessory of SA 9176/SA 9175
---------	---------------	---





STEERING & SUSPENSION BALL JOINT

6 PINS REAR SOCKET FOR VOLVO B12 ROLLERS Ø100mm 3/4"

TN

OM 2556

Specially designed for the frame of the Volvo B12 buses and coaches.

NEW



Specifications:

- 6 lugs: 9.7mm long x 5mm thick, 115mm deep

For spherical plain bearings with part numbers: 20994563, 20739867, 70314325, 70321617 and equivalent



BALL JOINT SEPARATOR Ø18mm

TN

OM 2600BL

B.LINE
BUDGET SOLUTION



Specifications:

- to remove rod ends
- suitable for most light vehicles-
- width opening: 20-50mm
- drive profile: 19mm (removal), 22mm (height adjustment)



HYDRAULIC BALL JOINT PULLER KIT Ø30-34-40mm

TN

OH 5020

+ 8T force



8T





BALL JOINT PULLER Ø35mm

OM 0349



Suitable for Mercedes Sprinter and VW LT



TN

BENZ ACTROS PITMAN ARM PULLER Ø42mm

OM 0344



Suitable for Mercedes Actros et Man 414



TN

BALL JOINT ASSEMBLY/DISASSEMBLY SET

OM 2521

Especially designed to remove suspension ball joints.

Contents:

- A. receiver socket 55x69x76mm
- B. receiver socket 46x57.2x63.5mm
- C. receiver socket 46x45x50.8mm
- D. installation adapter 28.6x13.3x76.2mm
- E. removal adapter 28.5x23.9x76.2mm
- F. hex drive screw 22 total length 235mm Ø22x3mm equipped with a push adapter
- G. installation cup adapter 20x47.7mmx56.8mm
- H. swivel press L 222mm I 130mm (useful height 155mm depth 45mm)
- I. receiver socket 60.25x51x57.1mm
- J. installation cup 93.8x44.4x50.8mm



TN



10T UNIVERSAL BALL JOINT/SILENT-BLOCK REMOVER

OM 3615

Accessory of OM 2511/OM 2512/OM 9387

Supplied with universal rings

Compatible with BMW E36



10T



TN

EPL IMPACT SOCKET 32mm 3/4" L.50mm MERCEDES

OM 4532



TN

EPL IMPACT SOCKET 32mm 3/4" L.90mm MERCEDES

OM 4533



TN

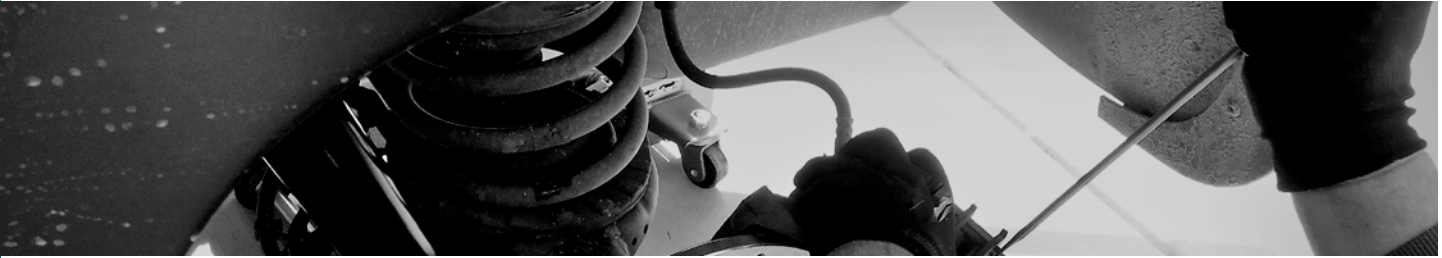

PNEUMATIC CHISEL TOOLS

TN

OP 1480

Chisel set for an easier removal of corroded, seized or crimped parts.



Contents:

- SA1480: chipping/chisel hammer
- SA1481: adapter for 1/2" D. impact sockets
- SA1482: adapter for Ø38-63-74mm blocks
- SA1483: circular shaped block Ø38mm
- SA1484: rounded hollow block Ø63mm
- SA1485: circular shaped block Ø74mm
- SA1486: circular shaped block Ø25mm
- SA1487: rounded hollow block Ø25mm
- SA1488: 10pcs O-rings

Specifications:

- capacity: 2200bpm
- operating pressure: 5 to 8bar
- consumption: 114l/min
- noise level 100dB



STEERING GEARBOX PULLER

TN

OM 7820



Opening Ø60mm
H. 200mm



HYDRAULIC PULLER FRONT AXLE SPACER MERCEDES/MAN

TN

OH 0579





HYDRAULIC PUMP 24V 0-40bar

OH 0011

For brake bleed, clutch system and hydraulic gearshift control HPS2, as well as the system with the new compensation tank. Pressure regulator 0-4bar.



HYDRAULIC CONNECTION KIT VOLVO/SCANIA/RENAULT

TN

OH 0017

Accessory of OH 0011



HYDRAULIC CONNECTION KIT MAN

TN

OH 0019

Accessory of OH 0011



HYDRAULIC CONNECTION KIT IVECO

TN

OH 0018

Accessory of OH 0011



SWIVEL PRESS 100T+PUNCHES

OH 0570

Quick three-dimensional adjustment allowing use directly on vehicles.

Contents:

- 180° swivelling press on mobile trolley with handling handle
- hydropneumatic pump 700bar suitable for body repair/lifting/extraction hydraulic rams
- flexible hose L. 200cm
- Punches:
 - Ø21,5x150mm
 - Ø24,5x150mm
 - Ø29x120mm
 - Ø29x220mm
 - Ø35x120mm
 - Ø39x150mm
 - Ø39x220mm
- MERCEDES ACTROS-SK-0404 ring
- reduction washer 35/25mm
- reduction washer 70/65mm

Inner press frame dimensions:
250x600mm



100T





SPRING & SHOCK ABSORBER

3/4" REAR WHEEL SHOCK ABSORBER
SOCKET SCANIA 34x56mm

TN

OM 0393



3/4" FRONT WHEEL SHOCK ABSORBER
SOCKET SCANIA 28x37mm

TN

OM 0392



3/4" REAR WHEEL SHOCK ABSORBER
SOCKET SCANIA OUTER 34x46mm

TN

OM 0394



3/4" REAR WHEEL SHOCK ABSORBER
SOCKET VOLVO 28x43mm

TN

OM 0395



NUT SPLITTER

TN

OM 0623



This set allows to quickly remove corroded, seized or damaged nuts. The principle is simple: the nut is sheared to release the screw thread. Practical and easy to use, this nut splitter set is a must-have in every workshop.

Contents:

- SA0624: nut splitter for nuts from 9 to 12mm
- SA0625: nut splitter for nuts from 12 to 16mm
- SA0626: nut splitter for nuts from 16 to 24mm
- SA0627: nut splitter for nuts from 22 à 27mm

SA 0624	NUT SPLITTER 9-12mm
SA 0625	NUT SPLITTER 12-16mm
SA 0626	NUT SPLITTER 16-24mm
SA 0627	NUT SPLITTER 22-27mm





TN

TORQUE WRENCH WITH INTERCHANGEABLE HEADS 3/8" D. 30-110Nm 331mm

OM 0784



+ Delivered with calibration certificate



Heads: 10-11-12-13-14-15-16-17-18-19
Conform DIN ISO 6789 2017-1



SHOCK ABSORBER HEAD REMOVAL KIT

OM 1112

This kit is specially designed for installing and removing shock absorber heads. Its go-through socket wrench lets you release or tighten the top cup nut while holding the damper piston steady to prevent it turning.



TN



Contents:

- SA1132: ratchet wrench with loops 21mm
- SA1163: hex go-through socket 16mm L.82mm 1/2"
- SA1164: hex go-through socket 17mm L.82mm 1/2"
- SA1165: hex go-through socket 18mm L.82mm 1/2"
- SA1166: hex go-through socket 19mm L.82mm 1/2"
- SA1167: hex go-through socket 21mm L.82mm 1/2"
- SA1168: hex go-through socket 22mm L.82mm 1/2"
- SA1169: hex go-through socket 24mm L.82mm 1/2"
- SA1170: hex socket bit 6mm L.123mm 1/2"
- SA1171: hex socket bit 7mm L.123mm 1/2"
- SA1172: hex socket bit 8mm L.123mm 1/2"
- SA1173: hex socket 7mm L.123mm 1/2"
- SA1174: hex socket 8mm L.123mm 1/2"
- SA1175: hex socket 9mm L.123mm 1/2"
- SA1176: torx socket bit T50 L.123mm 1/2"
- SA1177: slotted socket bit 5x8 L.123mm 1/2"
- SA1178: slotted socket bit 6x8 L.123mm 1/2"
- SA1179: slotted socket bit 7.1x9.6 L.123mm 1/2"





REINFORCED PNEUMATIC SPRING COMPRESSOR WITH ARTICULATED JAWS

OP 3221

Specially designed to adapt to widely spaced loop springs and securely hold them in place.

Thanks to the innovative articulation system, automatic adjustment takes place when the spring is compressed.

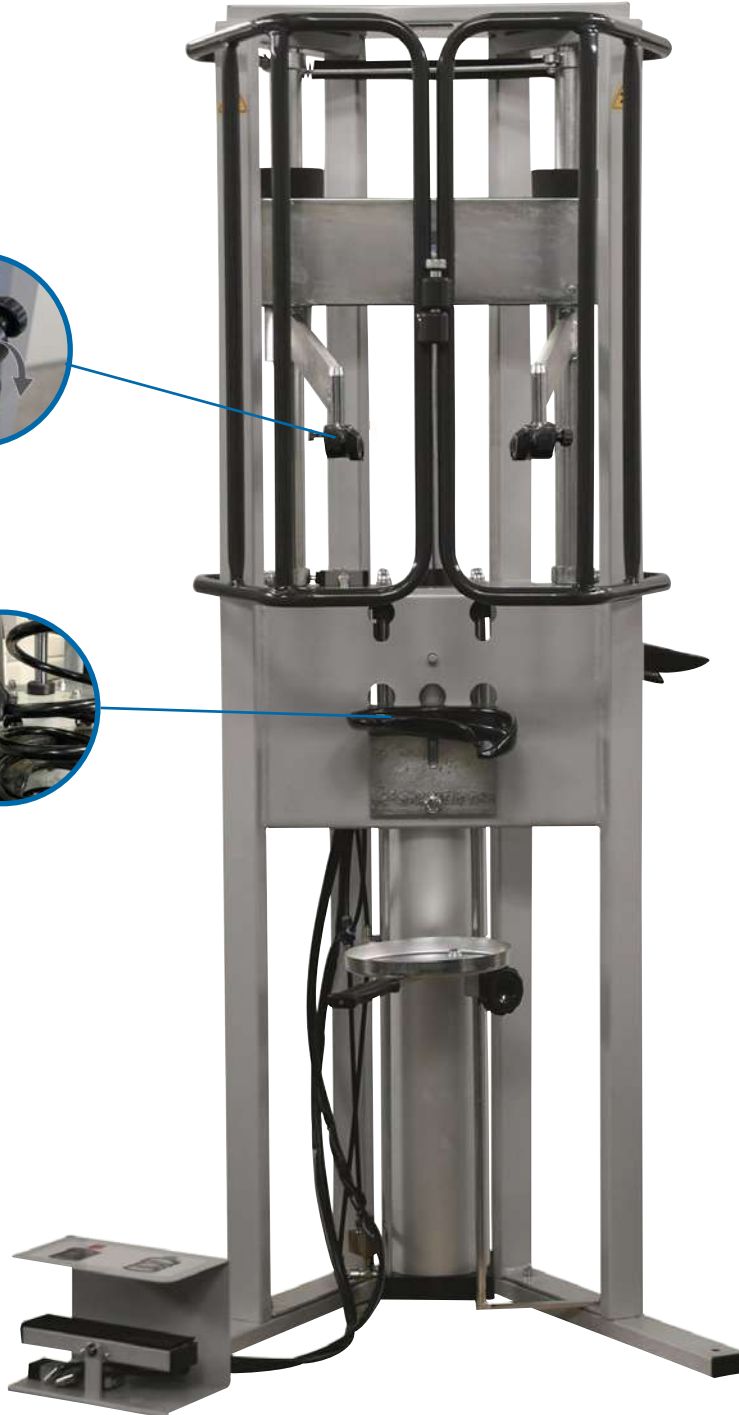

Specifications:

- height: 1600mm
- base: length: 847mm width: 628mm
- working pressure 6bar/max 10bar
- compression strength 2452kg
- use and maintenance instruction book.
- color: grey
- 2 position adjustable lower cup (e.g. Chrysler, Dodge RAM long travel shock absorber...)
- weight: 70kg

Contents:

- OP2003: articulated upper jaws
- SA6904: lower cup 125-205mm
- SA6916: reinforced lower cup 78-130mm
- SA6906: fall protection support



OP 2003 ARTICULATED UPPER JAWS

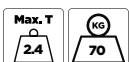



TOP PRODUIT

TN

PNEUMATIC SPRING COMPRESSOR 3T

OP 3231

Specially designed to fit and securely hold coil springs wide apart. Thanks to the innovative articulation system, the adjustment is automatic when the spring is compressed.

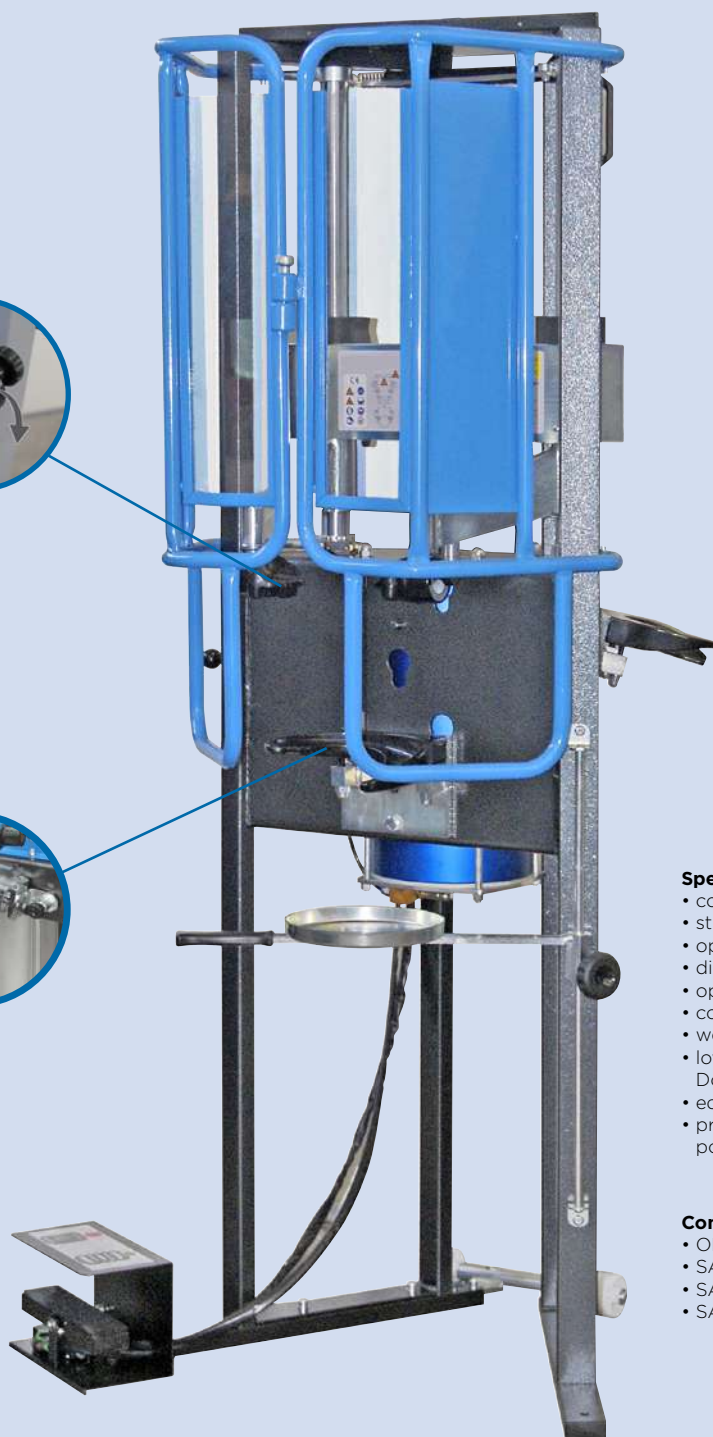

+ Compatible with electric vehicles

Specifications:

- compression force: 3000kg
- stroke: 330mm
- operating pressure: 6bar/max. 10bar
- dimensions: H.1800xL.871xI.690mm
- operating and maintenance instructions
- conformity 2006/42CE
- weight: 110kg
- lower cup adjustable on 2 positions (ex: Chrysler, Dodge RAM long travel shock absorber...)
- equipped with wheels for easy movement
- protection grid lined with high resistance polycarbonate plexiglass

Contents:

- OP2003: articulated jaws
- SA6904: 1 cup Ø125 to Ø205mm
- SA6916: 1 cup Ø78 to Ø130mm
- SA6906: fall arrest support



OP 2003 ARTICULATED UPPER JAWS





SPRING COMPRESSOR 2300Kg

OM 2300



+ Universal Safety: spring lock

This exclusive self-contained compressor is designed with fully adjustable jaws. It has a wide range of coil spring and strut applications. It is portable for convenient use "on or off the car".

Specifications:

- specific design for intervention on front and rear Macpherson type shock absorber
- adjustable jaws for high vehicle compatibility
- intelligent jaw design for optimum spring retention
- impact wrench compatible
- powerful
- security device
- body: 450mm
- compression: 2300Kg
- min-max jaws opening: 100-265mm
- drive: Hex 24mm



2.3T



PAIR OF SPRING COMPRESSORS

OM 3637BL



B.LINE
BUDGET SOLUTION

Specifications:

- 2 long shafts: 330mm, drive 13mm, opening 320mm
- 2 medium shafts: 215mm, drive 13mm, opening 200mm
- 2 short shafts: 175mm, drive 19mm, opening 170mm
- Jaws width 100mm, depth 13mm
- Ømax spring: 16mm





SILENT BLOC

HYDRAULIC PRESS TOOL SET 18T

OM 9386

Universal tool for silent-block, ball joint, bearings or sealing shaft.



This hydraulic press tool set allows for faster removal and reinstallation, efficient, accurate for safe work. No need to put down chassis components like suspension arms or undercarriages. You can work directly on the vehicle and save a lot of time on labor. The OM 9386 set presents long (110mm) and short (40mm) bushes of different diameters (26 to 60mm) and also a 18T hydraulic cylinder which facilitates the extraction of parts to be replaced.

Contents:

- SA9382: hydraulic pump with pressure cups
- SA9389: Threaded rod M20x350 (with o ring to block the sockets)
- SA9383: pressure adapter
- set of 22 short bushes (40mm)
- set of 22 long bushes (110mm)
- plastic case
- SA4215: 1/4"-3/8" adapter

Specifications:

- internal length (press frame): 290mm
- internal width (press frame): 110mm
- maximum load of press frame: 14T
- maximum load of hydraulic cylinder: 18T



18T



HYDRAULIC EXTRACTION SET

OM 9385



Contents:

- SA9384: hydraulic cylinder 18T with 3/8" adapter
- SA9385: push spindle M10x1.5
- SA9386: push spindle M12x1.75
- SA9387: push spindle M14x1.5
- SA9388: push spindle M16x2.0
- 22 short bushes (40mm)
- 22 long bushes (110mm)
- plastic case
- SA4215: 1/4"-3/8" interface connector



18T





SILENT BLOCK

← FIND THE COMPLETE RANGE OF **SILENT BLOCK** HERE

TN

18T HYDRAULIC PRESS PACK + HYDRAULIC AIR PUMP/HOSE/CONNECTOR

OM 9383

Universal tool for silent blocks, ball joints, bearings or sealing rings. This pack allows you to remove and reinstall them quickly, efficiently and precisely in a very safe manner.

Without any need to remove the chassis components such as the suspension arm or the undercarriage, it allows you to work directly on the vehicle and save a considerable amount of time on the labor.

It includes a hydraulic press set with pressure support sockets (L.40mm and L.110mm) with diameters of between 26 and 60mm and an 18T cylinder + 4 extraction rods of 10-12-14-16mm which facilitate the extraction of the parts for replacement.

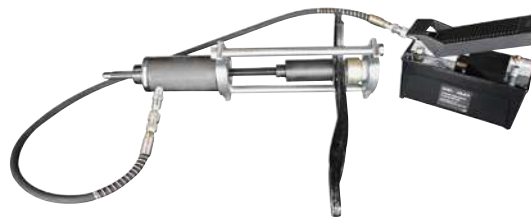

Contents:

- OM9386 : 1 x hydraulic press tool set 18t
- SA0802 : 1 x hose 1/4" L.1500mm
- SA4215 : 1 x 1/4"-3/8" hydraulic adapter
- OH0024 : 1 x air hydraulic pump 10t 1/4" & 3/8"



18T

HYDRAULIC PUMP WITH FRAME AND SPINDLES

SA 9382

Spare part of OM 9385/OM 9386/OM 9387/OM 9287/OM 9383
Accessory of OM 2511/OM 2512/OM 2518/OM 3616/SA 9383

TN



+ Easy, without strain

The hydraulic press enables extraction and setting up of silent-blocks and hubs directly on the vehicle without even removing the car frame.

The cylinder must be coupled with manual pump SA0808 or hydropneumatic pump OH0014, an hydraulic adapter SA4215 and a flexible SA0802 .



18T



UPPER/LOWER HUB RENAULT/OPEL EXTRACTION RING SET

OM 5023

Accessory of OM 3615/OH 0921/OH 0931/OH 0951/
SA 9382/SA 9383/OM 9386/OM 9383

For Renault Master, Opel Movano, Nissan Interstar

TN



Contents:

- OM2511 : 1 x bottom hub extraction rings renauto/opel
- OM2512 : 1 x top hub extraction rings renauto/opel

Compatible with OM3615 and workshop presses.





18T HYDRAULIC EXTRACTION PACK + HYDRAULIC AIR PUMP/HOSE/CONNECTOR

OM 9373

Universal tool for silent blocks, ball joints, bearings or sealing rings. This pack allows you to remove and reinstall them quickly, efficiently and precisely in a very safe manner.

It includes a hydraulic extraction set with pressure support sockets (L.40mm and L.110mm) with diameters of between 26 and 60mm and an 18T cylinder + 4 extraction rods of 10-12-14-16mm which facilitate the extraction of the parts to be replaced.



Contents:

OM9385 : 1 x hydraulic extraction set
SA0802 : 1 x hose 1/4" l.1500mm
SA4215 : 1 x 1/4"-3/8" hydraulic adapter
OH0024 : 1 x air hydraulic pump 10t 1/4" & 3/8"



18T

18T HYDRAULIC EXTRACTOR

OM 9384

Accessory of OM 3420/OM 3424/OM 3425/OM 3426/OM 3427/OM 3428/OM 3429/OM 3430/OM 9387/OM 3417

Hollow ram for extraction and replacement of silent-blocks, ball joints, side shafts, crank shafts, wheel bearings.



Easy, without strain



Options:

- SA0808: manual pump
- OH0014: hydropneumatic pump

Contents:

SA9384 : 1 x hydraulic cylinder removal 18t
SA4215 : 1 x 1/4"-3/8" hydraulic adapter
SA9385 : 1 x threaded rod m10x1.5
SA9386 : 1 x threaded rod m12x1.75
SA9387 : 1 x threaded rod m14x1.5
SA9388 : 1 x threaded rod m16x2.0



18T



SILENT BLOCK

← FIND THE COMPLETE RANGE OF **SILENT BLOCK** HERE

20 LARGE Ø SOCKET SET

OM 9387

Accessory of OM 9385/OM 9373/OM 9386/OM 9383/OM 9382



Contains 10 black long socket (L. 100mm) and 10 gold short socket (L. 30mm) with different diameters (70 to 88mm).



TN

SILENT-BLOCK STAB. BAR EXTRACTOR Ø70mm MERCEDES ACTROS

OM 9370

Accessory of OM 9384/OM 9385



TN

SILENT BLOCK EXTRACTOR SAF Ø158mm

OM 9391



SK INTRAAX XO/XU

Silent-block dimensions: 155/32x114
Silent-block OEM code: 4177302800A



TN

GO-THROUGH MECHADRAULIC CYLINDER 12T+ADAPTERS

OH 3512

Accessory of OM 9381



Specifications:

- force: 12T
- stroke: 8mm
- tightening torque max: 56Nm

Supplied with adapters M10, M12, M14, M16, M18x1.5



12T



TN



TN

HGV SILENT-BLOCK PULLER/INSTALLATION SET

OM 9381

Allows the extraction and installation of split silent-blocks, which need to be compressed to be installed.



Applications of half-rings + support ring:

- Ø56mm: Iveco Eurostar (Cabin)
- Ø58mm: Mercedes 3229B, 650,652 and Volvo
- Ø60mm: Mercedes and Iveco Eurostar (stabilizer), Renault Kerax, Magnum, Premium (blade spring)
- Ø63mm: DAF
- Ø65mm: Mercedes Actros (stabilizer) and Atego
- Ø66mm: Iveco Eurostar (cabin)
- Ø68mm: Man (front), ROR, SAF
- Ø70mm: Man
- Ø75mm: Mercedes Actros (stabilizer)

Contents:

- support sockets (long and short) small diameter
- support sockets (long and short) large diameter
- 9 sets of half-rings + support ring
- silent-block compression vice
- extraction rod M20 + Nuts
- spacer for mechanical-hydraulic cylinder
- 1 step stop



SILENT-BLOCK UNIVERSAL EXTRACTION KIT

OM 9388



SA 9289 THREADED ROD M10x1.5 L.350mm+NUT

SA 9290 THREADED ROD M12x1.5 L.350mm+NUT

SA 9291 THREADED ROD M14x1.5 L.350mm+NUT

SA 9292 THREADED ROD M16x1.5 L.350mm+NUT

Contents:

- 6 stepped end caps for cylinders: 34-36-38-40-42-44-46-48-50-52-54-56-58-60-62-64-66-68-70-72mm
- 4 threaded rods Ø10-12-14-16mm
- 2 guided bearings

Stepped end caps and numbered cylinders for easy identification.





HUB SOCKETS

TN



1" D. IMPACT HEX SOCKET Ø65mm

OM 0565



TN



1" D. IMPACT DOUBLE HEX SOCKET Ø85mm

OM 0585



TN



6 PIN REAR HUB SOCKET
LCV Ø67.5mm 3/4"

OM 0001

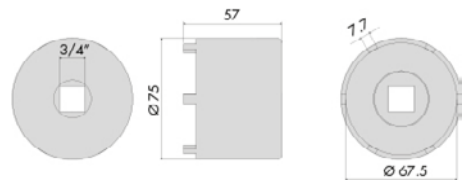

Renault: Movano ,Master
VW: LT, Crafter
Nissan: Interstar
Mercedes: Sprinter (with axles 741,130,131,413,414,416,420,422 ,453,454,455,429)



TN



3/4" D. DOUBLE HEX SOCKET Ø56mm
FORD TRANSIT

OM 0156





TN



REAR HUB BOLT REMOVAL WRENCH
RENAULT/MASCOTT 1" D.

OM 4024

Specifications:

- 4 jug-sockets (width 13.5mm)

Brand: Renault

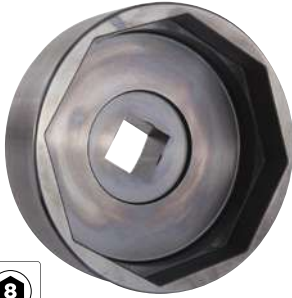

8-SIDED SOCKET Ø116mm
RENAULT/VOLVO/DAF

OM 0343

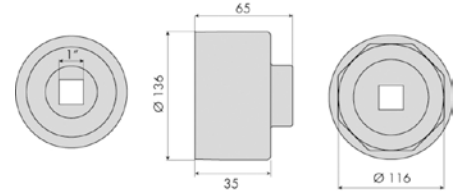

TN



1" D. IMPACT HEX SOCKET Ø77mm

OM 0567

Renault Mascott 4



TN



HEX HUB SOCKET RENAULT
FONTENAC TRAILER Ø160mm

OM 0336

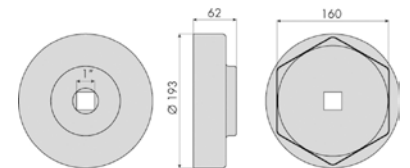

TN



1" D. HEX REAR HUB SOCKET
IRISBUS/VOLVO Ø105mm

OM 0342

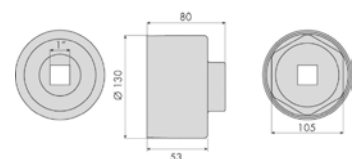

TN



TN



6 PIN FRONT HUB SOCKET MAN Ø76.5mm

OM 0319

Suitable for front axles M3, ME, MI and for rear axles 3MR, 5MR

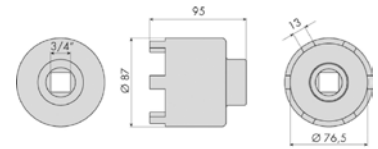

TN



4-PIN MAN TRANSMISSION SOCKET Ø53.5mm

OM 0352

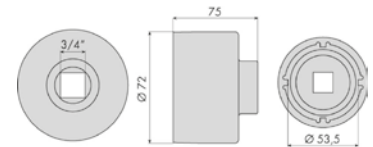

TN



6 PIN FRONT HUB SOCKET MAN Ø92,5mm

OM 0306

Suitable for Man TGA V9, 82L, 01, F2000

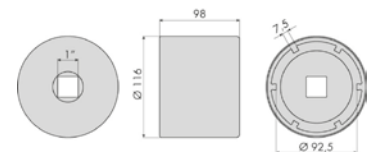

TN



6 PIN DRIVE AXLE NUT SOCKET MAN TGA Ø118mm

OM 0384

Suitable for MAN TGA 460 axles, V9-82L-01 (disc brakes & ABS).
Removable guide.

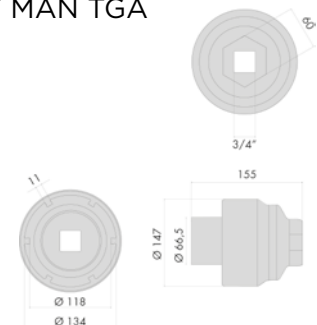

TN



6 PIN FRONT HUB SOCKET MAN Ø77mm

OM 0318

Suitable for front axles VW2, 4, 6.1 and 6.8

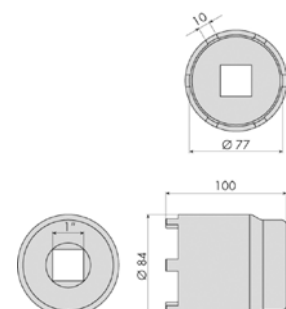



TN



MAN/MERCEDES DIFFERENTIAL
REAR NUT 6 PIN SOCKET
Ø113mm

OM 0353

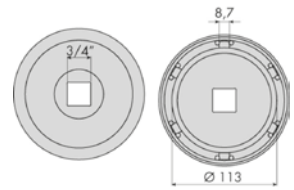

TN



RECTANGULAR HUB SOCKET
MAN/MERCEDES 60x76mm

OM 0313

Suitable for DAF, KASSBOHRER/
SETRA Man and Mercedes
SK VL5/1 D-9 series 2629 in 6x4, 2635K
in 6x4 and 3535K in 8x4

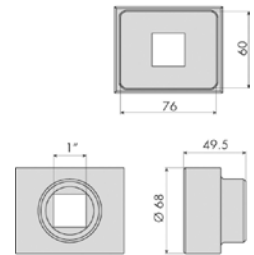

TN

6 PIN SOCKET FOR REAR AXLE
NUT MERCEDES CITARO Ø123.5mm

OM 0354

For ZF car lifts
Pin width: 10.8mm
Hex. drive 32mm



TN

6 PIN HUB SOCKET SPRINTER
Ø63mm

OM 0303

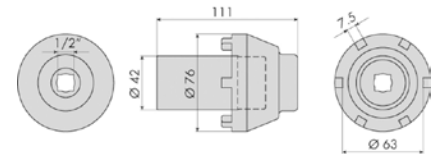

Rear models: HL 0/3, 0/6, 0/7, HL
1/2, 1/3, 1/8, 1/9, HL 2/2, 2/3, 2/5, 2/9,
2/11, 2/12, 2/15
Specific to Sprinter 412T, VW LT



HEXAGONAL SOCKET
FOR MERCEDES/EVOBUS
DIFFERENTIAL NUTS Ø72mm

OM 0350

Suitable for Mercedes Citaro
et EvoBus, ZF axle 132



TN

6 PIN REAR AXLE SOCKET VARIO/
SPRINTER/ATEGO Ø88mm

OM 0323

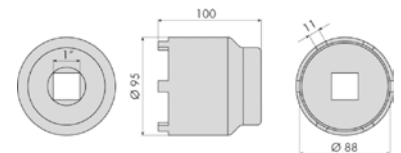

Suitable for Vario 814, Sprinter
616, Atego HL 2/43 DG6.2



TN



6 PIN REAR HUB SOCKETS MAN BUS
Ø110mm

OM 0300

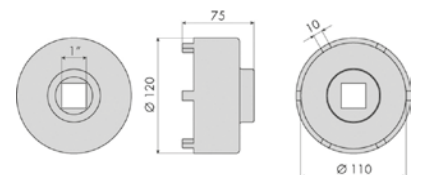



TN



6 PIN HUB SOCKET MAN & MERCEDES Ø117mm

OM 0322

Suitable for rear axles TGA

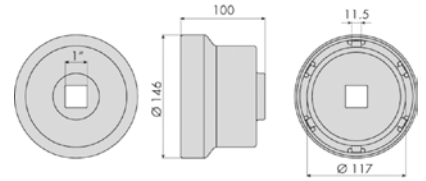

TN



6 PIN REAR AXLE NUT SOCKET MERCEDES/MAN Ø87mm

OM 0386

Suitable for Atego, Vitaro 814 and MAN rear axles.

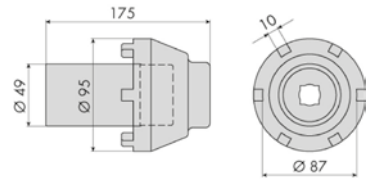

TN



6 PIN REAR AXLE NUT SOCKET MERCEDES/MAN Ø101mm

OM 0387

Suitable for Hypoid and trailer axle NR7/4, Omnibus 0305G, 0405G.

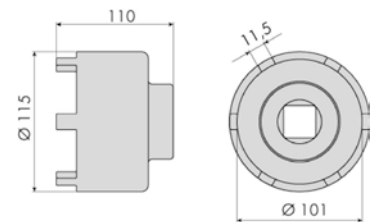

TN



6 PIN DRIVE AXLE NUT SOCKET MAN/MERCEDES Ø101.5mm

OM 0388

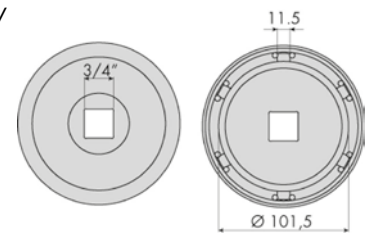

TN



12 & 6 PIN REVERSIBLE HUB SOCKET MAN/MERCEDES Ø102mm

OM 0321

For models prior to 7TN AL 7/1
For models before 10TN/13TN, HL 7/0, 7/1, 7/2, 7/3, 7/18, 7/015, 7/021, HO 7/8, 7/9, HD 7/2, 7/19DG, 7/016DG

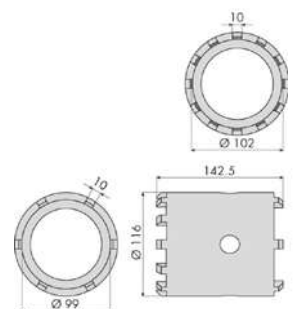



TN



6 PIN REAR HUB SOCKET
MERCEDES Ø71.5mm

OM 0307

Suitable for rear models HL 2/2, 2/7, 2/13

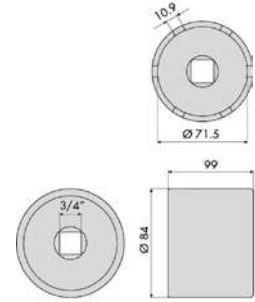

TN



6 PIN REAR HUB NUT SOCKET
MERCEDES Ø75mm

OM 0309

Suitable for front hubs AL 3/1, 3/2, 3/3, 3/4, 3/7, 3/8
For rear hubs HL 2/14, 2/30, KL 2/16, 4/1, 4/4, 4/8, 4/16,
4/17, 4/23, 4/28, 4/29, KD 4/6G, HO 4/2, 4/18, NR 4/4

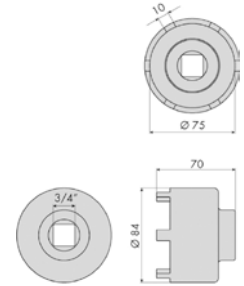

TN



12 PIN REAR HUB SOCKET
MERCEDES Ø90mm

OM 0305

Suitable for Mercedes Actros 1840, rear axle
BRG year 2001

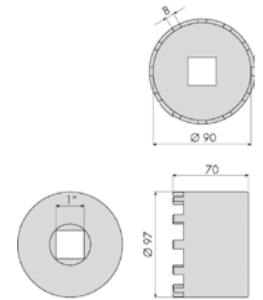

TN



6 PIN TRAILER HUB SOCKET
MERCEDES Ø113mm

OM 0308

Suitable for models NSA/2, NSA/10,
HL 6/1, 6/2, 6/3, HD 6/3

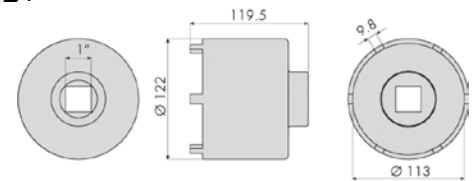

TN



6 PIN REAR AXLE NUT SOCKET
BENZ Ø116mm

OM 0385

Suitable for HL/HL8 Actros axles.





HUB• HUB SOCKETS

← FIND THE COMPLETE RANGE OF HUB SOCKETS HERE



6 PIN HUB SOCKET MERCEDES ATEGO Ø101mm

OM 0311

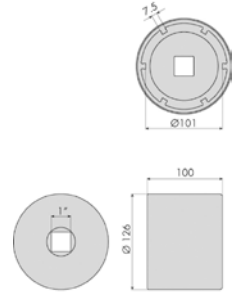

TN



HEX MERCEDES HUB SOCKET Ø95mm 1"

OM 0301

Suitable for axles and trailers

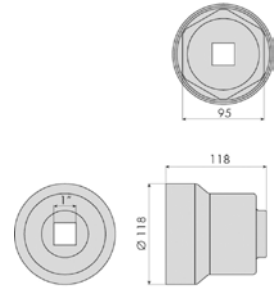

TN



6 PIN REAR HUB SOCKET MERCEDES Ø71.5mm

OM 0307

Suitable for rear models HL 2/2, 2/7, 2/13

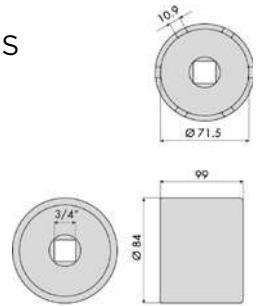

TN



RECTANGULAR HUB SOCKET FOR KASSBOHRER/SETRA/DAF/MERCEDES 56x71mm

OM 0312

Suitable for Kassbohrer/Setra:
Front axles 6.5T and 7.5T on S210, 215, SG 219-221
Rear axles type S216 HDS and S228 DT, 0303, 0305-G, 0307
Daf/Mercedes: VL 3/8, 3/13, 4/7, 4/9, 4/10, 4/15, 4/16, 4/19, VD 4/14, 4/20, type 363, 385, 387, 389, 391, 393, 395, 617, 620, 621, 622, 623, 625, 649
Mercedes-Autobus: VO 3/10, 4/11, 4/13, 4/19 type 0303, 0305-G and 0307

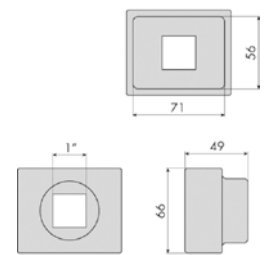

TN



HEXAGONAL SOCKET FOR MERCEDES/EVOBUS DIFFERENTIAL NUTS Ø72mm

OM 0350

Suitable for Mercedes Citaro et EvoBus, ZF axle 132





HEX HUB SOCKET IVECO Ø90mm
1" D.

TN

OM 0341

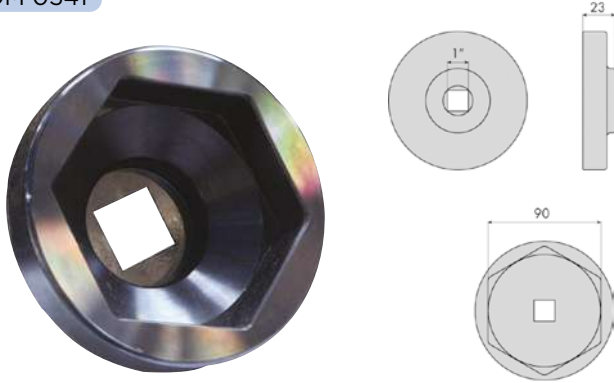

Suitable for Iveco Cargo HA>98



DOUBLE HEX HUB SOCKET IVECO Ø85mm

TN

OM 0331

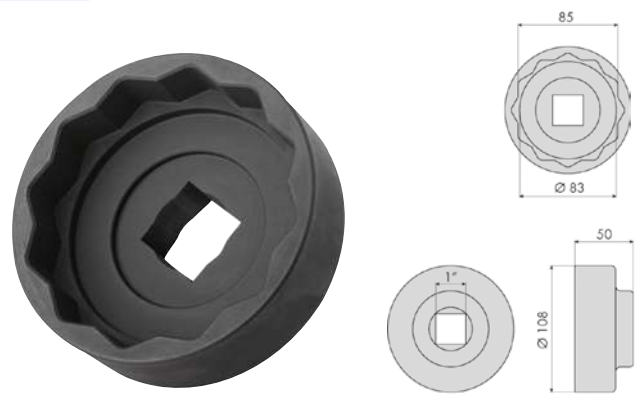

IVECO AXLE NUT SOCKET 98mm
HEX

TN

OM 0382



Suitable for Iveco Eurocargo



AXLE NUT SOCKET IVECO
110mm DOUBLE HEX

TN

OM 0383



Suitable for IVECO Eurotech Cursor HA.



SHAFT BEARING INSTALLATION
GUIDE IVECO DAILY

TN

OM 0479





8-SIDED FRONT HUB NUT SOCKET SCANIA Ø80mm 1"

OM 4480

Scania 124L, 144L, series 4<96

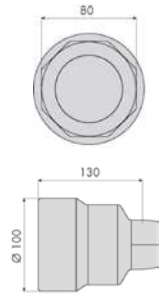

TN



4 PIN REAR AXLE SOCKET SCANIA Ø91mm

OM 0324

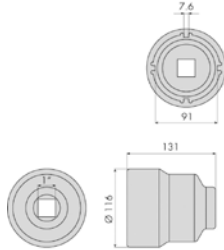

TN



HGV HUB SOCKET SCANIA 1"

OM 0404

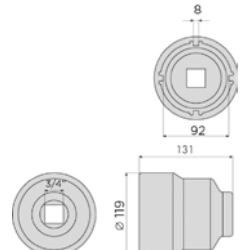

TN



8-SIDED REAR HUB NUT SOCKET SCANIA Ø100mm 3/4"

OM 4100

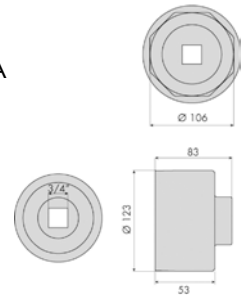

TN



4-PIN SCANIA TRANSMISSION SOCKET Ø63-64mm

OM 0351

Suitable for Scania 310, 320

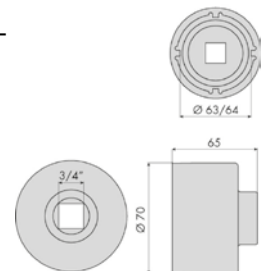

TN



GROOVE NUT SOCKET WITH 8 STUDS SCANIA 420 Ø103mm

OM 0389



Specific for SCANIA 420
Heavy duty tipper.

TN



3/4" 95mm OCTOGONAL SOCKET SCANIA 10 WHEELS

OM 0399



TN





TN



3/4" ROLLER BEARING AXLE NUT
SOCKET BPW 6.5/9T 65mm

OM 0370



HUB SOCKET BPW TRAILERS
6.5-9T

OM 0334

Suitable for axles 6.5-9T type H, R, N, ECO H/K/N, ECO-MAXX H/K/N, ECOPlus H, ECOPlus 2 H/KH

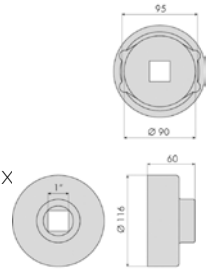

TN



HUB SOCKET BPW TRAILER 12T

OM 0335

Suitable for axles 12T type H, R, K, N, ECO H/KH/N, ECO-MAXX H/KH/N, ECOPlus H/KH

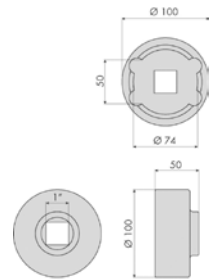

TN



3/4" ROLLER BEARING AXLE NUT
SOCKET BPW 12T 80mm

OM 0371



REAR HUBCAP NUT SOCKET
BPW 12T 109mm 8-SIDED

OM 0373

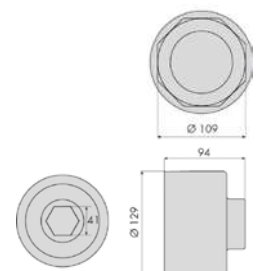

TN





HUB • HUB SOCKETS

← FIND THE COMPLETE RANGE OF HUB SOCKETS HERE



REAR HUBCAP NUT SOCKET BPW 12T 111mm

OM 0374

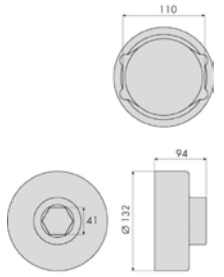

TN



3/4" ROLLER BEARING AXLE NUT SOCKET BPW 16T HEX

OM 0372

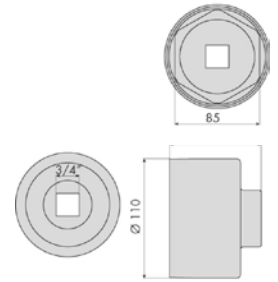

TN



REAR HUBCAP NUT SOCKET BPW 16T 110mm 8-SIDED

OM 0375

Suitable for the new BPW 16T axles

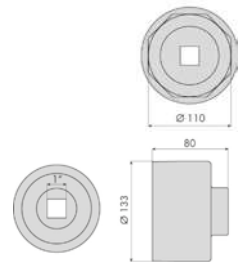

TN





HEX REVERSIBLE HUB SOCKET FRUEHAUF TRAILERS 123mm/110mm TN

OM 0333

Icons:

AXLE TRAILERS NUT SOCKET SAF 85mm HEX TN

OM 0376

Icons:

HEX HUB SOCKET RENAULT/SAF Ø140mm TN

OM 0332

Icons:

8-SIDED HUB SOCKET R.O.R TRAILERS 84mm TN

OM 0330

Icons:

8-SIDED HUB SOCKET R.O.R TRAILERS 127mm TN

OM 0329

Icons:

WHEEL CAPSULE AND AXLE NUT SOCKET 65mm 3/4" TN

OM 0377

WHEEL CAPSULE AND AXLE NUT SOCKET 80mm 3/4"

OM 0378

WHEEL CAPSULE AND AXLE NUT SOCKET 85mm 3/4"

OM 0379

WHEEL CAPSULE AND AXLE NUT SOCKET 111mm 3/4"

OM 0380

WHEEL CAPSULE AND AXLE NUT SOCKET 120mm 3/4"

OM 0381

Icons:

UNIVERSAL HGV HUB COVER REMOVAL TOOL 3/4" TN

OM 0355

Specifications:

- from Ø47mm to Ø145mm
- 3/4" D.
- 3 sets of pins for castle nuts

Icons:





HUB • HUB PULLER

← FIND THE COMPLETE RANGE OF HUB PULLER HERE



HUB PULLER



UNIVERSAL HGV HUB PULLER (5 ARMS)

OM 3455

Features:

- max. opening diameter: 425mm
- for nuts M14 to M22
- force up to 30T

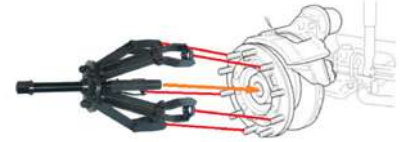

TN



MULTI-BRAND HUB PULLER (CARS & LCV)

OM 9208



Covers most light vehicles & vans (Jumpy, Iveco, Boxer, Master, Trafic, Ducato, Sprinter, Crafter...).

Contents:

- 4 extraction screws M12x1.5
- 4 extraction screws M14x1.5
- 1 mechanical spindle
- disc Ø90 to Ø130mm
- 4.3kg slide hammer



SA 9205	4 PCS WHEEL BOLT SYSTEM (MALE/FEMALE) M12x125
SA 9206	4 PCS WHEEL BOLT SYSTEM (MALE/MALE) M12x125
SA 9207	4 PCS WHEEL BOLT SYSTEM (MALE/FEMALE) M12x150-14x200

TN



FRONT WHEEL HUB REMOVER MAN Ø166mm

OM 0345



TN



10T HYDRAULIC DRIVE SHAFT PULLER SET

OH 5022



Use with 3,4 and 5 hole vehicle studs Ø16mm max. for hubs with Ø135 to Ø250mm.

TN



10T





TN

DUAL-CONTROL HYDRAULIC PRESS 50T SLIDING CYLINDER

OH 0951

+ Protective polycarbonate grille to shield the operator

Specifications:

- hydraulic pump
- manual override or hydropneumatic pedal
- chrome piston with adjusting screw
- sliding cylinder jack with handle and rating scale
- polycarbonate protection to protect the operator from splinters
- table height adjustable 12 positions
- winch-assisted up and down movement of the table
- 2 oversized pins to hold the table in place
- 226x136x55mm sliding drip tray
- large manometer
- reversible V-shaped support block, including punch kit and protective polycarbonate

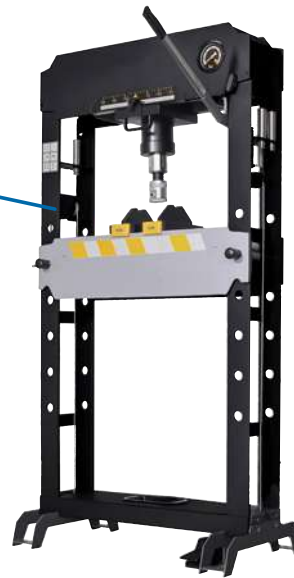

50T **5** WARRANTY

HYDROPNEUMATIC PRESS 100T

OH 0910



+ Protective polycarbonate screen to shield the operator

Specifications:

- hydraulic pump
- manual control or hydropneumatic pedal (dual pedal up and down)
- chrome plated piston with adjustment screw
- sliding cylinder with handle and positioning scale
- polycarbonate screen protection (5,5 cm) to protect the operator against possible splinters
- table height adjustable in 12 positions
- table raising/lowering assisted by winch
- table holding by 2 oversized pins
- large pressure gauge
- reversible V-shaped support block and plexiglass set included.



OH 0810	100T PUNCHER TOOLS	Accessory of OH 0910/OH 0921/OH 0931/OH 0951
OH 0851	50T PUNCHER TOOLS	Spare part of OH 0850

100T **5** WARRANTY



SWIVEL PRESS 100T+PUNCHES

OH 0570

Quick three-dimensional adjustment allowing use directly on vehicles.

Manivelle de levage du pivot

Verrouillage simple du pivot

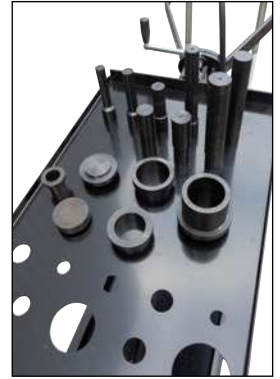

Inner press frame dimensions: 250x600mm



2 roues pivotantes freinées

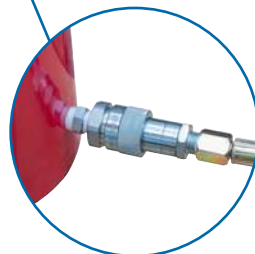

Raccord rapide Pression max 700bar

Pivot de retournement de la presse

Contents:

- 180° swivelling press on mobile trolley with handling handle
- hydropneumatic pump 700bar suitable for body repair/ lifting/extraction hydraulic rams
- flexible hose L. 200cm
- Punches:
 - Ø21,5x150mm
 - Ø24,5x150mm
 - Ø29x120mm
 - Ø29x220mm
 - Ø35x120mm

- Ø39x150mm
- Ø39x220mm
- MERCEDES ACTROS-SK-0404 ring
- reduction washer 35/25mm
- reduction washer 70/65mm



100T





GENERAL BEARING

BEARING INSTALLATION/ EXTRACTION KIT

TN

OM 3517BL



Contents:

- 9 adapters Ø55.5-59-62-65-66-71.5-73-78-84mm
- 3 races Ø76-86-91mm
- 3 thrust screws M12x1.25
- 3 thrust screws M12x1.5
- 3 thrust screws M14x1.5



SHAFT BEARING INSTALLATION GUIDE IVECO DAILY

TN

OM 0479



KNIVES + CLAWS SEPARATOR SET

TN

OM 5412BL



Contents:

- 1 separator knife mini 13mm maxi 63mm
- 1 separator knife mini 5mm maxi 65mm
- 2 arms for knives length 60mm
- 2 arms for knives length 80mm
- 2 arms for knives length 104mm
- 2 arms for knives length 128mm
- 2 claws 110mm
- 1 mount for arms/claws width 45-150mm
- 1 pull spindle L.170mm drive 17mm



HYDRAULIC GEAR PULLER SET 10T

TN

OM 3423

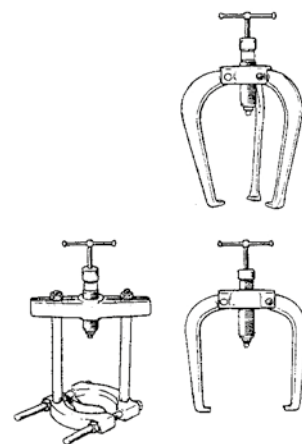

Contents:

- SA3423: 1 10T hydraulic jack
- 2 arm supports 2 and 3 claws
- 3 claws L.230mm
- 3 claws L.170mm
- 3 claws L.120mm
- 2 arms for knife L.180mm
- 2 arms for knife L.235mm
- 1 arm support max. width 160mm
- 1 separating knife, 20mm - 105mm capacity - bearing separator up to Ø105mm
- 1 centerer Ø25mm
- 1 L.50mm extension, head Ø16mm
- 1 extension length 100mm, head Ø16mm

10T



**BEARING EXTRACTOR SET INTERNAL GRIP Ø8-Ø58mm**

OM 3418



TN

Contents:

- SA3411: slide hammer 1kg L.280mm
- SA3412: coming soon
- SA3413: internal grip tip Ø8-11mm
- SA3414: internal grip tip Ø12-17mm
- SA3415: internal grip tip Ø18-23mm
- SA3416: internal grip tip Ø24-29mm
- SA3417: internal grip tip Ø30-34mm

- SA3418: internal grip tip Ø34-38mm
- SA3419: internal grip tip Ø39-43mm
- SA3425: internal grip tip Ø44-48mm
- SA3426: internal grip tip Ø49-53mm
- SA3427: internal grip tip Ø54-58mm
- SA3428: adapter M10x1.5
- SA3429: reducer M10x1.5-M8x1.25
- SA3430: reducer M10x1.5-M6x1.0

**BEARING EXTRACTOR SET INTERNAL GRIP Ø8-Ø32mm**

OM 3409



TN

Contents:

- SA3401: impact hammer 1kg L.380mm
- SA3402: 1 internal-grip tip Ø8mm to 10mm
- SA3403: 1 internal-grip tip Ø10mm to 12mm
- SA3404: 1 internal-grip tip Ø12mm to 14mm
- SA3405: 1 internal-grip tip Ø15mm to 17mm
- SA3406: 1 internal-grip tip Ø17mm to 20mm
- SA3407: 1 internal-grip tip Ø20mm to 24mm
- SA3408: 1 internal-grip tip Ø25mm to 29mm
- SA3409: 1 internal-grip tip Ø30mm to 32mm



+ Long-term protection

SUPER RELEASING GRAPHITE SPRAY 400ml

CO 1026

Thanks to its very low surface tension graphite formula, this super releasing spray penetrates deeply to erode rust, leaving a protective graphite film. Facilitates future removal.

Releases and protects, minimizes friction and stops rust.

Also available in box of 12



TN



CLUTCH

CLUTCH ASSEMBLY/DISASSEMBLY SET

OM 0639



Nowadays, vehicles are more frequently equipped with SAC clutches (Self Adjusting Clutch). These clutches are self-adjustable thanks to their automatic adjustment mechanism which balances the increasing loosening that comes about with wear of the clutch disc. This device ensures regular clutch strength over time and optimal comfort.

Care is required when assembling these clutches because it could deform the clutch mechanism bell cover or displace it if it is done incorrectly. To avoid these problems, the assembly/removal of SAC clutches must be carried out with a special tool.

Applications:

Covered the majority of the vehicles equipped of SAC clutches.

Supplied with Ø15.8mm new pin for PSA DV10 engines and with new pin for Puma and Opel engines.



CLUTCH ALIGNMENT TOOL

OM 0617

**Specifications:**

- length 150mm
- sockets Ø15-16-17-19-20-21-23-25mm



CLUTCH AXIS EXTRACTOR FIAT/PSA

OM 0618



For Fiat Ducato and Peugeot Boxer from 1994 with pull-type clutch. For extracting clutch stem to remove the transmission.



HGV CLUTCH ALIGNMENT TOOL

OM 0621

For accurate mouting, positioning and centric on single and double disc clutches.

**Contents:**

- 1 expanding guide from 36 to 48mm
- 1 expanding guide from 42 to 52mm
- 4 centering valves Ø20-25-27-30mm



**MINERAL/MULTIGRADE OIL ELECTRIC CLUTCH BLEEDER 5-20L 3.5bar**

HU 1108

**Specifications:**

- 220V power supply (5m cord)
- equipped with an on/off switch
- with pressure regulator 0-3.5bar
- pressure gauge for pressure control
- capacity 5 to 20 litres, allowing several operations
- flow rate: 40l/h
- interchangeable canister: ensures compatibility of the mineral/multigrade/pentosin liquid...
- flexible L.3,5m
- automatic triggering
- dimensions: 850x400x330mm
- weight: 22kg

Recommended for HPS-2 gearboxes and clutches with secondary expansion tank (Mercedes Actros MP-II, ATEGO, AXOR...).

HU 1117	HGV MAN TGA PLUG SET	Accessory of HU 1102/HU 1103
---------	----------------------	------------------------------

HU 1116	HGV MERCEDES PLUG SET	Accessory of HU 1103/HU 1102/HU 1101/HU 1108/HU 1121
---------	-----------------------	--





GEARBOX

Specially designed to remedy gearbox oil cooler failures that immobilize the vehicle, the radiator replacement is mounted instead of the defective radiator. It then allows a normal circulation of oil in the circuit. The vehicle can be driven back to the nearest garage.

GEARBOX OIL COOLER SUBSTITUTE DAF 105

OM 3970

GEARBOX OIL COOLER SUBSTITUTE DAF 95

OM 3971



TN

2 WARRANTY

GEARBOX REFILLING DEVICE WITH ADAPTERS

HU 8005

Pneumatic and manual pump for fluid refilling. Includes an adapter kit with various outlet angles: made for the poorly accessible areas.



SA8515: oil filling adapter set

Specifications:

- manual flow speed: 0.1l/pump
- pneumatic flow speed: 0.18 at 0.2l/sec
- maximum pressure: 7bar
- drain valve of tank: 1bar
- supplied with a set of 15 connectors
- graduated bowl
- 60 psi manometer
- transport handle
- 1/4 turn valve supply/drain
- offset filling plug



TN

2 WARRANTY

2 STAGE PIT JACK 800kg

OH 0236



2 WARRANTY

2 STAGE PIT JACK 1.5T

OH 0237



2 WARRANTY

Specifications:

- foot control
- chromed rod
- overload safety
- 4 swiveling wheels



REF	Capacité Capacity	A (mm)	B (mm)	C (mm)	Poids Weight
OH 0236	800kg	850	1870	480	49kg
OH 0237	1500kg	880	1900	700	58kg

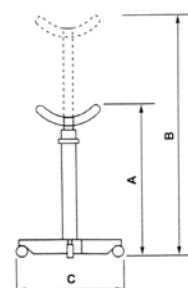



GEARBOX

← FIND THE COMPLETE RANGE OF GEARBOX HERE



PRIMARY SHAFT SUPPORT FOR ZF ECOSPLIT GEARBOX

TN

OM 0478



ZF 16 S 130
ZF 16 S 160
ZF 16 S 190
ZF 16 S 220
ZF 16 S 221

Engine codes:
1X56137122 /
99360515



SPLITTER ADJUSTMENT TOOL FOR ZF ECOSPLIT GEARBOX

TN

OM 0475



ZF16 GEARBOX BEARING PULLER

TN

OM 0460

Delivered with 5 sets of cups allowing the bearing to grip at the bar turning level, without risk of damage.



NEUTRAL POSITION ADJUSTMENT TOOL FOR ZF AS TRONIC GEARBOX

TN

OM 0462



DAF (Euro 3-4-5)



50 ml GEARBOX LEAK STOP

TN

CO 1016



Effectively stops gearbox oil leaks, protecting them against insufficient lubrication and possible breakage. Suitable for all types of manual gearboxes, transfer cases and differentials.

Specifications:

- revives seals and sealing rings
- reduces wear and tear
- ensures optimal lubrication
- prevents oil oxidation

Do not use for automatic transmissions and integrated oil bath clutches.

Also available in box of 24



300 ml ANTI-FRICTION ENGINE/GEARBOX

TN

CO 1017



Preventive and curative anti-friction for engines and gearboxes. Reduces friction and provides a wear-resistant coating for long engine life. Revives gaskets.

Dilution:

- engine: 6 to 7.5% (one bottle for 4 to 5L of engine oil)
- gearbox: 10% of the oil volume

Optimum efficiency after using the engine cleaner before draining (CO1015)

Also available in box of 24





TN

3 BEARING MOUNTING TUBES FOR ZF16 ECOSPLIT GEARBOX

OM 0470



OM0471 : 1 x tube de montage roulement boites zf16 ecosplit ø93x77mm
 OM0472 : 1 x tube de montage roulement boites zf16 ecosplit ø96x90mm
 OM0473 : 1 x tube de montage roulement boites zf16 ecosplit ø102x96mm



PRIMARY SHAFT SUPPORT FOR ZF ECOSPLIT GEARBOX

OM 0477



PRIMARY/SECONDARY SHAFT UNLOCKING TOOL FOR ZF16 ECOSPLIT GEARBOX

OM 0476



BEARING AND GEARWHEEL PULLER FOR ZF16 221-251 GEARBOX

OM 0461



Contents:

- 4 sets of cups
- 1 push screw with support pad
- removing body Ø286mm
- 3 sets of connecting sticks (L. 290-378-500mm)

Cup dimensions:

- 1 set Ø ext. 179mm and Ø inn. 98mm
- 1 set Ø ext. 261mm and Ø inn. 155mm
- 1 set Ø ext. 261mm and Ø inn. 189mm
- 1 set Ø ext. 282mm and Ø inn. 198mm





GEARBOX

← FIND THE COMPLETE RANGE OF GEARBOX HERE



INSTALLATION/REMOVAL PRIMARY SHAFT ZF AS TRONIC GEARBOX

TN

OM 0465



12 AS 2301 - 16 AS 2601

Engine codes:

1X56138216 / 1X56138234



FORK HOLDING TOOL FOR ZF AS TRONIC GEARBOX

TN

OM 0467



12 AS 2301 - 16 AS 2601

Engine codes:

1X56138197 / 99360527



BEARING PULLER FOR GEARBOXES ZF SET

TN

OM 3986



Puller + crankshaft for removing the gearbox bearing infeed for extractor.
For AS TRONIC 10-12-16-speed.



BEVEL BEARING GEAR PULLER FOR ZF AS TRONIC GEARBOXES

TN

OM 3980



For ZF Astronic 10-12-16 speed gearboxes.

Engine codes:

1X56122304 / 1X56136740





GEARBOX

← FIND THE COMPLETE RANGE OF GEARBOX HERE



MOVE/REMOVE HYDRAULIC KIT FOR VT VOLVO/ RENAULT GEARBOX SYNCHRO

OM 0562



Reversible through-cylinder 20T

Engine codes:
9992619 / 9992671 / 9994542 /
9996889 / 9998542 / 88800015



20T



TN

OIL DISTRIBUTOR REMOVAL WRENCH VT VOLVO/RENAULT GEARBOX

OM 0561



2 SPACER PLIERS GEARBOX COVER

OM 0560



OUTPUT FLANGE LOCKING TOOL FOR VOLVO/RENAULT GEARBOX

OM 0563





4-LUG SOCKET 1" FOR INTERNAL NUT SCANIA BOX

TN

OM 0515



4-LUG SOCKET 1/2" FOR DELAYING SCANIA (TYPE 1)

TN

OM 0511



4-LUG SOCKET 1/2" FOR DELAYING SCANIA (TYPE 2)

TN

OM 0512



SET OF TOOLS GASKET INSTALLATION DELAY TIME SCANIA (TYPE 2)

TN

OM 0556



4-LUG THIN SOCKET 3/4" FOR SCANIA GEARBOXES WITH DELAYER

TN

OM 0513



For gearboxes:
GR801-GR900
GRS890-GRS900-GRS920
GRSH900
GRSO900



4-LUG SOCKET 3/4" FOR SCANIA GEARBOXES WITHOUT DELAYER

TN

OM 0514



For gearboxes:
GR801-GR900
GRS890-GRS900-GRS920
GRSH900
GRSO900
Also suitable for transmissions





CALAGE & DISTRIBUTION RENAULT/VOLVO

FLYWHEEL ROTATOR TOOL FOR RENAULT MAGNUM ENGINES

OM 0328



TN

FLYWHEEL ROTATOR TOOL FOR RENAULT/VOLVO ENGINES

OM 0327



TN

Suitable for engines: D11, D13, D16 (FH,D13a 520) (2008-2018) and Mack MP7, MP8, MP10 (2008-2018)
OEM codes : 88800014

FLYWHEEL ROTATOR TOOL FOR VOLVO ENGINES

OM 0325



TN

6 or 12 cylinder Volvo D9A, D12, D16C engines.

OEM codes : 9998068

FLYWHEEL ROTATOR TOOL FOR RENAULT/VOLVO ENGINES

OM 0326



TN

Suitable for DXI 11 engines

OEM codes : 9996956 , 6956

INSTALLATION AND REMOVAL ROCKER ARM RAMP TOOL RENAULT/VOLVO 9-12-16L

OM 0150



OEM codes : 9990185



TN

CABIN SHOCK ABSORBERS ASSEMBLY/ DISASSEMBLY PACK

OM 3685



TN

MOUNTING GUIDE CYLINDER SET VOLVO/ RENAULT 11-12-13-16L

OM 0112



TN

OEM codes : 9998318 , 9998389 , 9998601



TN

MASTER TIMING TOOL SET
RENAULT/NISSAN/OPEL/VOLVO
GENERATION 1

OM 6100



Engine codes:

D4F702, D4F706, D4F708, D4F712, D4F714, D4F716, D4F722, D4F728, D4F730, D4F740, D4F764, D7F700, D7F701, D7F710, D7F720, D7F722, D7F726, D7F730, D7F744, D7F746, D7F764, D7F766, E5F, E6J, E7F700, E7F704, E7F706, E7F750, E7J601, E7J624, E7J626, E7J634, E7J635, E7J680, E7J700, E7J706, E7J710, E7J711, E7J716, E7J718, E7J719, E7J720, E7J724, E7J726, E7J728, E7J740, E7J742, E7J745, E7J754, E7J756, E7J757, E7J764, E7J770, E7J771, E7J773, E7J780, FIN, F2N, F2R, F3N, F3P, F3P670, F3P682, F3P700, F3P704, F3P706, F3P708, F3P710, F3P712, F3P714, F3P720, F3P724, F3P755, F3P758, F3P760, F3R, F3R611, F3R722, F3R723, F3R728, F3R729, F3R750, F3R751, F3R752, F3R754, F3R791, F3R796, F3R797, F3R798, F4P, F4R, F5R700, F5R701, F5R740, F7P704, F7P722, F7R710, F7R714, F8M736, F8M760, F8Q600, F8Q606, F8Q610, F8Q620, F8Q622, F8Q624, F8Q630, F8Q632, F8Q640, F8Q644, F8Q646, F8Q648, F8Q662, F8Q672, F8Q678, F8Q680, F8Q682, F8Q684, F8Q692, F8Q696, F8Q706, F8Q714, F8Q720, F8Q722, F8Q730, F8Q732, F8Q740, F8Q742, F8Q744, F8Q764, F8Q768, F8Q776, F8Q784, F8Q786, F8Q788, F9Q610, F9Q650, F9Q664, F9Q670, F9Q674, F9Q71, F9Q716, F9Q717, F9Q718, F9Q720, F9Q722, F9Q730, F9Q731, F9Q732, F9Q733, F9Q734, F9Q736, F9Q738, F9Q740, F9Q744, F9Q748, F9Q750, F9Q752, F9Q754, F9Q758, F9Q759, F9Q760, F9Q762, F9Q768, F9Q770, F9Q772, F9Q774, F9Q780, F9Q782, F9Q784, F9Q786, F9Q788, F9Q790, F9Q796, F9Q800, F9Q803, F9Q804, F9Q808, F9Q812, F9Q816, F9Q818, F9Q820, G8T714, G8T716, G8T740, G8T752, G8T760, G8T790, G8T792, G8T794, G9T600, G9T605, G9T700, G9T702, G9T703, G9T706, G9T707, G9T710, G9T712, G9T720, G9T722, G9T742, G9T743, G9T750, G9U720, G9U724, G9U726, G9U730, G9U750, G9U754, J5T, J6RJ7R, J7R732, J7R733, J7R734, J7R735, J7R768, J7T600, J7T760, J7T761, J7T762, J7T766, J7T772, J7T780, J7T782, J8S620, J8S621, J8S622, J8S758, J8S760, J8S776, J8S778, K4J700, K4J710, K4J711, K4J712, K4J713, K4J714, K4J715, K4J730, K4J732, K4J740, K4J750, K4J770, K4J780, K4M700, K4M701, K4M704, K4M706, K4M707, K4M708, K4M709, K4M710, K4M711, K4M712, K4M714, K4M716, K4M718, K4M720, K4M724, K4M730, K4M732, K4M734, K4M736, K4M740, K4M742, K4M743, K4M744, K4M745, K4M746, K4M748, K4M750, K4M752, K4M753, K4M754, K4M760, K4M761, K4M762, K4M764, K4M765, K4M766, K4M768, K4M776, K4M782, K4M788, K4M790, K4M791, K4M794, K4M800, K4M801, K4M802, K4M804, K4M812, K4M813, K4M830, K7M, K9K700, K9K702, K9K704, K9K706, K9K710, K9K712, K9K714, K9K716, K9K718, K9K722, K9K724, K9K728, K9K729, K9K732, K9K734, K9K750, K9K752, K9K760, K9K762, K9K764, K9K766, K9K768, K9K790, K9K792, K9K830, K9K832, K9K834, K9K836, N7Q704, N7Q710, N7Q711, N7U700, N7U701, S8U720, S8U722, S8U730, S8U731, S8U742, S8U748, S8U750, S8U752, S8U770, S8U772, S8U780, S8U782, S9U700, S9U702, S9U704, S9U714, S9U740, S9W206, S9W208, S9W212, S9W700, S9W702



Models:

Renault: Clio 1-2-3-4, Clio Sport 1-2-3, Mégane 1-2-3, Master 1-2, Mégane Scénic 1-2-3, Vel Satis 1-2, Avantime, Kangoo 1-2-3, Laguna 1-2-3, Espace 1-2-3, Trafic 1-2, Wind, Modus, Twingo, Koleos
Dacia: Logan, Duster, Sandero, Dokker
Nissan: Note, Qashqai, Micra, Interstar, Primastar, Kubistar, Almera, Primera
Opel: Vivaro, Movano
Volvo: S 40, V 40
Engines: 1.2, 1.2 16V, 1.4, 1.4 16V, 1.5 DCI, 1.6, 1.6 16V, 1.6 D, 1.7, 1.8, 1.8 16V, 1.9 TD, 1.9, 1.9 DCI, 1.9 DTI, 1.9 CDTI, 2.0, 2.0 16V, 2.1 TD, 2.2, 2.2 DCI, 2.2 DTI, 2.2 TD, 2.5 DCI, 2.5 CDTI, 2.5 TD, 2.8 D

OEM codes :

KM-6031, KM-6203, KM-6204, KM-6205, KM-6234, KV113 B0130, KV113 B0280, KV113 B0360, MOT 1054, MOT 1135-01, MOT 1200-01, MOT 1312, MOT 1318, MOT 1337, MOT 1340, MOT 1348, MOT 1384, MOT 1386, MOT 1489, MOT 1490-01, MOT 1496, MOT 1534, MOT 1536, MOT 1537, MOT 1538, MOT 1543, MOT 1750, MOT 910, K9K



TIMING TOOLS RENAULT/
OPEL/NISSAN/SUZUKI DCI

OM 3674

Models:

Renault: Clio, Kangoo, Laguna, Espace, Master, Mégane/Scénic, Trafic
Nissan: Kubistar, Interstar, Qashqai
Opel: Vivaro, Movano
Suzuki: Grand Vitara

Engines: 1.5 DCI, 1.9 TD, 1.9 DCI, 2.2 DCI, 2.5 DCI



Engine codes:

F9Q650, F9Q660, F9Q664, F9Q670, F9Q674, F9Q680, F9Q690, F9Q740, F9Q746, G9T, G9U, K9K700, K9K702, K9K704, K9K706, K9K710, K9K712, K9K714, K9K716, K9K718, K9K722, K9K724, K9K728, K9K729, K9K718, K9K722, K9K724, K9K728, K9K729, K9K732, K9K734, K9K764, K9K766, K9K768, K9K790, K9K792, K9K830, K9K832, K9K834, K9K836

OEM codes :

KM-6031, KM-6203, KM-6204, KM-6205, KM-6234, KV113 B0130, KV113 B0280, KV113 B0360, MOT 1054, MOT 1200-01, MOT 1489, MOT 1534, MOT 1536, MOT 1537, MOT 1543, MOT 910



TIMING TOOL RENAULT/NISSAN/OPEL 1.6-
2.0-2.3 DCI-CDTI

OM 3686



Models:

Fiat: Talento 2
Renault: Megane, Scenic, Laguna, Latitude, Fluence, Espace, Trafic, Koleos, Vel Satis
Nissan: Primastar, Qashqai, X-trail, NV 400
Opel: Vivaro, Movano
Mercedes: C180

Engines:

1.6, 2.0, 2.3 DCI et CDTI





IVECO

TN



GEARBOX AND DISTRIBUTION SHAFT MOUNTING GAUGE IVECO 10L

OM 0157

OEM codes :
99395218



GEARBOX AND DISTRIBUTION SHAFT MOUNTING GAUGE IVECO 13L

OM 0158

OEM codes :
99395219



TN

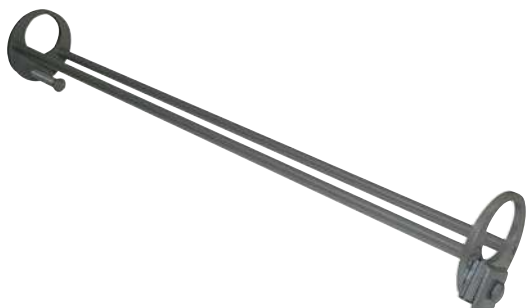

INSTALLATION AND REMOVAL ROCKER ARM RAMP TOOL IVECO 8L

OM 0151

OEM codes :
99360558



TN



INSTALLATION AND REMOVAL ROCKER ARM RAMP TOOL IVECO 10-13L

OM 0152

OEM codes :
99360553



FLYWHEEL ROTATOR TOOL FOR IVECO ENGINES

OM 0339



Suitable for 8360.46/F3A/F3B engines
Specific for Eurocargo/Cargo 150E27R/FPR
320E27T/PT Eurotech/Eurostar



FLYWHEEL ROTATOR TOOL FOR IVECO ENGINES

OM 0340



Engines 8040-25-45/9060-25-45/8210.42/8260/8280/190.38/190.42
Specific for Eurocargo/Cargo /Eurotech/
Heavyon/OffRoad/Bus





TN



TIMING TOOLS FIAT 2.3 JTD

OM 4025

Applications:

Brands: FIAT, IVECO

Models: Ducato, daily

Engines: 2.3 JTD, 3.0 JTD, 3.0 HPI

Engine codes:

F1AE0481C, F1CE0481D, F1AE0481A, F1AE0481B, F1AE0481N,
F1CE0481A, F1AGL411B, F1AGL411C, F1AE341D

OEM codes :

1860617000, 2.000018200, 99360614, 99360615

CRANKSHAFT FRONT SEAL INSTALLATION
TOOL IVECO/ASTRA 10-11-13-16L

TN

OM 0521

**Specifications:**

- seal (MVQ) silicone rubber
- Øext. 130mm
- Øinn. 100mm
- thickness 12mm

Engines: F3A/F3BModels: IVECO Eurostar, Eurotech MP,
Eurotrakker, Stralis, Trakker, ASTRA HD7-C
and HD8CRANKSHAFT REAR SEAL
INSTALLATION TOOL
IVECO/ASTRA 10-13L

TN

OM 0522

CRANKSHAFT REAR SEAL
INSTALLATION TOOL
IVECO EUROCARGO 1-3

TN

OM 0525

Specifications:

- PTFE seal
- Øext. 155mm
- Øinn. 130mm
- thickness 16mm

Engines: F4A, N40, N45, N60**Models:** IVECO Eurocargo 1-3,
Eurofire, Tector, VertisCRANKSHAFT FRONT SEAL INSTALLATION TOOL
IVECO STRALIS 10L (F2C)

TN

OM 0523

**Specifications:**

- FPM seal (fluor rubber)
- Øext. 160mm
- Øinn. 130mm
- thickness 14mm

Engines: F3A/F3B/F2C**Models:** IVECO Eurostar, Eurotech MP, Eurotrakker,
Stralis, Trakker, ASTRA HD7-C and HD8CRANKSHAFT REAR SEAL INSTALLATION
TOOL IVECO DAILY/FIAT DUCATO

TN

OM 0527

- Dimensions:
- Øext. 113mm
 - Øinn. 83mm
 - thickness 14mm

Engine: F1A 2.3l

IVECO AIR-CONDITIONING ELASTIC BELT
MOUNTING TOOL

TN

OM 4052

Requires a second operator to
rotate the engine.**Applications:** IVECO
Cursor



SCANIA

TN



CRANKSHAFT REAR SEAL INSTALLATION TOOL SCANIA Ø175mm

OM 0492

Engines: 8.9I PDE, 9.3I PDE, 10.6I PDE, 11.7I PDE, 11.7I HPI, 15.6I PDE, serie 4, serie S, serie 520
For seal ref OEM 1433183

CRANKSHAFT REAR SEAL INSTALLATION TOOL SCANIA Ø175-185mm

OM 0494

Engines: 8.9I PDE, 9.3I PDE, 10.6I PDE, 11.7I PDE, 11.7I HPI, 15.6I PDE
OEM ref for seal Ø175: 1433183

CRANKSHAFT REAR SEAL INSTALLATION TOOL SCANIA Ø185mm

OM 0493

Engines: 8.9I PDE, 9.3I PDE, 10.6I PDE, 11.7I HPI, 15.6I PDE

For seal inner Ø 145mm



CRANKSHAFT SEAL INSTALLATION RING SCANIA

OM 0499



Engines: 9-11-12I
Injection PDE/HPI



TN

CRANKSHAFT REAR SEAL INSTALLATION TOOL SCANIA Ø185mm

OM 0484



Engines: 8.9I PDE, 9.3I PDE, 9.3I XPI, 12.7I XPI, 15.6I PDE, 16.4I XPI

For seal inner Ø 155mm



TN

CRANKSHAFT FRONT SEAL INSTALLATION TOOL SCANIA 12L Ø119

OM 0491



Engine: 11.7I



TN



CRANKSHAFT FRONT SEAL INSTALLATION TOOL SCANIA 9-13L Ø119mm

TN

OM 0481



Engines: 12,7I XPI



CRANKSHAFT FRONT SEAL INSTALLATION TOOL SCANIA Ø149mm

TN

OM 0482



Engines: 12,7I XPI second generation



CRANKSHAFT FRONT SEAL INSTALLATION TOOL SCANIA Ø119-138mm

TN

OM 0483



Engines: 15,6I PDE, 16,4I XPI second generation



DPF ASSEMBLY/DISASSEMBLY SCANIA

OM 7051

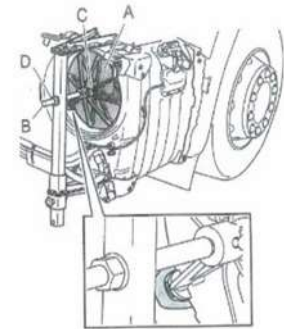
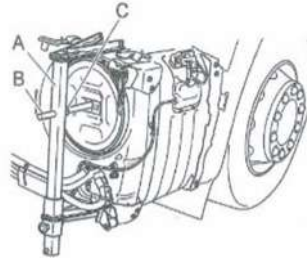

TN



DOUBLE FAP SCANIA MOUNTING/DISMOUNTING TOOL

TN

OM 7052



HGV BATTERY/CATALYTIC CRANE

TN

OH 8005



Specifications:

- Max. load: 90kg
- 4 wheels including 2 brake swivelling wheels
- lifting height: 1890mm





DAF

CRANKSHAFT FRONT SEAL INSTALLATION TOOL DAF

TN

OM 0531



Dimensions:
• Øext. 180mm
• Øinn. 154mm
• thickness 12mm

Models: DAF 75, 85, 95 CF/XF
OEM code seals: 0681704 - 682961 - 1457021 -
681704 - 1370127 - 1275083



ENGINE CRANK ROTATOR TOOL DAF

TN

OM 0347



Suitable for DAF XF 105, Euro5.



GEARBOX OIL COOLER SUBSTITUTE DAF 105

TN

OM 3970

Specially designed to remedy gearbox oil cooler failures that immobilize the vehicle, the radiator replacement is mounted instead of the defective radiator. It then allows a normal circulation of oil in the circuit. The vehicle can be driven back to the nearest garage.



GEARBOX OIL COOLER SUBSTITUTE DAF 95

TN

OM 3971

Specially designed to remedy gearbox oil cooler failures that immobilize the vehicle, the radiator replacement is mounted instead of the defective radiator. It then allows a normal circulation of oil in the circuit. The vehicle can be driven back to the nearest garage.





MERCEDES/MAN

FLYWHEEL ROTATOR TOOL FOR ACTROS/ATEGO/MAN ENGINES

OM 0304



Suitable for Actros/Atego
Mercedes 900, 904, 906
Man 5, 6, 8 cylinder engines,
D25/D28



TN

FLYWHEEL ROTATION TOOL 9 TEETH MAN / MERCEDES

OM 0348



Suitable for Euro 5-6 D20, D25, D26,
D28: 6, 8, 10, 12 cylinders



TN

FLYWHEEL ROTATOR TOOL FOR MERCEDES/MAN ENGINES

OM 0302



2 gears
Suitable for Actros 6,8,10 cylinder engines
Mercedes 400, 401, 402, 403, 404, 407, 409H/HA,
421, 424, 441, 444A/LA, 427, 4289, 447H/HA
Man 12 cylinder engines



TN

ADJUSTMENT KIT VAG 2.5 PD TDI

OM 4055



Models: Touareg, Transporter
Engines: 2.5 TDI PD

Engine codes:
AXD , AXE , BAC , BLJ , BLK , BNZ , BPC , BPD , BPE



TN



LIEBHERR ENGINE ROTATION TOOL

OM 0366



TN



SEAL TOOL KIT 24PCS

OM 5038

This kit allows the SPI seals to be replaced with diameters of Ø21.5 to Ø64mm.
 Removal: compact puller with unique extracting hooks, quick removal without any damaging.
 Installation: the interchangeable seal mandrels mean that the seal can be guided back into place for perfect positioning.
 2 pairs of claws L.70 and L.115mm for increased polyvalence.



TN



SA 5038 HOOK KIT L.70 and 115mm



HOOK SET FOR JOINTS (4 PCS)

OM 9216



TN





ACCESSORY BELT

FREEWHEELING ALTERNATOR PULLEY DISMANTLING KIT (30 PCS)

TN

OM 3789

Series of sleeves and locknuts, allowing the disassembly of the disengageable alternator pulley (dismantled or directly on the vehicle).



+ Compatible with 1.6 HDI and TDCI PSA/FORD

Applications: Renault, Peugeot, Citroën, VAG, BMW, Mercedes, Opel, Ford, Fiat, Toyota, Honda, Porsche...



UNIVERSAL BELT PULLEY PULLER QUICK APPROACH Ø47-110mm

TN

OM 4044



For the extraction of camshaft pulleys 2,3,4,6 and 9 arms. Also suitable for crankshaft pulleys/damper pulleys with threads in M8x1.25 and M10x1.5 and some flywheels.

Delivered with:

- claw set 1.5DCI (SA4046)
- claw set M8x1.25 L. 50mm
- claw set M10x1.5 L. 50mm





SPARK & GLOW PLUG REPLACEMENTS

VIBRATION GLOW PLUG REMOVAL KIT 1/4"

TN

OP 1404

Allows the glow plugs to be removed in a progressive, controlled and secure manner. Reduces the risk that the electrode may break within the glow plug's housing.



Contents:

- SA1404: vibration socket 1/4"
- SA1408: vibration socket 8mm
- SA1409: vibration socket 9mm
- SA1410: vibration socket 10mm
- SA1411: vibration socket 11mm
- SA1412: vibration socket 12mm
- SA1413: vibration extension 50mm
- SA1414: vibration extension 100mm
- SA1415: 1/4" universal joint for vibration socket

4 torque settings: 10-20-30 or 40Nm
Drive: 1/4"

+ Reduces the risk of breaking



3/8" PLUG WRENCH KIT Ø8-9-10-12-14-16mm

TN

OM 9213

Friction CV joint that leaves it in the ideal position
Plug retention gasket.





SPARK & GLOW PLUG PULLER

SPARK & GLOW PLUG THREAD REPAIRING

DIESEL UNIVERSAL GLOW PLUG EXTRACTOR

TN

OM 3788

Minimum space required for use: Ideal when the glow plug compartment is difficult to access.

Can be used in narrow engine compartments and with glow plugs on the firewall side.

Supplied with 3 hexagonal drive taps with easy centering, for thread repair.



Contents:

- SA3801: electrode extractor
- SA3802: reinforced electrode drill bit
- SA5328: 2 electrode drilling guides
- SA3803: 6.8mm stepped drill bit
- SA3804: 8.8mm stepped drill bit
- SA3805: drill bit holder
- SA3809: extraction tap
- SA3810: inertia extractor
- SA3811: M8 hexagonal drive repair tap
- SA3812: M10x100 hexagonal drive repair tap
- SA3813: repair tap M10x125 hexagonal drive



GLOW PLUG REPAIR KIT M8x100 M10x100 M10x125 M12x125

TN

OM 3787



Contents:

- 6 repair taps (M8x100-M10x100-M10x125-M12x100-12x125-M14x125)
- 2 insertion tools
- 3 plug well plugs
- SA3785: 5 inserts M8x100
- SA3786: 5 inserts M10x100
- SA3787: 5 inserts M10x125
- SA3788: 5 inserts M12x125



INJECTOR SYSTEM DIAGNOSTICS

600bar PUMP FOR INJECTOR CALIBRATION

AC 4012



To check the diesel injectors: blocked openings, pressure and shape of jets.

Pump supply lines supplied with connections Ø12-14mm and manometer (1/2 thread in 1.75mm).

Guarantee: never use this pump with diesel oil (risk of deterioration). Use the pump with bench oil (currently unavailable) and a steam vacuum.



AC 4023 CALIBRATION PUMP ADAPTER M31x100

TN

DIESEL STEAM CLEANER

AC 4015



Improves visual trials of injectors and vacuum any spray.

Specifications:

- clip to hold the injector in place
- vacuum by compressed air
- device that preserves user's health

Calibration pump not included



TN

ULTRASONIC CLEANER 9L 200W 40KHZ

OE 7201



Specifications:

- heating temperature adjustable from 0 to 80°C
- timer from 1 to 99 minutes
- power: 200W
- digital display
- tank drain valve
- tank capacity: 9l
- external dimensions: 330x310x270mm
- tray dimensions: 300x240x150mm



TN

ULTRASONIC CLEANER 3L 100W 40KHZ

OE 7200



Specifications:

- heating temperature adjustable from 0 to 80°C
- timer from 1 to 99 minutes
- ultrasonic power: 100W
- heating power: 100W
- digital display
- tank drain valve
- tank capacity: 3L
- tray dimensions: 240x140x100mm
- external dimensions: 270x240x170mm



SA 7070 TUB OF ULTRASOUND CLEANING SOLUTION CONCENTRATE 25% 2L



TN

8-CYLINDER COMMON RAIL INJECTOR TESTER

AC 5280

Covers the majority of vehicles with Bosch Common Rail injectors (excluding Opel), Denso, Delphi and Siemens. This composition allows to detect problems of injector flow rate.

Adapters for Bosch, Delphi and Denso injectors.



A) The engine runs without starting.
The placement of the graduated pencils allows you to diagnose:

- if all levels are similar: The injectors are working properly.
- if one level is found to be significantly higher than the others (25%), this injector is damaged

The method is faster:

- direct connection to the injector
- the fuel penetrates directly into the rods.

B) The engine starts.
The use of vials is recommended.
If an excessive flow is found in one of the vials, replace the injector connected to this vial.



SA 5240	6 CRAYON SET
SA 5242	24 CONNECTOR SET
SA 5281	SET OF 8 VIALS + HOLDER + HOSES



TN



+ Foaming penetrating formula, dissolves calamine and soot.

INJECTOR/GLOW PLUG RELEASER 500ml

CO 1025

Accessory of OP 9210/OM 0020BL/OM 4222/OM 5400/OM 9324/OH 0025/OH 0027/OM 0070/OM 0071/OM 0075/OM 4022/OM 4202/OM 5310/OM 9236/OM 9237/OM 9242/OM 9250/OM 9261/OM 9275/OM 9276/OM 9280/OM 9366/SA 4023/SA 4024/SA 9276/OM 5080/OM 5081/OM 5082/OM 5083/OM 5084/SA 5082/CO 0530/CO 0531/CO 0532/CO 0533/CO 0534/CO 0535/CO 0536/CO 0538/CO 0539/CO 0540/OM 3780/OM 3783/AC 2024/OM 0018/OM 3768/OM 3769/OM 3770/OM 3778/OM 3782/OM 3787/OM 9077/OM 9103/OM 9213/OM 9256/OM 9262/OM 9286/OM 9299/OP 1404/OM 3784/OM 0225/OM 3790/SA 3782/OM 0214/OM 0114/OM 0216/OM 0116/OM 0217/OM 0117/OM 0218

Allows injectors and glow plugs which have seized up due to calamine and soot to be released. Can also be used to clean turbos, EGR valves and exhausts.

Also available in box of 12





INJECTORS PULLER

LCV/HGV INJECTOR-HOLDER REMOVAL WRENCH

TN

OM 9261

Set of 4 pins sockets for the removal of injector holders on some commercial vehicles and HGVs.

- 1/2" D. 4 pin socket L.72mm: Mercedes OM Series 401/421, 403/423, LA, A, 470
- 32mm D. 4 pin socket L.70mm: Mercedes, Neoplan, Setra
- 1/2" D. 3 pin split socket L.120mm: Mercedes, MAN
- 32mm D. 4 pin socket L.120mm: MAN, Mercedes



1/2" D. SOCKET SET FOR INSTALLING/REMOVING INJECTOR HOLDERS

TN

OM 0070



Contents:

- SA0081: 1x22mm hex socket L.110mm with window
- SA0082: 1x22mm double hex socket L.78mm with window
- SA0083: 1x27mm double hex socket L.78mm with window
- SA0084: 1x28mm double hex wrench L.78mm with window



1/2" D. HEX SOCKETS SET FOR REMOVING DIESEL INJECTORS HEADS

TN

OM 0071



Contents:

- SA0011: 1/2" D. split socket 25mm
- SA0781: 1/2" D. split socket 27mm
- SA0012: 1/2" D. split socket 29mm
- SA0014: 1/2" D. split socket 30mm



DIESEL INJECTOR LINE SOCKETS 1/2" DOUBLE HEX Ø12-14-16-17-18-19mm

TN

OM 0080



1/2" D. 58T PRE-CHAMBER SOCKET DIESEL ENGINES

TN

OM 6058



Suitable for diesel engines Opel 2.0DI, 2.2 DI with OEM codes X20DTL, X20DTH, X22DTH, Mercedes CDI, 601, 602, 603, 605, 606, 661, 662





TN

SLIDE HAMMER 7.5kg

OM 4033

Designed to furnish high impact forces, it is used by placing both hands on the sliding weight.

Shaft threaded at both ends 5/18" UNF thread at one end and metric M18x1.5 at the other making it compatible with injector adapters, hub extractors, etc.



Specifications:

- total length 765mm
- shaft length 660mm
- weight of inertial extractor: 7.5kg
- double threaded shaft to suit adapters: 5/18" UNF



INJECTOR ADAPTER M18x1.5

TN

OM 4224

Accessory of OM 4033/OM 4222/OM 0022

This ball joint was designed for inertial weight OM 4022 and OM 4033 for injectors that have seized up or blocked, facilitating the access to the extractor on vehicles where this is not difficult to access.

Examples: Espace, Scénic, C4 Picasso... with advanced windscreen bay.



ELECTRODE REMOVAL WRENCH 1/2"

TN

OM 9277

Spare part of OH 0027/OM 5310

Allows you to remove the internal electrode of Bosch common rail injectors



Hex 10mm



ADAPTERS FOR BOSCH AND DELPHI INJECTORS

TN

OM 4202

Contents:

- bosch Adapter M20xM17x1.0
- delphi adapter M20xM14x1.5
- electrode removal wrench hex Ø10mm
- reducer M20x5/8" UNF





INERTIAL INJECTOR EXTRACTOR BOSCH/DELPHI

OM 4022

Allows fast and effortless extraction of the blocked injectors in the cylinder head.



SA 9026	FORK Ø16mm FOR EXTRACTOR
SA 4026	ADAPTER M18x1.5-M22x1.5
SA 4023	EXTERNAL GRIP ADAPTER BOSCH INJECTORS
SA 4027	INERTIAL INJECTORS ADAPTER BOSCH

- Contents:**
- slide hammer 3.5kg
 - inertial extraction rod M18x1.5 L.280mm
 - inertial extraction rod M18x1.5 L.360mm
 - SA9026: fork 16mm for extractor
 - SA4222: adapter M18-M20x1.5
 - SA4026: adapter M18-M22x1.5
 - SA4027: inertial adapter Bosch injectors



INJECTOR EXTRACTION LEVER M12x1.00 MALE

OM 5084

Accessory of OM 5081/OM 5085/SA 5080/SA 5083/OM 5083



- allows the injector to be unblocked.
- screws onto the connector to the fuel supply line.
- no injector disassembly required, can be reused if still functional.

For Bosch / Delphi (M12x1.00) / Denso / Siemens injectors



INJECTOR EXTRACTION LEVER M12x1.5 FEMALE

OM 5083

Accessory of OM 5081/OM 5085/SA 5083/SA 5080/OM 5084



- allows the injector to be unblocked.
- screws onto the connector to the fuel supply line.
- no injector disassembly required, can be reused if still functional.

For Bosch / Delphi (M12x1.5) / Denso / Siemens injectors



9KG INERTIAL MASS WITH SHOCK ABSORPTION

OM 0022

Accessory of OM 0199/OM 9208

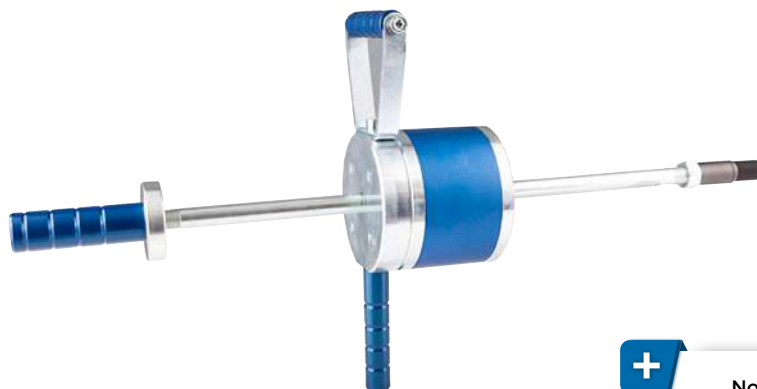

+ No bounce

- Specifications:**
- weight 9 Kg
 - total length 770 mm
 - adapter thread M18 x 1.5 / M22 x 2.0





TN

PNEUMATIC CHISEL TOOLS

OP 1480



Chisel set for an easier removal of corroded, seized or crimped parts.

Specifications:

- capacity: 2200bpm
- operating pressure: 5 to 8bar
- consumption: 114l/min
- noise level 100dB

Contents:

- SA1480: chipping/chisel hammer
- SA1481: adapter for 1/2" D. impact sockets
- SA1482: adapter for Ø38-63-74mm blocks
- SA1483: circular shaped block Ø38mm
- SA1484: rounded hollow block Ø63mm
- SA1485: circular shaped block Ø74mm
- SA1486: circular shaped block Ø25mm
- SA1487: rounded hollow block Ø25mm
- SA1488: 10pcs O-rings



INJECTOR EXTRACTOR RENAULT/NISSAN/OPEL 2.0-2.2-2.5 DCI

OM 9366

TN



Contents:

- SA9266: injector extractor Renault
- SA9269: Renault Master adapter
- SA9271: optional Renault support

Models:

Renault: Mégane 2-3, Scénic 2-3, Vel Satis, Laguna 2-3, Espace 3-4, Master 2-3, Trafic 2-3, Koleos
 Opel: Movano, Vivaro
 Nissan: Interstar, Primastar, Kubistar

Engines: 2.0-2.2-2.5 DCI

Codes: G9T, G9U, M9R

Injectors: Bosch, Bosch Piezo, Siemens, Siemens Piezo





TN

PNEUMATIC INJECTOR PULLER

OP 9110

Accessory of OH 0027/OH 0025/OM 9250/OM 9366

NEW

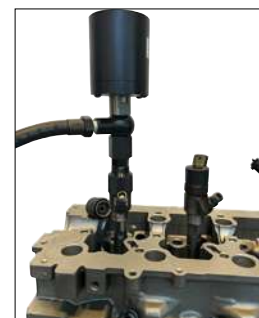

Specifications:

- max. cylinder height: 150mm
- min. cylinder height: 135mm
- overall hose length: 780mm
- regulated working pressure from 5 - 8 Bar (<100L/min)

Contents:

- 19 pieces (screws and adapter) M8/M10/M12/M14/M15/M17/M19
- 1 hose
- 1 pneumatic cylinder



VIBRATION PNEUMATIC PULLER FOR EXTRACTION INJECTORS

OP 9210

Accessory of OH 0027/OH 0025/OM 9250/OM 9366

Allows the take-off of seized injectors in all simplicity and autonomy. Optimum efficiency coupled with a hydraulic or manual extractor, to apply traction on the injector simultaneously with vibrations.



Specifications:

- average duration of use: 15min bursts
- max. pressure: 6.3bar
- no operator required after installation and start-up

Contents:

- pneumatic vibrator with regulator
- pair of inclined jaws
- pair of orthogonal jaws
- clamping screws jaws

Option:

- CO1025: injector/glow plug releaser 500ml
- OH0027: universal injector mechanical-hydraulic extraction kit



INJECTOR PULLER VOLVO/RENAULT/MAN/DAF

OM 9441



Engine codes:

- VOLVO D13-D16
- MAN TGA 460-480 , TGS
- MOTEUR D2676 EURO 5 , BE , CE , FR , GR
- DAF CF65 , CF65II , CF65IV , LF45 , LF45IV , LF55 , LF55IV





TN

INJECTOR EXTRACTOR KIT MERCEDES/CHRYSLER 2.1-2.2-3.0 V6 CDI

OM 5310

This kit allows the removal of Bosch and Delphi injectors mounted on 2.1, 2.2 and 3.0 V6 Mercedes and Chrysler engines. These tools allow the operator to access difficult to reach areas without dismantling the cylinder head.



Models:
Mercedes: Vito, Vario, CLK, Sprinter, Viano, Classe M, GL, C, GLK, E, CLS, S, R, G
Chrysler: 300 C

Engines:
Mercedes: 2.1, 2.2, 3.0 V6
Chrysler: 3.0 V6

- Contents:**
- SA9276: main body with extractor M18x1.5-M17x1 Bosch (2.1-2.2)
 - extractor screw M18x1.5-M14x1.5 Delphi (3.0V6)
 - 1/2" D. Injector socket double hex 29mm
 - OM9277: 1/2" D. Injector socket hex 10mm
 - extraction device (2.1-2.2)
 - extraction supports (3.0V6)



INJECTOR EXTRACTION KIT MERCEDES CDI

OM 0075



Models: Sprinter-Vito-Viano-Vario
Up to 2000
Engine codes: OM0611/OM0612/OM0613/OM0646/OM0647/OM0648



2 ADJUSTMENT JIGS FOR SCANIA PUMP INJECTORS

OM 9442



Allows height adjustment (66.9mm) when installing the BOSH injector type PDE 31/PDE 32 on 12 and 16L motors.

Engine codes:
OEM 99442 / 99414



REMOVAL ELECTRODE SOCKET INJECTORS HPI SCANIA PUMP (BOSCH)

OM 9432



INJECTOR SOCKET MAN Ø28mm DOUBLE HEX

OM 9433



This socket is machined to disassembly the power supply of injectors mounted on MAN TGA 460-480cv.

Engine: D26 euro 5 SCR





INJECTOR EXTRACTOR MAN

TN

OM 9443



For Common Rail TGL injectors on Euro 3-4-5/TGA/TGM/TGX engines.



INJECTOR LINER APPLICATION TOOL VOLVO/RENAULT 5-7L

TN

OM 9410



INJECTOR LINER APPLICATION TOOL VOLVO/RENAULT FH-FM

TN

OM 9411

Accessory of OM 9412



For 12-13 and 16L engines.



INJECTOR LINER APPLICATION TOOL VOLVO/RENAULT FH-FM

TN

OM 9412

Accessory of OM 9411



For 9-11-12-13 and 16L engines.



INJECTOR LINER APPLICATION TOOL PDE SCANIA

TN

OM 9420



INJECTOR LINER APPLICATION TOOL XPI SCANIA

TN

OM 9421



INJECTOR LINER APPLICATION TOOL HPI SCANIA

TN

OM 9422



INERTIAL INJECTOR GASKET EXTRACTOR

TN

OM 9275





WELL & INJECTOR SEAT CLEANING

COMPLETE INJECTOR SEAT CLEANING KIT

TN

OM 9110

This universal box of 35 pieces covers the entire intervention of cleaning and repair of injection wells. Once paired with one of the 13 cutters, the depth-adjustable cutter holder guarantees that it will not exceed the specified rework tolerance.



Contents:

- OM9280: 1 injector gasket extractor
- 1 reamer support
- SA9100: 1 brush drive line
- SA9110: 2 small diameter injector well brushes
- SA9111: 2 large diameter injector well brushes
- SA9112: 1 brush support
- 6 injector well plugs
- 13 reamers (9 flat, 4 conical)
 - 1 flat reamer L.14mm Ø14mm
 - 1 flat reamer L.15mm Ø19mm
 - 1 flat reamer L.15.5mm Ø15.5mm
 - 5 flat reamers L.17mm Ø17-17.5-19-19.5-20mm
 - 1 flat reamer L.19 Ø21.5mm
 - 1 conical reamer L.15.5mm Ø15.5mm
 - 2 conical reamers L.17mm Ø17-21mm
 - 1 conical reamer L.17.5mm Ø20.5mm
- 1 hexagonal wrench 2.5mm
- 1 T-handle and 170mm extension
- 1 cleaning tool L.250mm Ø15.5mm



INJECTOR SEAT CLEANING KIT

TN

OM 9100BL

This 21-piece B-LINE universal case allows the cleaning and repair of injector wells. Once paired with one of these 3 cutters, the depth-adjustable cutter holder guarantees not to exceed the specified rework tolerance.



Contents:

- OM 9280: 1 injector gasket extractor
- 1 reamer support
- SA9100: 1 brush drive line
- SA9110: 2 small diameter injector well brushes
- SA9111: 2 large diameter injector well brushes
- SA9112: 1 brush support
- 6 injector well plugs
- 2 flat reamers Ø17mm
- 1 conical reamer Ø17mm





BORE BRUSH SET

OM 0666



Métal-Nylon-Laiton Ø8 à Ø19mm

SA 0638	10 PCS Ø18mm BRASS BRUSHES SET
SA 0618	10 PCS Ø18mm NYLON BRUSH SET
SA 0619	10 PCS Ø19mm NYLON BRUSH SET
SA 0628	10 PCS Ø18mm METAL BRUSH SET
SA 0629	10 PCS Ø19mm METAL BRUSH SET
SA 0639	10 PCS Ø19mm BRASS BRUSHES SET



PETROL INJECTOR CLEANER 300ml

CO 1005

High-performance fuel treatment:

- dissolves polluting deposits (calamine, gum, varnish...) for clean combustion for optimal performance
- lubricates and protects cylinders
- cleans the injection system



The injection cleaner can be used both as a preventive measure (to protect the injection circuit) and as a curative measure.

- preventive use: 1 bottle for 80l
 - curative use: 1 bottle for 40l
- If you have never treated your vehicle before and if the first symptoms of injection malfunction are presenting themselves, the injection cleanser will allow you to deep clean the system.

Also available in box of 24

TN

DIESEL INJECTOR CLEANER 300ml

CO 1010

High-performance fuel treatment for direct injection diesel engines, common rail...

- dissolves polluting deposits (calamine, gum, varnish, combustion residues...) for clean combustion for optimal performance
- lubricates and protects mobile parts in diesel engines
- facilitates cold-starts
- cleans the injection system



The injection cleaner can be used both as a preventive (to protect the injection circuit) and as a curative measure.

- preventive use: 1 bottle for 80l
 - curative use: 1 bottle for 40l
- If you have never treated your vehicle before and if the first symptoms of injection malfunction are presenting themselves, the injection cleanser will allow you to deep clean the system.

Also available in box of 24

TN

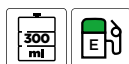



CYLINDER HEAD DIAGNOSTICS

CO2 DETECTION KIT

AC 3300

TN



- permet de vérifier la présence de gaz de combustion dans le radiateur.
- le liquide de test change de couleur si une fuite est détectée.
- identification rapide d'un joint de culasse défectueux.

1- positionner en lieu et place du bouchon de radiateur ou de vase d'expansion, le tube en plexiglas contenant une dose indiquée de liquide traceur (moteur chaud).

2- Placer la poire sur le tube et actionner celle-ci à plusieurs reprises. Les gaz contenus dans le circuit de refroidissement se mélangent au liquide traceur. Le liquide de test bleu change de couleur (vire au jaune) s'il y a une fuite de combustion interne et donc une présence de gaz CO2 dans le liquide de refroidissement.

Constat : problème au joint de culasse.

AC 3350 CO2 DETECTION FLUID

Spare part of AC 3300



TN

MECHANICAL STETHOSCOPE

OM 5026



Very simple diagnostic tool for listening to engines, cylinder heads, gearboxes, bearings... Made with steel and plastic, this tool is oil proof and complements researching sounds which are otherwise difficult to discern.

- extended steel probe: 290mm
- total length: 1100mm



BLACK SEALANT CARTRIDGE -40/+250 DEGREES 200ml

CO 1020

TN

+ Resistant to hydrocarbons



Allows joints to be sealed (sump, water pump, gearbox) and mechanical parts (fuel pumps, carburetors).

Also suitable for sealing headlights and electrical connections. Even adhesive in oil. Slow skin formation (20 minutes) to work serenely during major operations (gear box turning type).

Specifications:

- elastomer: 400% elasticity
- resistant to high temperatures (250°C)
- drying by touch: 20min
- vacuum package, with trigger

Also available in box of 12



300 ml ENGINE LEAK STOP

CO 1014

TN



Also available in box of 24





STRAIGHT EDGE FOR CHECKING CYLINDER HEAD FLATNESS 600mm

TN

AC 0010

Allows you to simply and precisely check for unevenness in surfaces such as the cylinder head or individual cylinder heads. Allows you to check up to 6 cylinder heads.



- tolerance: < 0.05mm
- material: Carbon steel SC50C
- dimensions: L.600xW.36xH.16mm



STRAIGHT EDGE FOR CHECKING CYLINDER HEAD FLATNESS 400mm

TN

AC 0011



Strong ribbing ensures high rigidity
Reinforced edges

Specifications:

- tolerance: < 0.05mm
- material: steel
- dimensions: L.400xW.40xH.8mm
- DIN 874



EXTERNAL MICROMETER 0-25mm

TN

AC 0517



Specifications:

- tempered steel touch
- metal contact surface
- matt chrome-plated body, antireflection
- locking by lever



MICROMETER 25-50mm

TN

AC 0528



CAST IRON SURFACE PLATE FOR CHECKING HEAD FLATNESS

TN

EG 1560



Specifications:

- strong ribbing for high rigidity
- reinforced edges
- tolerance: < 0.05mm
- weight: 80kg
- dimensions: L.800xL.500xH.90mm
- DIN 876

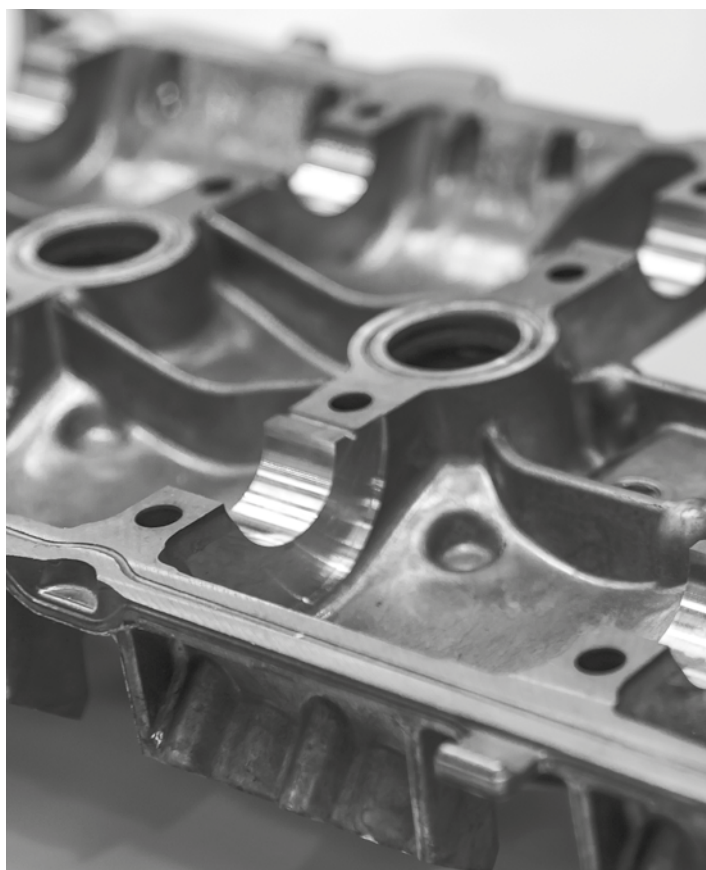



CALIPER TOOL

AC 0513

TN



Specifications:

- from 0 to 150mm
- resolution 1/20mm
- depth gauge
- locking knob



DIGITAL CALIPER

AC 0511

TN



Specifications:

- from 0 to 150mm
- resolution: 0.01mm
- reset in any position
- battery LR44 supplied



COMPARATOR+MAGNETIC BASE PACK

AC 0520

TN



Comparator specifications (AC0514):

- measurement range 0 to 30mm
- travel/turn: 1mm
- resolution 0.01mm
- chromed-steel case Ø57mm
- fixing rod Ø8mm
- point zero locking screw

Magnetic base specifications (AC0515):

- joint locking
- magnetic base, attraction strength 80kg
- height: 235mm
- vertical stalk Ø12mm
- weight: 1,850kg



FEELER GAUGE SET

AC 0518

TN



Specifications:

- 20 blades
- 0.05 to 1mm
- resolution: 0.05mm



50-160mm DRILLING INSPECTION DEVICE SET

AC 0530

TN



Allows to check the ovalization flaws of a drill hole from 50 to 160mm

Contents:

- 0.01mm resolution comparator
- cardan drill checker
- 12 pins L.50 to 105mm



MOUNTING GUIDE CYLINDER SET VOLVO/RENAULT 11-12-13-16L

OM 0112

TN



IMPACT SOCKET E28 3/4" L 90mm CYLINDER HEAD FOR MAN/SCANIA

OM 4528

TN



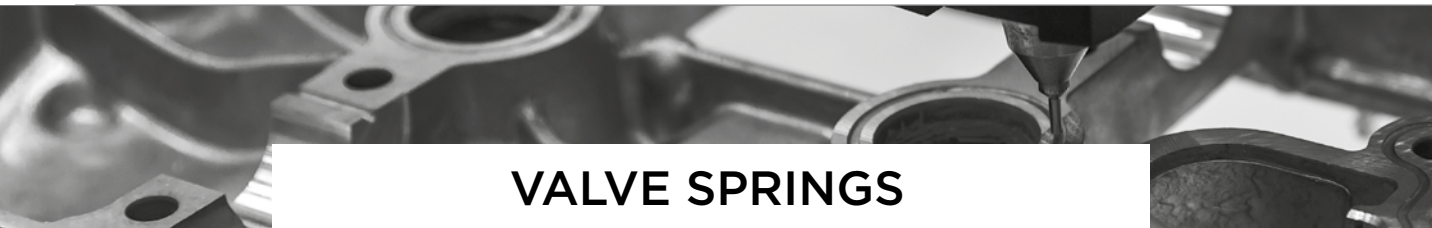

VALVE SPRINGS

SPRING LIFTER VALVE SET

OM 0104

+ Without disassembly of the cylinder head

Contents:

- 1 valve spring lifter
- 3 mounting brackets
- 4 compression cups Ø24, 28, 30, 36mm



PNEUMATIC VALVE GRINDING TOOL

OP 0102

This device grinds the valves automatically and perfectly evenly, by rotating alternately to the right and the left. All the rotating parts are precisely tooled, ensuring that the device has a long life. Sold in a plastic box complete with suction cups and sockets so that the valves can be picked up by the stem or the head. Shaft speed adjustment carried out by increasing or decreasing the air flow.



- Pneumatic grinding tool supplied with:
- SA6955: 1 rubber suction cup Ø22mm
 - SA6956: 1 rubber suction cup Ø33mm
 - SA6957: 1 rubber suction cup Ø40mm
 - 1 articulated tip door socket
 - supplied in a box



VALVE SPRING LIFTER

OM 0103

Can be used generally on a wide variety of engines (OHC, OHV et CVH)
Designed for petrol and diesel engines



- opening capacity 55-175mm, height under groove 165mm
- SA0103: reversible valve spring lifter adapter Ø25 & 30mm



UNIVERSAL VALVE LIFT HGV/ INDUSTRIAL VEHICLES

OM 0109



2 VALVE LAPPING TOOL SET

OM 0614

Suction cups: Ø15, Ø19, Ø27, Ø35mm



VALVE STEM SEAL DISMOUNTING PLIERS

OM 0106





PISTON & CYLINDER

PISTON RING
COMPRESSOR Ø65-
135mm H.100mm

OM 0154



PISTON RING
COMPRESSOR Ø90-
175mm H.165mm

OM 0155



PISTON INSERT
GUIDE DAF

OM 0159



Conical interior Ø139
to 129mm.



CYLINDER LINER APPLICATION
TOOL 60-160mm

OM 7450



Internal plug Ø60 to
160mm



EXPANDING ENGINE
CYLINDER HONE

OM 0503



Caractéristiques :

- réglable de Ø50 à Ø180mm
- SA5503 : 3 pierres de 100x11mm
- grain 240 médium

SA 5503 3 STONE SET



UNIVERSAL CYLINDER LEAK DETECTOR TESTER

AC 0118



This tool allows the seal of the cylinders to be tested without the need to open up the engine. It is one of the simplest and fastest tests to use to check the engine's condition. Air is injected through the plug well into each cylinder, and the dial indicates if there's any pressure loss. Engine compression leaks can damage valves, wear segments, crack the cylinder head gasket or the cylinder head.

The adapters supplied with this leak tester fit with all the plug wells (10, 12, 14, 18mm) and the long adapter (220mm) is very useful for the plugs with deep wells.





PISTON & CYLINDER

← FIND THE COMPLETE RANGE OF **PISTON & CYLINDER** HERE

TN



COMPRESSION MEASURING KIT FOR DIESEL ENGINES

AC 0224

Easy and ready to use, this kit covers 90% of vehicles. Applications available on request.

Contents:

- AC0200 : 1 x diesel compression gauge
- AC2024 : 1 x diesel glow plug kit



TN



MULTI-BRAND COMPRESSION GAUGE PETROL-DIESEL/DCI

AC 2018BL

Complete set for petrol and diesel engines with direct and indirect injection.

Specifications:

- quick connector adapter
- 1.400mm hose for difficult access points
- 0 to 40bar manometer with release valve

PSA, VAG, Alfa, BMW, Chrysler, Daewoo, Daihatsu, Fiat, Ford, Honda, Hyundai, Isuzu, Jeep, Kia, Lada, Lancia, Land Rover, LDV, Mazda, Mercedes, MG, Mitsubishi, Nissan, Opel, Renault, Rover, Saab, Ssangyong, Suzuki, Toyota, Volvo.

B.LINE
BUDGET SOLUTION



TN



DIESEL GLOW PLUG KIT

AC 2024

Accessory of AC 0200/AC 0118/AC 2016/AC 0800/SA 2210

Glow-plug kit (diesel and common rail) that can connect to AC0200 compression gauges and AC0118 seal sensors.

Covers 90% of vehicle - applications available on request.



UNIVERSAL DUMMY INJECTOR

AC 2021

Accessory of AC 0200/AC 2024/AC 0224/AC 0800

Universal dummy injector, can be mounted in place of the original injector for engine compression.



Universal,
5 in 1



Contents:

- dummy injector body
- 5 adapters/nose injectors
- 7 injector length adjustment spacers
- 3 fixing flanges
- spare copper gasket pouch

Adapters/Nose:

- Ø16.75mm without nose
- Ø16.75mm nose Ø6.65mm
- Ø20.55mm nose Ø13.65mm
- Ø23.70mm nose Ø13.65mm
- Ø23.75mm nose Ø5.75mm



TN



FUEL PLIERS

FAST FUEL CONNECTORS CLAMP

OM 9398

Specially designed for quickly unplugging connectors and fast connections with 2 buttons laterally accessible (fuel lines, ADblue, depressions, etc.)



Specifications:

- opening: 3 to 32mm
- torque locking system



PETROL AND DIESEL FUEL CONNECTION PLIER

OM 0504





FUEL FILTER WRENCHES

GAZOLE FILTER WRENCH
Ø95mm 14-SIDED

TN

OM 0316



Applications:
Man F2000, TGA, TGV



3/8" AdBlue® D. FILTER WRENCH
Ø46mm MERCEDES BLUE-TEC

TN

OM 9210



DIESEL FUEL FILTER REMOVAL KIT
OPEL/FIAT/PSA/SUZUKI/SAAB/LANCIA

TN

HU 2027

This removal diesel fuel filter parts was created for removal and replacement of filter element without any risks of harming the filter's plastic body. This housing is not disposable and supplied filter is only a replacement element.

This kit is composed with 2 pieces:

- A vice holder for external body of filter to hold it securely
- An adaptor which is positioned on the top of the housing to allow release with a 1/2" square

Applications:
Chevrolet, Citroën, Fiat, Saab, Suzuki, Vauxhall, Opel, Lancia

Engines:
1.3 JTD-CDTI-DDIS-MJTD
1.9 JTD-CDTI-TID
2.0 VCDI-HDI-JTD
2.2 JTD-HDI
2.3 JTD
2.8 JTD-HDI
3.0 JTD-HDI



FUEL FILTER WRENCH PSA/RENAULT 3/8"

TN

OM 9267



Ø108mm



FUEL FILTER WRENCH 3/8" FORD TRANSIT/MONDEO 2.2I TDCI

TN

OM 9336

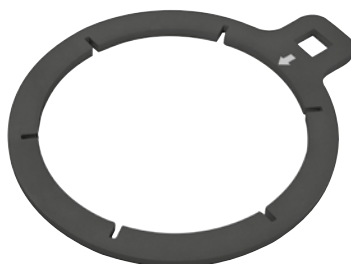

Specially designed to install and remove fuel filters on Ford Mondeo and Transit 2.2I TDCi >2012. Does not damage the filter receiver, ensures correct and leak-free reassembly.

Drive: 3/8"





FUEL FILLING

STRAP WRENCH DEHYDRATING CARTRIDGE

TN

HU 0010BL

B.LINE
BUDGET SOLUTION



Length of the strap: 500mm



HGV STRAP WRENCH 1/2"

TN

HU 0008

+ Do not damage filters



Specifications:

- max capacity: Ø150mm
- strap L.700mm, largeur 50mm
- drive 1/2"



METAL STRAP WRENCH FOR DESICCANT CARTRIDGE

TN

HU 0014



- Ø min: 125mm
- Ø max: 140mm
- drive: 1/2"



FUEL FILTER WRENCH Ø109mm PSA/RENAULT 3/8"

TN

OM 9339

Specially designed for mounting/removing plastic covers when replacing fuel filters.

Specifications:

- Ø109mm
- 8 pins
- 3/8" drive
- can be tightened with a torque wrench
- doesn't damage the cartridge or its holder
- ensures watertightness

Affectations: PSA, Renault



DIESEL STARTING BLEEDING PNEUMATIC KIT

TN

AC 4097



Contents:

- OPO053BL : 1 x pneumatic vacuum brake bleeder
- AC4096 : 1 x diesel starting bleeding kit





ADBLUE®

FIND THE COMPLETE RANGE OF ADBLUE® HERE



ADBLUE®

REFRACTOMETER

TN

AC 4066

For checking:

- cooling liquid 0 to -50°C
- battery liquid density: 1.1 to 1.4kg/l
- windshield washer liquid 0 to -40°C
- adBlue

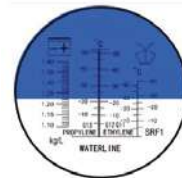

3/8" AdBlue® D. FILTER WRENCH Ø46mm MERCEDES BLUE-TEC

TN

OM 9210



AdBlue® DISTRIBUTION DEVICE

TN

HU 0640

Spare part of HU 0670



- Suitable for all kinds of transfer installations, even those which operate with gravity
- Simple and economical
- Excellent functioning thanks to low flow resistance

Equipped with lever protection with trigger blocking system (can be removed).



ROTARY PUMP SUITABLE FOR AdBlue®

TN

HU 0013

Special pump to transfer AdBlue. Also suitable for other fluids like water, diesel, oil...



Specifications:

- supplied with a 2" bsp fitting
- 0.3 litre per crank turn
- inlet tube 1000mm
- fixing Ø59mm thread 200



HYBRID & ELECTRIC



PROTECTION

P.332



SIGNS

P.335

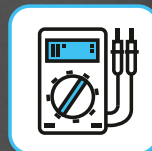

ELECTRONICS

P.338



INSULATED TOOLS

P.341



LIFTING

P.347



REELS & LOAD

P.350

WORK ON HYBRID & ELECTRIC VEHICLES.

The automotive sector is in the throes of change. By 2030, there will be almost **150 million electric/hybrid vehicles on the road worldwide!**

CLAS is mobilizing its research and development teams to offer you today's mobility solutions, with products designed for the automotive industry.

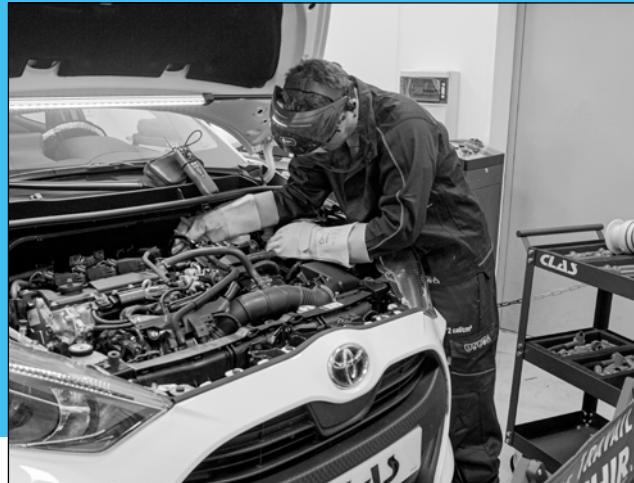

WHAT ARE THE DANGERS?



ELECTRICAL RISKS



TOXIC RISKS



PROJECTION RISKS



THERMAL RISKS

ELECTRIC ARC RISKS

- 3rd degree burns
- Hearing damage/loss
- Respiratory tract damage
- Eye damage

Electrical accidents can also cause significant collateral damage, such as accidental start-up of equipment or machinery, falls from height, fire...

In France, work on traction components requires authorization (BOL, B2VL, BEL, etc.).

How to work on hybrid/electric vehicles

- be trained and authorized
- be equipped
- comply with current standards (NF C18-550)

Think about it:

Before working on hybrid and electric vehicles, technicians must undergo training to enable them to carry out work. According to Art. R. 4544-10 of the French Labor Code, it is the employer's responsibility to issue, maintain or renew authorization in accordance with the procedures set out in the standards referred to in Article R. 4544-3, depending on the operations to be entrusted to the worker.

Consult us for training organization.

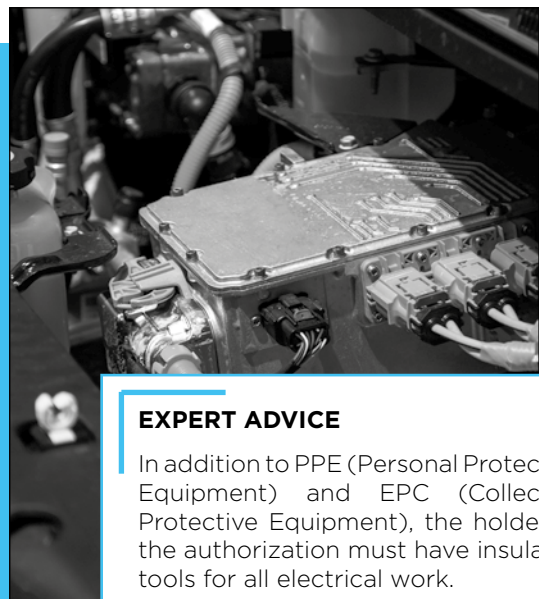

EXPERT ADVICE

In addition to PPE (Personal Protective Equipment) and EPC (Collective Protective Equipment), the holder of the authorization must have insulated tools for all electrical work.



PARTNER OF



CESVI FRANCE



CESVI France is the only training and technical research center of its kind in France for the automotive insurance industry. The company, which provides training in electrical authorizations (in particular), has joined forces with CLAS to offer solutions tailored to each profession and each operation.

In France, the Labor Code stipulates that all "operations on electrical installations or in their vicinity may only be carried out by authorized workers." (art. R4544-9)

Authorization is symbolized conventionally by alphanumeric characters and, if necessary, by an attribute :

- the 1st character represents the domain :
letter B (low voltage up to 1500V)
- the second character represents the type of operation (index or letter)
 - 0:** Carries out or directs non-electrical operations
 - 1:** Carries out electrical operations
 - 2:** Ensures the direction and application of electrical work
 - C:** Carries out consignment
 - E:** Carries out test or expertise operations
- the third character represents the nature of the operations:
 - T:** Working under voltage
 - V:** Working in close proximity
 - X:** Special intervention
- the fourth character represents the field of application:
letter L characterizes operations on vehicles/engines with on-board electrical power.

B1TL

Certifications	BOL/BEL	BCL/B1VL/B2VL	B1XL/B2XL	B1TL/B2TL
	Non-electrical intervention	Electrical lockout/tagout	Special intervention	Energized electrical work
VO/VN preparer	OE 0371 p. 328			
Fast service mechanic	OE 0371 p. 328			
Technician/ Diagnostics		OE 0373 p. 330		OE 0374 p. 331
Painter		OE 0373 p. 330		
Coachbuilder		OE 0373 p. 330		
Emergency			OE 0372 p. 329	
Breakdown service/ Towing			OE 0372 p. 329	
Technical inspection			OE 0372 p. 329	
Vehicle immobilizer/ recycler	OE 0371 p. 328	OE 0373 p. 330	OE 0372 p. 329	OE 0374 p. 331





OUR HABILITATION PACKS

TN

BEL/BOL

NEW

BEL/BOL ELECTRICAL CERTIFICATION PACK (6PCS)

OE 0371

C.P.E.

ELECTRICAL SAFETY STAND
EG 0033



SAFETY STEERING WHEEL COVER
EG 0031



ELECTRICAL DANGER SIGN SUCTION PAD 200mm
EG 0035



P.P.E.



FACIAL PROTECTION SCREEN FOR ELECTRICAL ARCS

OE 0311



PAIR OF INSULATED GLOVES CLASS 0 T10

OE 0310





B1XL/B2XL

NEW

**74
PIECES**

B1XL/B2XL ELECTRICAL CERTIFICATION PACK (74PCS)

OE 0372

This kit is dedicated to professionals working on specific projects, such as breakdown and towing companies, scrap merchants, roadworthiness inspectors and fire departments.

P.P.E.



OE 0310	PAIR OF INSULATED GLOVES CLASS 0 T10
OE 0311	FACIAL PROTECTION SCREEN FOR ELECTRICAL ARCS
OE 0306	PNEUMATIC TESTER FOR INSULATING GLOVES
OE 0567	COVER FOR GLOVES & UNDERGLOVES
OE 0566	CANVAS COVER FOR HELMET OR FACE SHIELD
OE 0303	LEATHER OVERGLOVES FOR INSULATED GLOVES
OE 0720	INSULATED RESCUE ROD L.147cm

STORAGE



341 WATERPROOF TOOL CASE
EG 0068

C.P.E.



ELECTRICAL SAFETY STAND
EG 0033



ELECTRICAL DANGER SIGN SUCTION PAD 200mm
EG 0035



SAFETY STEERING WHEEL COVER
EG 0031



ADHESIVE SIGNALING AND SAFETY VINYL TAPE 33m W.50mm
EG 1050

HAND TOOLS

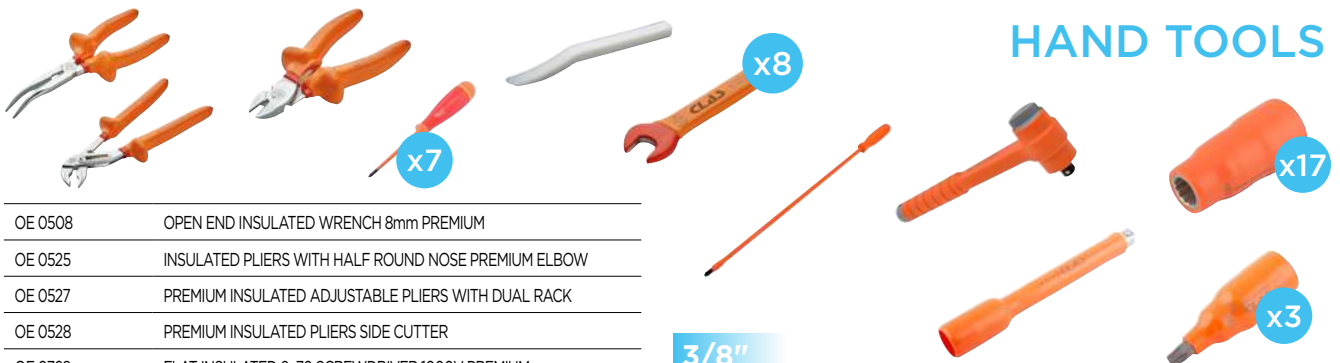

OE 0508	OPEN END INSULATED WRENCH 8mm PREMIUM
OE 0525	INSULATED PLIERS WITH HALF ROUND NOSE PREMIUM ELBOW
OE 0527	PREMIUM INSULATED ADJUSTABLE PLIERS WITH DUAL RACK
OE 0528	PREMIUM INSULATED PLIERS SIDE CUTTER
OE 0768	FLAT INSULATED 2x70 SCREWDRIVER 1000V PREMIUM
OE 0778	PHILLIPS INSULATED NO 4x75 SCREWDRIVER 1000V PREMIUM
OE 0561	TORX INSULATED T30 SCREWDRIVER 1000V PREMIUM
OE 0759	INSULATED HANDLE WITH FLEXIBLE ROD AND MAGNETIC TIP
OE 0760	ISOLATING LEVER 1000V

3/8"

OE 0738	INSULATED EXTENSION 3/8" 140mm PREMIUM
OE 0761	INSULATED RATCHET 1000V 3/8" PREMIUM
OE 02310247	3/8" DOUBLE HEX INSULATED SOCKET 8mm24mm
OE 0790	INSULATED SOCKET 3/8" TORX MALE T15

GENERAL TOOLS

OE 0755	INSULATING SHEET 3/10th 12.5x1.3m
OE 0756	4 SPRING CLIP FOR INSULATING SHEET
OE 0784	4 INSULATION CAPS Ø25mm L.120mm
OE 0795	4 INSULATION CAPS Ø10mm L.60mm
OE 0796	4 INSULATION CAPS Ø15mm L.100mm
OE 0798	4 INSULATED CAPS Ø60mm L.140mm
OE 3010	VOLTAGE SAFETY TESTER
OE 3011	BLACK TOUCH POINT IP2X FOR VAT DEVICE
OE 3012	RED TOUCH POINT IP2X FOR VAT DEVICE





BCL/B1VL/B2VL

NEW**117
PIECES**

BCL/B1VL/B2VL ELECTRICAL CERTIFICATION PACK (117PCS)

OE 0373

This kit is dedicated to professionals working on live electrical work, such as consignment officers, diagnostic technicians, body repairers, painters, paint strippers, etc.



P.P.E

OE 0303	LEATHER OVERGLOVES FOR INSULATED GLOVES
OE 0306	PNEUMATIC TESTER FOR INSULATING GLOVES
OE 0310	PAIR OF INSULATED GLOVES CLASS 0 T10
OE 0311	FACIAL PROTECTION SCREEN FOR ELECTRICAL ARCS
OE 0566	CANVAS COVER FOR HELMET OR FACE SHIELD
OE 0567	COVER FOR GLOVES & UNDERGLOVES
OE 0720	INSULATED RESCUE ROD L.147cm

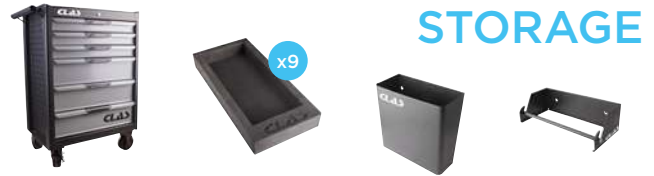

STORAGE

EG 0080	FOAM STORAGE TRAY
EG 0088	6 DRAWERS ROLLER CABINET
EG 8001	METAL WORKSHOP WASTE FOR DRAWER
EG 8009	DISPENSER/HAND TOWEL ROLL STAND FOR DRAWERS



GENERAL TOOLS

OE 0755	INSULATING SHEET 3/10th 12.5x1.3m 4-6mm
OE 0756	SPRING CLIP FOR INSULATING SHEET
OE 0764	SELF-GRIPPING INSULATING SHEET 660mmx360mm
OE 0795	4 INSULATION CAPS Ø10mm L.60mm
OE 0796	4 INSULATION CAPS Ø15mm L.100mm 24mm
OE 0797-84-85	4 INSULATION CAPS Ø20mm L.120mm
OE 0798	4 INSULATED CAPS Ø60mm L.140mm
OE 3010	VOLTAGE SAFETY TESTER
OE 3011	BLACK TOUCH POINT IP2X FOR VAT DEVICE
OE 3012	RED TOUCH POINT IP2X FOR VAT DEVICE



C.P.E.

OE 0562	DEPOSIT BAG
OE 0563	LOCKING DISC
OE 0564	LOCKING PADLOCK
OE 0758	INSULATING SLEEVE FOR CONNECTOR 305mmx225mm
EG 0013	PLASTIC SIGNALING CHAIN YELLOW/BLACK 25m
EG 0014N	YELLOW AND BLACK SIGNPOST Ø40mm
EG 0015	SIGNAGE BANNER "WORK ZONE BOUNDARY" 100x20cm
EG 0031	SAFETY STEERING WHEEL COVER
EG 0035	ELECTRICAL DANGER SIGN SUCTION PAD 200mm
EG 1050	ADHESIVE SIGNALING AND SAFETY VINYL TAPE 33m W.50mm



1/4"

OE 0265	1/4" INSULATED FEMALE HEX SOCKET 4mm
OE 0281	1/4" HEX INSULATED MALE SOCKET 4mm 4-6mm
OE 0786	INSULATED RATCHET 1000V 1/4" PREMIUM
OE 0788	1/4" INSULATED LONG EXTENSION 1000V PREMIUM 24mm



3/8"

OE 0738	INSULATED EXTENSION 3/8" 140mm PREMIUM
OE 0761	INSULATED RATCHET 1000V 3/8" PREMIUM
OE 0231 to OE 0247	3/8" DOUBLE HEX INSULATED SOCKET 8mm to 24mm
OE 0790 to OE 0794	INSULATED SOCKET 3/8" TORX MALE T15, T20, T25, T30, T40



HAND TOOLS

OE 0508-10-12-13-14-15-17-18-19-22	OPEN END INSULATED WRENCH 8mm PREMIUM8, 10, 12, 13, 14, 15, 17, 18, 19, 22 mm
OE 0527	PREMIUM INSULATED ADJUSTABLE PLIERS WITH DUAL RACK
OE 0528	PREMIUM INSULATED PLIERS SIDE CUTTER
OE 0768	FLAT INSULATED 2x70 SCREWDRIVER 1000V PREMIUM
OE 0778	PHILLIPS INSULATED NO 4x75 SCREWDRIVER 1000V PREMIUM
OE 0561	TORX INSULATED T30 SCREWDRIVER 1000V PREMIUM
OE 0759	INSULATED HANDLE WITH FLEXIBLE ROD AND MAGNETIC TIP
OE 0760	ISOLATING LEVER 1000V



B1TL/B2TL

NEW

**148
PIECES**

B1TL/B2TL ELECTRICAL CERTIFICATION PACK (148PCS)

OE 0374

This kit is dedicated to professionals working on live electrical work, such as consignment officers, diagnostic technicians, body repairers, painters, paint strippers, etc.



P.P.E

OE 0303	LEATHER OVERGLOVES FOR INSULATED GLOVES
OE 0306	PNEUMATIC TESTER FOR INSULATING GLOVES
OE 0310	PAIR OF INSULATED GLOVES CLASS 0 T10
OE 0311	FACIAL PROTECTION SCREEN FOR ELECTRICAL ARCS
OE 0566	CANVAS COVER FOR HELMET OR FACE SHIELD
OE 0567	COVER FOR GLOVES & UNDERGLOVES
OE 0720	INSULATED RESCUE ROD L.147cm



STORAGE

EG 0080	FOAM STORAGE TRAY
EG 0088	6 DRAWERS ROLLER CABINET
EG 8001	METAL WORKSHOP WASTE FOR DRAWER
EG 8009	DISPENSER/HAND TOWEL ROLL STAND FOR DRAWERS



GENERAL TOOLS

OE 0755	INSULATING SHEET 3/10th 12.5x1.3m 4-6mm
OE 0756	SPRING CLIP FOR INSULATING SHEET
OE 0764	SELF-GRIPPING INSULATING SHEET 660mmx360mm
OE 0795	4 INSULATION CAPS Ø10mm L.60mm Ø10, 15, 20, 25, 35, 60mm
OE 3010	VOLTAGE SAFETY TESTER
OE 3011	BLACK TOUCH POINT IP2X FOR VAT DEVICE
OE 3012	RED TOUCH POINT IP2X FOR VAT DEVICE
OE 0799	4 INSULATED SHEET MAGNETS
OE 4002	MEGOHMMETER 1000V CAT. III & 600V CAT. IV



C.P.E

OE 0562	DEPOSIT BAG
OE 0563	LOCKING DISC
OE 0564	LOCKING PADLOCK
OE 0758	INSULATING SLEEVE FOR CONNECTOR 305mmx225mm
EG 0013	PLASTIC SIGNALING CHAIN YELLOW/BLACK 25m
EG 0014N	YELLOW AND BLACK SIGNPOST Ø40mm
EG 0015	SIGNAGE BANNER "WORK ZONE BOUNDARY" 100x20cm
EG 0031	SAFETY STEERING WHEEL COVER
EG 0035	ELECTRICAL DANGER SIGN SUCTION PAD 200mm
EG 1050	ADHESIVE SIGNALING AND SAFETY VINYL TAPE 33m W.50mm



1/4"

OE 0265	1/4" INSULATED FEMALE HEX SOCKET 4mm
OE 0281	1/4" HEX INSULATED MALE SOCKET 4mm 3-7mm
OE 0786	INSULATED RATCHET 1000V 1/4" PREMIUM
OE 0788	1/4" INSULATED LONG EXTENSION 1000V PREMIUM 24mm



3/8"

OE 02310247	3/8" DOUBLE HEX INSULATED SOCKET 8mm24mm
OE 0790	INSULATED SOCKET 3/8" TORX MALE T15
OE 0766	INSULATED TORQUE WRECK 3/8" 10-50Nm
OE 0738	INSULATED EXTENSION 3/8" 140mm PREMIUM
OE 0761	INSULATED RATCHET 1000V 3/8" PREMIUM



HAND TOOLS

OE 0508	OPEN END INSULATED WRENCH 8mm PREMIUM
OE 0525	INSULATED PLIERS WITH HALF ROUND NOSE PREMIUM ELBOW
OE 0527	PREMIUM INSULATED ADJUSTABLE PLIERS WITH DUAL RACK
OE 0528	PREMIUM INSULATED PLIERS SIDE CUTTER
OE 0768	FLAT INSULATED 2x70 SCREWDRIVER 1000V PREMIUM
OE 0778	PHILLIPS INSULATED N0 4x75 SCREWDRIVER 1000V PREMIUM
OE 0561	TORX INSULATED T30 SCREWDRIVER 1000V PREMIUM
OE 0759	INSULATED HANDLE WITH FLEXIBLE ROD AND MAGNETIC TIP
OE 0760	ISOLATING LEVER 1000V

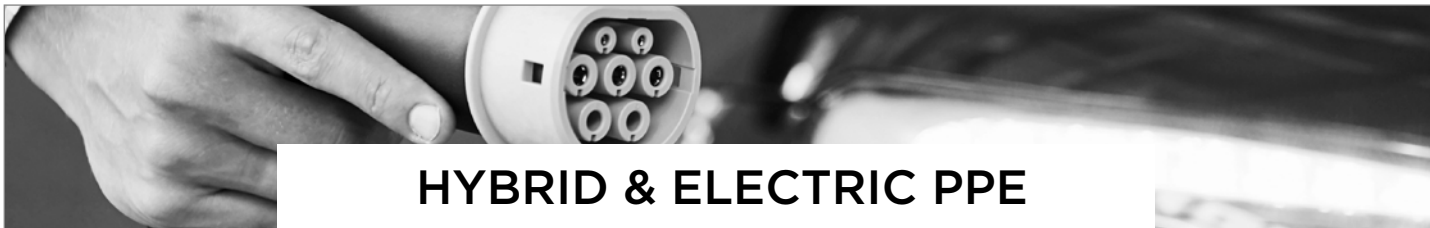

HYBRID & ELECTRIC PPE

ELECTRIC ARC PROTECTIVE JACKET

TN

Specifications:

- flash arc class 1, ATPV 12 cal/cm²
- standards: EN 13034: 2005 / EN 1149-5: 2008 / EN ISO 11611: 2007 / EN ISO 11612: 2008 / IEC 61482-2: 2009 (CLASS 1 AND ATPV 12 cal/cm²)
- fabric composition: 79% cotton, 20% polyester, 1% antistatic fiber, 300 gr/m²
- ATEX zone



OE 0530	S
OE 0531	M
OE 0532	L
OE 0533	XL
OE 0534	2XL



ARC PROTECTION PANTS

TN

Specifications:

- flash arc class 1, ATPV 12 cal/cm²
- standards: EN 13034: 2005 / EN 1149-5: 2008 / EN ISO 11611: 2007 / EN ISO 11612: 2008 / IEC 61482-2: 2009 (CLASS 1 AND ATPV 12 CAL/CM²)
- fabric composition: 79% cotton, 20% polyester, 1% antistatic fiber, 300 gr/m²
- ATEX zone



OE 0547	S
OE 0548	M
OE 0549	L
OE 0550	XL
OE 0551	2XL



INSULATING SAFETY BOOTS

TN

STANDARDS:
EN ISO 20345:2012
EN 12568
ISO 5423:92



OE 0538	38
OE 0539	39
OE 0540	40
OE 0541	41
OE 0542	42
OE 0543	43
OE 0544	44
OE 0545	45
OE 0546	46



FACIAL PROTECTION SCREEN FOR ELECTRICAL ARCS

TN

OE 0311

Class 1B8
Colorless
2C-1.2 U 1 AT 8 9 0068 CE



Specifications:

- conforms to standard EN 166, EN 170
- liftable anti-scratch screen with ventilated forehead protection
- double-setting ear muffs
- ultraviolet filter
- screen thickness: 1.5mm
- weight: 380g



PAIR OF INSULATED GLOVES CLASS 0 T9

OE 0309

3 IN 1



EN 60903 classe 0
ELECTRICAL HAZARDS



IEC 61482-1-2
ELECTRIC ARC HAZARDS



EN 388
MECHANICAL RISKS



+ Comfort, dexterity, triple protection





PAIR OF 1000V INSULATING GLOVES

OE 0302

Size 10

Compatible with authorizations: B1L, B1VL, B1TL, B2L, B2VL, B2TL, BCL, BEL, BRL, B1XL, B2XL
Standard : EN 60903



TN

PNEUMATIC TESTER FOR INSULATING GLOVES

OE 0306

NEW



TN

LEATHER OVERGLOVES FOR INSULATED GLOVES

OE 0303

Size 10

Standards: EN-388

Compatible with authorizations: B1L, B1VL, B1TL, B2L, B2VL, B2TL, BCL, BEL, BRL, B1XL, B2XL.



NO WARRANTY

+ Small footprint, ergonomic

NO WARRANTY

PERSONAL ELECTRICAL PROTECTION EQUIPMENT SET

OE 0332

Contents:

- OE0310: class 0 size 10 insulating gloves
- OE0311: facial protection screen for electrical arcs

Specifications:

- compatible with authorizations: B1L, B1VL, B1TL, B2L, B2VL, B2TL, BCL, BEL, BRL, B1XL, B2XL.



OE 0310

OE 0311



TN

MUST-HAVE

ELECTRICAL INDIVIDUAL PROTECTION EQUIPMENT MASTER SET

OE 0342

Contents:

- OE0310 : pair of insulating gloves size 10 class 0 (3 in 1: 1000 v electrical protection, mechanical protection (no need for over gloves) and thermal protection (ARC FLASH))
- OE0567: cover for gloves & undergloves
- OE0311: facial protection screen for electrical arcs
- OE0566: canvas cover for helmet or face shield
- OE0306: pneumatic inspection device to test insulating gloves



OE 0566



OE 0567



OE 0306



OE 0310



OE 0311

TN



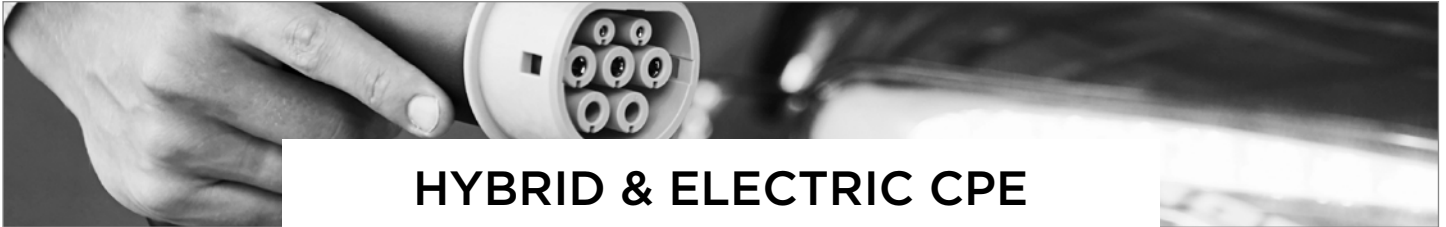

HYBRID & ELECTRIC CPE

MARKING/WORK AREA SIGNALING PACK

EG 0012



EG 0015



EG 0014-1

EG 0014-2



EG 0013

TN

Contents:

- EG0013: yellow/black 25m plastic signaling chain
- EG0014-1 (x6): yellow and black signpost Ø40mm
- EG0014-2 (x6): base for signpost
- EG0015: signage banner "work zone boundary" 100x20cm



Compatible with authorizations: B1L, B1VL, B1TL, B2L, B2VL, B2TL, BCL, BEL, BRL, B1XL, B2XL.



COLLECTIVE PROTECTION EQUIPMENT MASTER SET

EG 0001



EG 0015



EG 0031

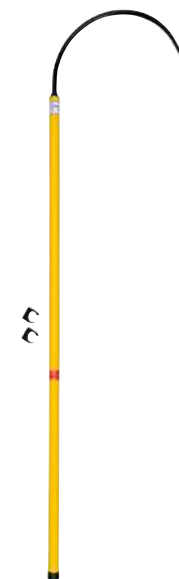

OE 0720



EG 0013

TN



EG 0014-1

EG 0014-2

Contents:

- EG0013: plastic signaling chain yellow/black 25m
- EG0015: signage banner "work zone boundary" 100x20cm
- EG0031: safety steering wheel cover
- OE0720: insulating rescue rod 1.147cm
- EG0014-1 (x6) : yellow and black signpost Ø40mm
- EG0014-2 (x6) : yellow and black base for signpost Ø40mm



HYBRID & ELECTRIC SIGNS

SIGNAGE BANNER "WORK ZONE BOUNDARY" 100x20cm

EG 0015

Specifications:

- 4 eyelets + 2 fixing cords
- coated fabric
- dimensions: 100x20cm

Compatible with authorizations: B1L, B1VL, B1TL, B2L, B2VL, B2TL, BCL, BEL, BRL, B1XL, B2XL.



TN



YELLOW AND BLACK SIGNPOST Ø40mm

EG 0014N

Specifications:

- 2 rings with chain/strap connection
- post material: black and yellow solution-dyed plastic
- base material: solid rubber
- height: 90cm

Compatible with authorizations: B1L, B1VL, B1TL, B2L, B2VL, B2TL, BCL, BEL, BRL, B1XL, B2XL.



TN



PLASTIC SIGNALING CHAIN YELLOW/BLACK 25m

EG 0013

Accessory of EG 0014

Allows a work zone or a dangerous area to be delimited...

Ø links: 6mm

+ Interior and exterior use



TN



ELECTRICAL SAFETY STAND

EG 0033

Used to alert an area of potential electrical danger.



TN



SIGNPOSTING REEL 20m

EG 0017



TN



ADHESIVE SIGNALING AND SAFETY VINYL TAPE 33m W.50mm

EG 1050



TN



ELECTRICAL DANGER SIGN SUCTION PAD 200mm

EG 0035

NEW



Compatible with authorizations: B1L, B1VL, B1TL, B2L, B2VL, B2TL, BCL, BEL, BRL, B1XL, B2XL.

TN





INSULATING SHEET 3/10th 12.5x1.3m

OE 0755

Allows temporary insulation in order to install parts and conductors which are exposed or insufficiently insulated.



Specifications:

- max. voltage: 1000V AC
- material: Insulating, fireproof PVC
- thickness: 3/10th
- dimensions: 12.5x1.3m

Compatible with authorizations: B1L, B1VL, B1TL, B2L, B2VL, B2TL, BCL, BEL, BRL, B1XL, B2XL.
 Conforms to standards ST TST BT 420 and IEC 61112 category 0 (1000V).



TN

SPRING CLIP FOR INSULATING SHEET

OE 0756

Accessory of OE 0755



Compatible with authorizations: B1L, B1VL, B1TL, B2L, B2VL, B2TL, BCL, BEL, BRL, B1XL, B2XL.

Specifications:

- capacity: 25mm
- dimensions: 165x18mm



TN

4 INSULATED SHEET MAGNETS

OE 0799



Diameter: 70mm
 Thickness: 5mm
 Weight: 35g



TN



INSULATING SLEEVE FOR CONNECTOR 210mmx130mm

OE 0757

Specifications:

- temporary protection
- electrical standard: CEI 60900
- dimension: 130x210mm
- transparent

INSULATING SLEEVE FOR CONNECTOR 305mmx225mm

OE 0758

Specifications:

- temporary protection
- electrical standard: CEI 60900
- dimension: 225x305mm
- transparent



TN

SELF-GRIPPING INSULATING SHEET 660mmx360mm

OE 0764



Specifications:

- temporary protection
- standard: CEI 60900

+ Electrical insulation ,
 Velcro , secure



TN



TN



OE 0795	4 INSULATION CAPS Ø10mm L.60mm
OE 0798	4 INSULATED CAPS Ø60mm L.140mm
OE 0785	4 INSULATION CAPS Ø35mm L.120mm
OE 0784	4 INSULATION CAPS Ø25mm L.120mm
OE 0797	4 INSULATION CAPS Ø20mm L.120mm
OE 0796	4 INSULATION CAPS Ø15mm L.100mm

NEW



NO WARRANTY

CLASS 0 INSULATING MAT - 100x60cm

OE 0750



Conforms to standard IEC 61111:2009

Specifications:

- max. voltage: 1000V AC
- thickness: 1,5mm
- dimensions: 100x60cm

NO WARRANTY

TN

INSULATED RESCUE ROD L.147cm

OE 0720

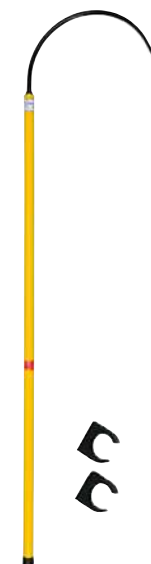

For the rescue of agents affected by electrification and/or dazzle when repairing a voltage tester for example. Allows the injured party to be brought to safety by pulling them by the waist.

Specifications:

- operating voltage: 45,000V
- steel hook 18x1,5mm
- tensile force: 150kg

Compatible with authorizations: B1L, B1VL, B1TL, B2L, B2VL, B2TL, BCL, BEL, BRL, B1XL, B2XL.

Supplied with wall hooks.

NO WARRANTY

TN

SAFETY STEERING WHEEL COVER

EG 0031



Specifications:

- diameter: 400mm

NO WARRANTY

TN

DEPOSIT BAG

OE 0562

Allows to lock the plugs and connectors. To be done by the authorized technician. Lockable with a padlock.

Specifications:

- nylon bag
- dimensions L.482x1.165mm

Must be used with the locking padlock (OE0564).



2 WARRANTY

TN

LOCKING DISC

OE 0563

Hole of 10mm of diameter on the upper part allowing to receive a padlock.



Specifications:

- Plastic disc
- Diameter: 80mm

Must be used with the locking padlock (OE0564).

NO WARRANTY

TN

LOCKING PADLOCK

OE 0564

Specifications:

- color: Orange
- handle material: Composite
- inside height of handle: 38mm
- handle diameter: 4.5mm



2 WARRANTY

TN

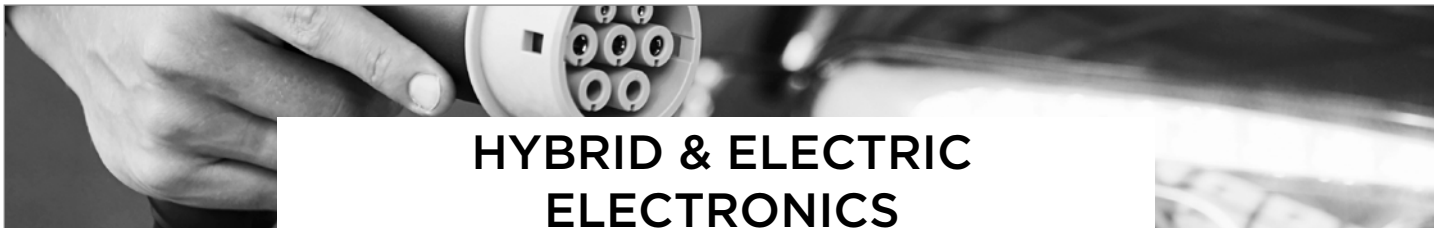

HYBRID & ELECTRIC ELECTRONICS

HYBRID AND ELECTRIC VEHICLES INTERVENTION SET

OE 0355

TN



OE 3010



OE 0756



OE 0700



OE 0755

Contents:

- OE0700: hybrid and electric vehicles insulated tools 1000v
- OE3010: voltage safety tester
- OE0755: insulating sheet 3/10th 12.5x1.3m
- OE0756 (x4): spring clip for insulating sheet

HYBRID AND ELECTRIC VEHICLES INTERVENTION MASTER SET

OE 0365

TN



OE 4002



OE 3010



OE 0700



OE 0755

NEW



OE 0798



OE 0797



OE 0796



OE 0785



OE 0795



OE 0756

Contents:

- OE0700: hybrid and electric vehicles insulated tools 1000v
- OE3010: voltage safety tester
- OE0755: insulating sheet 3/10th 12.5x1.3m
- OE0756 (x4): spring clip for insulating sheet
- OE4002: multimeter megohmmeter and insulation tester 1000v cat. III
- OE0795: 4 insulation caps ø10mm L.60mm
- OE0796: 4 insulation caps ø15mm L.100mm
- OE0797: 4 insulation caps ø20mm L.120mm
- OE0785: 4 insulation caps ø35mm L.120mm
- OE0798: 4 insulation caps ø60mm L.140mm



TN

HYBRID AND ELECTRIC VEHICLES INSULATED TOOLS 1000V

OE 0700

Contents:

- OE0701: socket 7mm insulated 1000V 3/8"
- OE0702: socket 8mm insulated 1000V 3/8"
- OE0703: socket 10mm insulated 1000V 3/8"
- OE0704: socket 12mm insulated 1000V 3/8"
- OE0731: socket 13mm insulated 1000V 3/8"
- OE0705: socket 14mm insulated 1000V 3/8"
- OE0706: socket 15mm insulated 1000V 3/8"
- OE0707: socket 17mm insulated 1000V 3/8"
- OE0708: socket 19mm insulated 1000V 3/8"
- OE0709: socket 22mm insulated 1000V 3/8"
- OE0711: insulated ratchet 1000V 3/8"
- OE0712: insulated extension 1000V 3/8"
- OE0713: insulated T-handle 1000V 3/8"
- OE0714: insulated cutter 1000V
- OE0716: 4x100 slotted screwdriver insulated 1000V
- OE0717: 5.5x125 slotted screwdriver insulated 1000V
- OE0718: 1x100 Phillips screwdriver insulated 1000V
- OE0719: 2x100 Phillips screwdriver insulated 1000V
- OE0722: open end wrench 7mm insulated 1000V
- OE0723: open end wrench 8mm insulated 1000V
- OE0724: open end wrench 10mm insulated 1000V
- OE0725: open end wrench 12mm insulated 1000V
- OE0732: open end wrench 13mm insulated 1000V
- OE0726: open end wrench 14mm insulated 1000V
- OE0727: open end wrench 17mm insulated 1000V
- OE0728: insulated combination pliers 1000V
- OE0729: insulated cutting pliers 1000V
- EVA case



Standards: 60900

Compatible with authorizations: B1L, B1VL, B1TL, B2L, B2VL, B2TL, BCL, BEL, BRL, B1XL, B2XL.



MEGOHMMETER 1000V CAT. III & 600V CAT. IV

OE 4002

Specially designed for hybrid and electric vehicles, this device can measure the isolation of electrical equipment, as well as a voltage up to 1000V.

It allows the measurement of DC and AC voltage, DC and AC current, temperature, resistance, capacity, isolation and frequency.

Specifications:

Complies with IEC/EN 61010-1 1000V CAT III, 600V CAT IV.

- 1000V DC Voltage, 750V AC Voltage (TRMS).
- weight: about 390g.
- electrical safety categories: CAT III 1000V, this device can be used in a category 3 medium (shown in the table on the left) at a maximum voltage of 1000V, and in a category 4 medium at a maximum voltage of 600V.

Suitable for the "low voltage" requirements of authorisations: BCL, B2VL, B2TL, B2XL ...





TN

VOLTAGE SAFETY TESTER

OE 3010

Essential for the building industry or electric vehicles, the VAT tester allows to check the absence of voltage on a circuit before starting work in accordance with the NF C18-510 and IEC 61243-3VAT/DDT standards. Our VAT tester is included in our hybrid and electric vehicle intervention roller cabinet, CESVI France certified (OE0370).



Complies standard NF C18-510 and IEC 61243-3VAT/DDT



Specifications:

- continuity test
- differential circuit breaker test 30mA
- moisture and dust proof
- voltage test: 2 at 690V AC/DC and 750V DC with noise emission for range change
- auto AC/DC
- resistance measurements until 2kO
- continuity noise test until 2kO
- frequency of use: DC 50-60Hz and 400Hz
- self-test of probes, cords, displays, 9V battery
- low impedance output: 390kO
- probes center distance: 19mm (for circuit breakers)

Compatible empowerment: B1L, B1VL, B1TL, B2L, B2VL, B2TL, BCL, BEL, BRL, B1XL, B2XL.



BLACK TOUCH POINT IP2X FOR VAT DEVICE

OE 3011

Accessory of OE 3010

IP2X measuring tip with 4 mm female banana coupling, black. Hard tip to scrape varnish, paint, oxidation. Safety 1000 V CAT IV



TN



Standard: IEC 61010-031



RED TOUCH POINT IP2X FOR VAT DEVICE

OE 3012

Accessory of OE 3010

IP2X measuring tip with 4 mm female banana coupling, red. Hard tip to scrape varnish, paint, oxidation. Safety 1000 V CAT IV



TN



Standard: IEC 61010-031





INSULATED TOOLS

INSULATED TOOL INSERTS 1000V

TN

To facilitate the handling of the insulated tools by the technician wearing his P.P.E. (gloves and over-gloves), we have positioned the tools in an adjusted foam insert.

NOTE

Detail-insulated flat keys p.343



INSULATED PLIERS INSERT
5-14mm (10 PCS)

OE 0580

INSULATED RATCHET AND DOUBLE
HEX SOCKET 3/8" INSERT

OE 0595

↔ 5 to 14 mm

↔ 15 to 24 mm

+ Safety: wear indicator
Lifetime warranty



STANDARD INSULATED
PLIERS INSERT (3PCS)

OE 0576

Contents:

- EG0080: foam storage box
- OE0525: insulated angled pliers with premium half-round nose
- OE0527: premium insulated double rack pliers
- OE0528: premium insulated side-cutting pliers



3/8"

TN



To facilitate the handling of the insulated tools by the technician equipped with his P.P.E. (gloves and over-gloves), we have placed the tools in an adapted foam insert.

NOTE

Retail sockets p.343



INSULATED RATCHET AND DOUBLE
HEX SOCKET 3/8" INSERT

OE 0595

↔ 8 to 24 mm





1000V INSULATED PLIERS

PREMIUM INSULATED PLIERS SIDE CUTTER

OE 0528



- HIGH-CAPACITY CUTTING
- COPPER CABLES
- ALU CABLES
- STEEL CABLES

175 mm

Normes : NF EN 60900 / CEI 60900 / NF ISO 5743 / NF ISO 5744 / NF ISO 5745

PREMIUM INSULATED ADJUSTABLE PLIERS WITH DUAL RACK

OE 0527



- ACCESS TO RESTRICTED SPACES
- DOUBLE RACK
- RELIABILITY

250 mm

Normes : NF EN 60900 / CEI 60900 / NF ISO 5744 / NF ISO 8976

INSULATED PLIERS WITH HALF ROUND NOSE PREMIUM ELBOW

OE 0525



- BENDING
- ACCESSIBILITY
- ERGONOMICS
- PRECISION

205 mm

Standards: NF EN 60900 / CEI 60900 / NF ISO 5743 / NF ISO 5744 / NF ISO 5745



- ◀ Chrome-plated finish. Corrosion-resistant.
- ◀ Selection and use of specific steel alloys. Outstanding durability.
- ◀ Wide guards. Prevents sliding towards conductive parts.
- ◀ Robust, unbreakable and irremovable red insulating layer. Total, permanent insulation.
- ◀ Orange outer insulating layer. Non-removable, shockproof, non-flammable. Good grip.
- ◀ Reinforced handle ends.

+ Safety: wear indicator
Lifetime warranty

• The 2 insulating layers are color-coded to allow visual inspection of the entire tool to confirm its suitability for use in an electrical environment, as recommended by UTE18-510 and IEC 60900.

WHEN THE ORANGE LAYER IS DAMAGED AND THE RED LAYER IS VISIBLE = DANGER

- The thickness of the insulating layers is determined according to the weight of the tools, to ensure optimum resistance.
- The tools are designed to withstand extreme temperatures from -20 to + 70°C.
- Each tool is tested to 10,000V AC and approved to 1000V AC for use on low-voltage networks.
- Several checks at each stage of production in addition to IEC 60900 standard checks.





TN

PREMIUM INSULATED FLAT KEYS

Ref	Designation	Length
OE 0506	OPEN END INSULATED WRENCH 6mm PREMIUM	104 mm
OE 0507	OPEN END INSULATED WRENCH 7mm PREMIUM	104 mm
OE 0508	OPEN END INSULATED WRENCH 8mm PREMIUM	107 mm
OE 0509	OPEN END INSULATED WRENCH 9mm PREMIUM	112 mm
OE 0510	OPEN END INSULATED WRENCH 10mm PREMIUM	120 mm
OE 0511	OPEN END INSULATED WRENCH 11mm PREMIUM	130 mm
OE 0512	OPEN END INSULATED WRENCH 12mm PREMIUM	130 mm
OE 0513	OPEN END INSULATED WRENCH 13mm PREMIUM	135 mm
OE 0514	OPEN END INSULATED WRENCH 14mm PREMIUM	140 mm
OE 0515	OPEN END INSULATED WRENCH 15mm PREMIUM	147 mm
OE 0516	OPEN END INSULATED WRENCH 16mm PREMIUM	150 mm
OE 0517	OPEN END INSULATED WRENCH 17mm PREMIUM	157 mm
OE 0518	OPEN END INSULATED WRENCH 18mm PREMIUM	160 mm
OE 0519	OPEN END INSULATED WRENCH 19mm PREMIUM	166 mm
OE 0520	OPEN END INSULATED WRENCH 20mm PREMIUM	172 mm
OE 0521	OPEN END INSULATED WRENCH 21mm PREMIUM	180 mm
OE 0522	OPEN END INSULATED WRENCH 22mm PREMIUM	184 mm
OE 0523	OPEN END INSULATED WRENCH 23mm PREMIUM	186 mm
OE 0524	OPEN END INSULATED WRENCH 24mm PREMIUM	204 mm

NOTE

Insulated tools inserts p.341

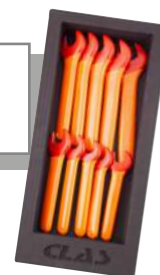

+ Safety: wear indicator
Lifetime warranty



12-FLAT INSULATED SOCKETS

TN

3/8"



Ref	Designation	Length
OE 0231	3/8" DOUBLE HEX INSULATED SOCKET 8mm	45 mm
OE 0232	3/8" DOUBLE HEX INSULATED SOCKET 9mm	45 mm
OE 0233	3/8" DOUBLE HEX INSULATED SOCKET 10mm	45 mm
OE 0234	3/8" DOUBLE HEX INSULATED SOCKET 11mm	45 mm
OE 0235	3/8" DOUBLE HEX INSULATED SOCKET 12mm	45 mm
OE 0236	3/8" DOUBLE HEX INSULATED SOCKET 13mm	45 mm
OE 0237	3/8" DOUBLE HEX INSULATED SOCKET 14mm	48 mm
OE 0238	3/8" DOUBLE HEX INSULATED SOCKET 15mm	48 mm
OE 0239	3/8" DOUBLE HEX INSULATED SOCKET 16mm	48 mm
OE 0240	3/8" DOUBLE HEX INSULATED SOCKET 17mm	43 mm
OE 0241	3/8" DOUBLE HEX INSULATED SOCKET 18mm	47 mm
OE 0242	3/8" DOUBLE HEX INSULATED SOCKET 19mm	47 mm
OE 0243	3/8" DOUBLE HEX INSULATED SOCKET 20mm	46 mm
OE 0244	3/8" DOUBLE HEX INSULATED SOCKET 21mm	48 mm
OE 0245	3/8" DOUBLE HEX INSULATED SOCKET 22mm	49 mm
OE 0246	3/8" DOUBLE HEX INSULATED SOCKET 23mm	49 mm
OE 0247	3/8" DOUBLE HEX INSULATED SOCKET 24mm	49 mm

INSULATED TORX SOCKETS

TN

3/8"

NEW



Ref	Designation	Length
OE 0790	INSULATED SOCKET 3/8" TORX MALE T15	62 mm
OE 0791	INSULATED SOCKET 3/8" TORX MALE T20	62 mm
OE 0792	INSULATED SOCKET 3/8" TORX MALE T25	62 mm
OE 0793	INSULATED SOCKET 3/8" TORX MALE T30	62 mm
OE 0794	INSULATED SOCKET 3/8" TORX MALE T40	62 mm



NOTE

Insulated socket inserts p.341





FEMALE HEX SOCKETS

TN

1/4"

NEW



Ref	Designation	Length
OE 0265	1/4" INSULATED FEMALE HEX SOCKET 4mm	38 mm
OE 0266	1/4" INSULATED FEMALE HEX SOCKET 5mm	38 mm
OE 0267	1/4" INSULATED FEMALE HEX SOCKET 5.5mm	38 mm
OE 0268	1/4" INSULATED FEMALE HEX SOCKET 6mm	38 mm
OE 0269	1/4" INSULATED FEMALE HEX SOCKET 7mm	38 mm
OE 0270	1/4" INSULATED FEMALE HEX SOCKET 8mm	38 mm
OE 0271	1/4" INSULATED FEMALE HEX SOCKET 9mm	38 mm
OE 0272	1/4" INSULATED FEMALE HEX SOCKET 10mm	38 mm
OE 0273	1/4" INSULATED FEMALE HEX SOCKET 11mm	38 mm
OE 0274	1/4" INSULATED FEMALE HEX SOCKET 12mm	38 mm
OE 0275	1/4" INSULATED FEMALE HEX SOCKET 13mm	38 mm
OE 0276	1/4" INSULATED FEMALE HEX SOCKET 14mm	38 mm



MALE HEX SOCKETS

TN

1/4"

NEW



Ref	Designation	Length
OE 0280	1/4" HEX INSULATED MALE SOCKET 3mm	50 mm
OE 0281	1/4" HEX INSULATED MALE SOCKET 4mm	50 mm
OE 0282	1/4" HEX INSULATED MALE SOCKET 5mm	50 mm
OE 0283	1/4" HEX INSULATED MALE SOCKET 6mm	50 mm
OE 0284	1/4" HEX INSULATED MALE SOCKET 7mm	50 mm



INSULATED RATCHET 1000V 3/8" PREMIUM

TN

OE 0761

+ Safe operation!

NEW



Specifications:

- standards : NF EN 60900 / CEI 60900 / NF ISO 1174-1 / NF ISO 3315
- overlap collar
- accessory release button
- fixing hole (working at height)
- 72 teeth mechanism for a 5° angle recovery
- resistance to tearing : 500 Newtons
- length : 215 mm
- weight : 300g



INSULATED RATCHET 1000V 1/4" PREMIUM

TN

OE 0786

NEW



Specifications:

- standards: NF EN 60900 / CEI 60900 / NF ISO 1174-1 / NF ISO 3315
- overlap collar
- accessory release button
- mounting hole (working at height)
- 72-tooth mechanism for 5° angle recovery
- pull-out strength: 500 Newtons
- length: 215 mm



INSULATED RATCHET 1000V 1/2"

TN

OE 0568





INSULATED EXTENSION 3/8" 140mm PREMIUM

TN

OE 0738

+ Safety



NEW

Specifications:

- length: 140mm
- Standard EN 60900 / IEC 60900 / ISO 1174-1 / ISO 1711-1: 1000 V AC and 1500 V DC
- pull-out strength: 500 Newtons



1/4" INSULATED LONG EXTENSION 1000V PREMIUM

TN

OE 0788



NEW

Specifications:

- length : 166mm
- standard EN 60900 / IEC 60900 / ISO 1174-1 / NF ISO 3316



INSULATED TORQUE WRENCH 3/8" 10-50Nm

TN

OE 0766

This tool is specifically designed for use on electric or hybrid vehicles. To ensure optimal use, the insulation is as thin as possible while guaranteeing a grip and a good grip with the gloves. It is composed of a double layer of insulation of 2 different colors, allow at first glance to identify if the insulation is damaged and therefore rendered unusable. Electrically insulated, it is controlled at 10000 V and certified at 1000 V AC

+ Supplied with calibration certificate



NEW

Complies with IEC60900 and EN6789 standards
Length: 315mm



INSULATED HANDLE WITH FLEXIBLE ROD AND MAGNETIC TIP

TN

OE 0759

Insulated tool 1000 V, 440 mm articulated magnet, allows to recover screws or nuts up to 120g

+ Safety, practical

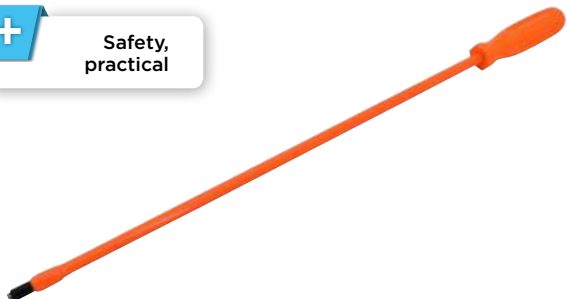

Specifications:

- 1000V insulated tool
- electrical standard : CEI 60900 1000V AC , 1500V DC
- total length: 560mm
- articulated rod length : 440mm
- Ørod: 10mm
- weight: 130g



ISOLATING LEVER 1000V

TN

OE 0760

1000V insulated disassembly lever. Allows the removal of sensitive parts on electric vehicles. Avoids damage to parts that mark easily (e.g. plastic trim or covers)

+ Safe operation! Save time!



Specifications:

- 1000 V insulated tool
- electrical standard : CEI 60900 1000V AC , 1500V DC
- total length : 190 mm





INSULATED FLAT-BLADE SCREWDRIVERS

Specifications:

- standard: EN 60900 / IEC 60900 / ISO2380-1 / ISO8764-1.
- blade: high performance hardened steel: chrome molybdenum.
- treatment: insulation sheath integral with the handle, directly injected on the blade.
- dimension: L.70mm



+ Rotating handle end

OE 0768	FLAT INSULATED 2x70 SCREWDRIVER 1000V PREMIUM
OE 0769	FLAT INSULATED 4x120 SCREWDRIVER 1000V PREMIUM
OE 0772	FLAT INSULATED 6.5x150 SCREWDRIVER 1000V PREMIUM
OE 0774	FLAT INSULATED 8x200 SCREWDRIVER 1000V PREMIUM
OE 0776	FLAT INSULATED 10x250 SCREWDRIVER 1000V PREMIUM
OE 0777	FLAT INSULATED 12x200 SCREWDRIVER 1000V PREMIUM



INSULATED PHILLIPS SCREWDRIVERS

Specifications:

- standard: EN 60900 / IEC 60900 / ISO2380-1 / ISO8764-1.
- blade: high performance hardened steel: chrome molybdenum.
- treatment: insulation sheath integral with the handle, directly injected on the blade.
- dimension: L.75mm



+ Rotating handle end

OE 0778	PHILLIPS INSULATED NO 4x75 SCREWDRIVER 1000V PREMIUM
OE 0781	PHILLIPS INSULATED N2 6x125 SCREWDRIVER 1000V PREMIUM
OE 0783	PHILLIPS INSULATED N4 10x200 SCREWDRIVER 1000V PREMIUM



TORX INSULATED T30 SCREWDRIVER 1000V PREMIUM

OE 0561

The screwdriver has a perfectly round handle end providing to the user an excellent grip and working comfort. This end of the handle is also rotatable which facilitates the tightening approach: the rotating ball of the handle is held in the palm and the fingers control the rotation.

Thanks to the cutting of the blade, there is no extra thickness of insulation on the upper part of the blade to reach the screws housed in fine wells.

+ Rotating handle end

Specifications:

- standard: EN 60900 / IEC 60900 / ISO2380-1 / ISO8764-1.
- blade: high performance hardened steel: chrome molybdenum.
- treatment: insulation sheath integral with the handle, directly injected on the blade.
- dimension: L.225mm

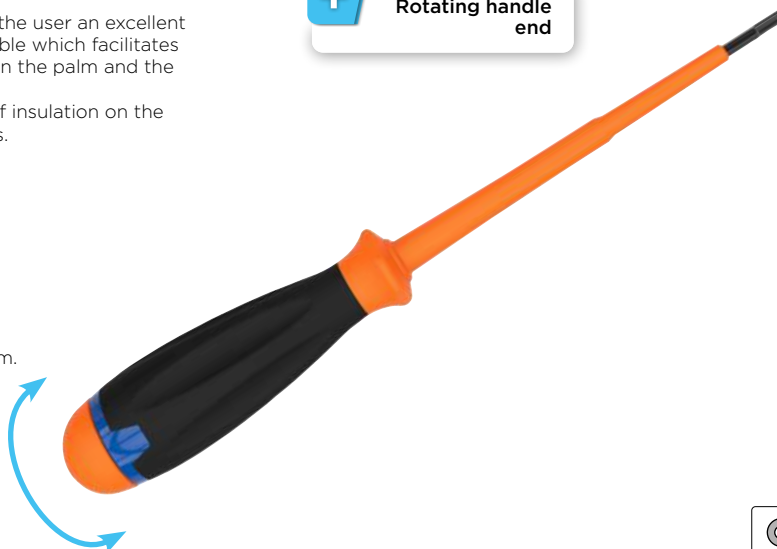

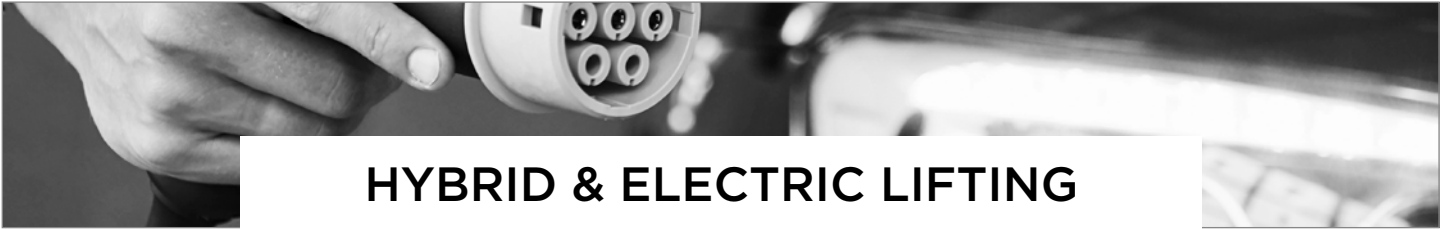

HYBRID & ELECTRIC LIFTING

TE

LIFTING TABLE 1000kg FOR EV BATTERY AND HEAVY ORGANS

OH 1301

This table is specially designed for the removal and re-installation of heavy components with a maximum load of 1T (electric vehicle battery and/or drive train).

Versatile, it will be able to adapt to all your needs thanks to its many adjustments and its optional supports on request.

A hydropneumatic control allows effortless, fast and precise height control. The descent is secured by the "dead man" function which requires 2 simultaneous actions of the operator. This function will be automatically stopped in case of problem concerning the operator. The platform is fully mobile in relation to its frame and has 104 M10x1.5 drilled and tapped points, which can be used to receive various accessories (available on request).



+/- 10cm

+/- 5cm

Hydropneumatic foot pump

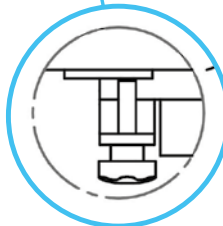
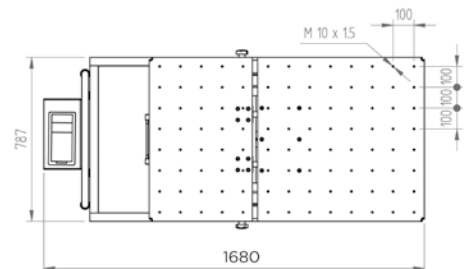

Tilt adjustment

+/- 5%

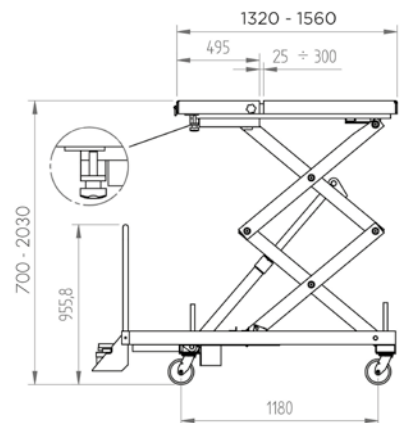

Specifications:

- length: 1680mm
- width: 780mm
- height: 1000mm
- minimum tray height: 730mm
- maximum height of the tray: 2065mm
- maximum shelf length: 1520mm
- minimum tray length: 1355mm
- climb time: +/-60s
- descent time: +/-20s
- 4 swivel braking wheels: 130mm
- 4 handles place around the table for optimal ease of use when adjusting

- the load to the stand.
- weight: 385kg
- Adjustments :
- the tray is deployed in three lockable positions for a max. area of 1520mmx730mm1520mmx730mm. It is tapped M10x1.5 to receive different accessories (available on request).
- table flatness is adjustable in 2 points for high positioning accuracy (tilt degree +/- 5%)
- the tray is movable in translation and swivelable for greater precision during the element support.





MUST-HAVE

LIFTING TABLE 1500kg FOR EV BATTERY AND HEAVY ORGANS

OH 1500

This table is specially designed for the removal and support of heavy parts not exceeding 1.5T max load, such as a battery of electric vehicles or a powertrain. Versatile, it will adapt to all your needs thanks to its many settings and optional supports on request. Due to its robust design, it has been designed to meet the needs of intensive use.



STATIC TABLE - PERSONAL SAFETY



+ High load 1500Kg
High precision of settings

Specifications:

- h. min.: 580mm
- h. max.: 1800mm
- max. height on safety catches: 1740mm
- rise time (depending on the load) : 70-110 sec (example: 73 seconds with a load of 457 kg)
- lowering time (depending on the load): +/- 30 sec (example: 34 seconds with a load of 457 kg)
- platform length: 1400-1600mm
- platform width: 800mm
- overall length of telescopic frame: 1650mm to 1850mm
- equipped with two wheels made of aluminium and polyurethane : 2 fixed and 2 swivel with brake
- PU wheels
- max hydraulic pressure : 190bar
- pneumatic supply : 6-8bar
- weight : 430kg



THINK ABOUT IT!

SET OF 12 ADJUSTABLE ROUND RUBBER FOR LIFT TABLE 48MM

CO 1160



INSULATING SHEET 3/10th 12.5x1.3m

OE 0755





A pneumatic control system allows effortless, fast and precise control of the height. The safety is ensured by a system of pneumatically operated side racks.

The plate unfolds for a maximum surface of 1440-1640mmx800mm, and is tapped M10x1.5 to receive various accessories allowing the removal of organs. With the help of 2 screws driven by a 17mm hexagon, it is possible to act on the flatness of the table +/- 5%, and laterally +/- 3,5cm, for a great precision of positioning.

The telescopic frame of the table from 1650mm to 1850mm allows the reception of very large batteries.

Two lateral reservations under the frame of 170mm wide spaced of 750mm, allow the transport of the table with a forklift.

TABLE IN OPERATION - PERSONAL SAFETY



ADAPTS TO ALL LIFT AND PERSONNEL HEIGHTS

SAFE DESCENT

- controlled descent speed > pressure regulator
- support retraction system of the handle



UNIVERSAL TABLE
- adapts to all battery types

1

TILTING

Tilt adjustment
+/- 5%



2

TRANSLATION

Translation adjustment
+/- 3.5cm



3

SPACING

Gap adjustment
+/- 20cm



1.5T



CHARGING

Charging cable, 16A, 1 phase, 7.2kw for electric vehicle. Type 2 (IEC 62196-2) female and male plug, length 5m.

TN

CHARGING CABLE T2-T2 7.2kW 5m

OE 2041

NEW



Specifications:

- 7.2KW
- 16 A
- 1 phase
- length : 5m
- plug : type 2



7.4kW

NO WARRANTY

Charging cable, 16A, 1 phase, 7.2kw for electric vehicle. Type 2 (IEC 62196-2) female and male plug, length 5m.

TN

CHARGING CABLE T2-T2 22kW 5m

OE 2043

NEW



Specifications:

- 22KW
- 32 A
- 3 phases
- length : 5m
- plug : type 2



22kW

NO WARRANTY

PORTABLE CHARGER FOR ELECTRIC AND HYBRID VEHICLE T2 3.6kW 5m

TN

OE 2046



NEW



Specifications:

- IP66: water and dust proof
- IK 10: resists the shock of a 5kg mass falling from 40cm.
- plugs: type 2 & type E
- max output current: 16 A.
- switchable current: 10A, 13A and 16A.
- total length: 5M.



2 WARRANTY



CHARGING STATION 11kW REEL 6m

OE 2047

plug-and-play charging unit.
For both private and public use.
For your installation requirements, please do not hesitate to contact us.

This station offers:

- elegant and compact design
- simplified operation
- digital display showing essential information: charging power, current in real time, charging time and charging capacity

NEW

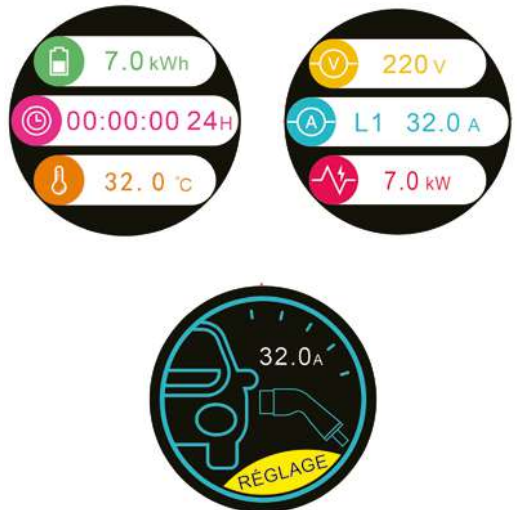

+ No access restrictions (free)

Specifications:

- height: 437mm
- width: 217mm
- thickness: 74mm
- IP66
- standard EN 61851-1

Content:

- 11kW terminal block
- 6m cable with TS plug
- One wall hook

ADVANTAGE

- Protection against :
- circuit overcurrents
 - leakage circuits
 - earth leakage
 - overheating
 - thunder protection

NOTE

Imperative installation by an IRVE-certified electrician.
Panel protection not supplied:
- 25A type A or B differential switch
- 20A C-curve 10kA circuit breaker

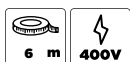
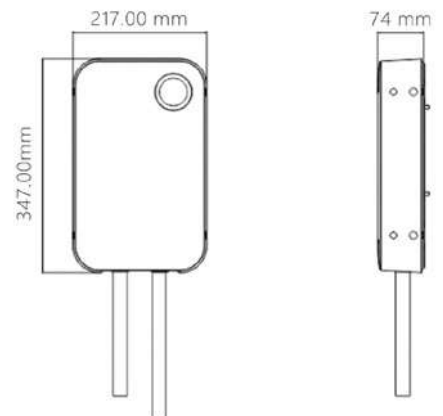

11kW





TN

INJECTOR CLEANER FOR HYBRID PETROL VEHICLES

CO 1082

NEW

+ No disassembly - mix directly with fuel

Specifications:

- treats up to 80 liters with a 300ml dose
- preventive and curative formula
- does not damage injection circuit seals

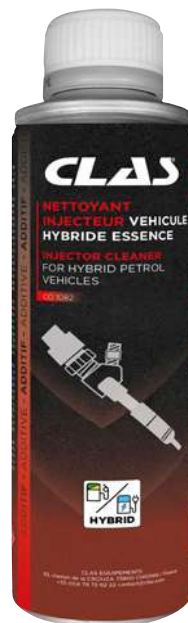

EGR VALVE AND CATALYST CLEANER FOR HYBRID VEHICLES

CO 1084

NEW

+ Ideal before technical inspection

Specifications:

- treats up to 80 liters with a 300ml dose
- eliminates deposits
- reduces consumption



300ml ENGINE CLEANER BEFORE DRAINING FOR HYBRID VEHICLES

CO 1083

NEW

+ Directly into the oil filler

Specifications:

- cleans the oil circuit and eliminates deposits
- fluidizes oil for easier draining
- cleans and silences hydraulic valve lifters
- neutralizes harmful acids in the engine



BODY REPAIR



HEADLIGHTS

P.356



AUTO GLASS

P.359



**BODYWORK
HANDLING**

P.369



**BODYWORK
LIFTING**

P.371



**ROLLER
CABINET**

P.374

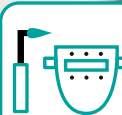

**WELDING &
CUTTING**

P.375



**PULLING &
RESTRAINING**

P.376



**PLASTIC
REPAIRING**

P.382



PAINTING

P.385



**DOORS
& CABIN**

P.391



**BODYWORK
STAPLES**

P.392

CHOOSING THE HEADLIGHT ADJUSTMENT DEVICE

Points to watch

Before choosing a headlight adjustment device, there are several questions to ask yourself:

- What type of vehicle am I likely to be working on? LV, LCV, HGV, motorcycle?
- How often do I use it?
- do I have a dedicated place in my workshop for this service, and does my location meet the requirements, or do I need to clear the area accordingly? (e.g. laying a rail if it's not flat).

The different types of light in an optical compartment :

- halogen light
- xenon light
- LED light
- laser light
- "intelligent" light



LEARN MORE

MATRIX - DLA - ILS : Added segments

The evolution of headlights has led automobile manufacturers to create lighting modules with different construction characteristics.

The projections established by current regulations remain unchanged (low, high and fog lights), but a fourth projection must be controlled depending on the vehicle manufacturer.

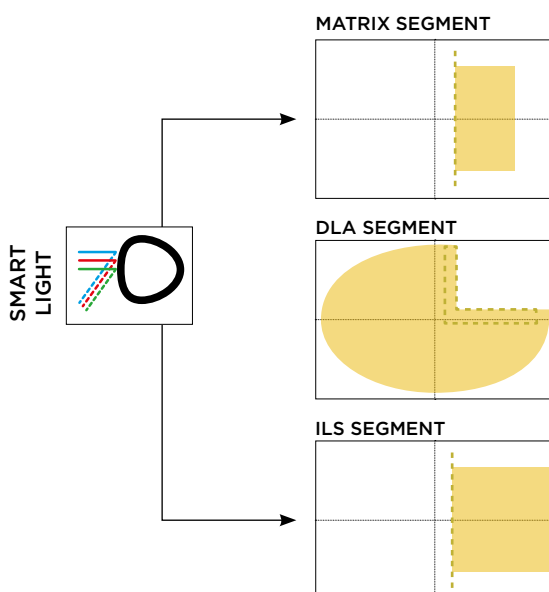
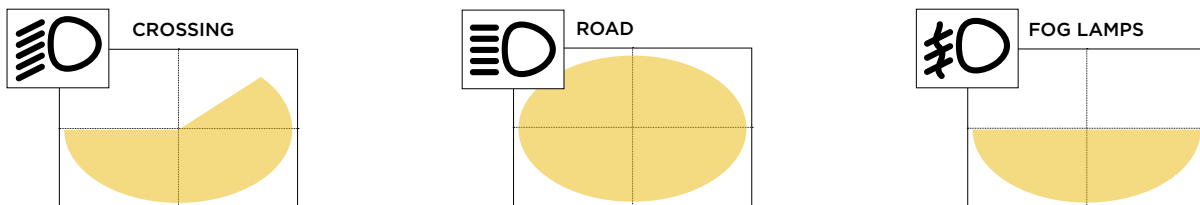

Adjustment: diagnostics takes over

If segments have been added to the vehicle, the prerequisite for adjusting and checking the position is to connect to the control unit via diagnostics at the OBD socket and set the adjustment mode. The reference parameters for adjusting the segments to be added are defined by the car manufacturer and the vehicle being tested. Any operation carried out on the phrases without connecting to diagnostics will be cancelled when the vehicle is started up.

Update 2020: new segments!

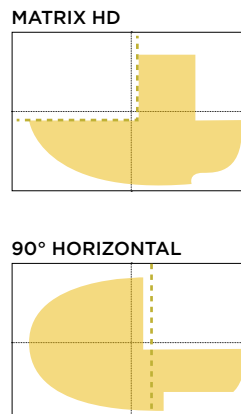

With the evolution of cars, and indeed of their headlamps, new segments have recently appeared, and our AC 3010 headlamp adjuster will enable you to adjust them.

Reminder: the headlamp needs to be updated annually. If you purchased your device before 2020, these new segments will be available with the update.



COMPARATIVE TABLE



REF	AC 2005BL	AC 2013	AC 3010
Vehicle type			
Intensity of use			
Aligner	Mirror	Double laser	Double laser
Beam reading	Sight	Sight	Camera
Digital luxmeter	Yes	Yes	Yes
Power supply	9V battery	Battery 1.5V x3 + 9V	12V battery
Light type	Halogen, Xenon, Led	Halogen, Xenon, Led	Halogen, Xenon, Led, Led Matrix, Laser
Display type	Digital	Digital	5.7° color LCD touchscreen
Optional rail	No	Yes	Yes





HEADLIGHT ADJUSTMENT

STANDARD HEADLIGHT ADJUSTMENT DEVICE

AC 2005BL



Specifications:

- mirror type aligner
- digital luxmeter
- alu column (collapsible) graduated from 20 to 150cm
- sliding regulating mechanism
- metal housing with tilt adjustment
- power supply: 9V battery (supplied)
- dimensions: L.712xW.580xH.1810mm



Polycarbonate lens



TN

DUAL LASER HEADLIGHT ADJUSTMENT DEVICE

AC 1203



Graduation



Glass lens



Precise laser adjustment to the optics



TN

OPTIONAL

RAILS AND WHEELS KIT

SA 3032

Accessory of AC 3010/AC 1203/
PE 6006M/PE 6006T



TN

Specifications:

- laser-type aligner (SA2037) compliant with standard EN 60825
- digital luxmeter
- alu column (collapsible) graduated from 20 to 150cm
- sliding regulating mechanism
- thermoplastic housing with tilt adjustment
- laser aligner power supply: 3 1.5V batteries (supplied)
- dimensions: L.712xW.580xH.1810mm
- UTAC NFR 63801 standard

Functions:

- control and measurement of the closing mechanism 0-4%
- control of the lateral adjustment $\pm 5\text{cm}/10\text{m}$
- measurement of the illumination intensity 0-150klux/1m, 0-240lux/25m
- intervention on headlights (xenon, halogen, LED...), anti-fog





MUST-HAVE

TN

DUAL LASER/CAMERA HEADLIGHT ADJUSTER

AC 3010

+ No misinterpretation

- checks and carries out automatic diagnostics of dipped, full beam and anti-fog beams regardless of the type of headlight: LED (Matrix, Intelligent...), xenon, halogen...
- allows the beam to be checked and automatically measured (using a camera) when lowered and in lateral mode. It also allows you to measure the illumination intensity.
- centering of the housing using cross-form lasers.
- conforms to the standard UTAC NFR 63-801

Specifications:

- measuring range:
 - Top and bottom alignment 0-6% (accuracy +/- 0,1%)
 - Right and left alignment 0-10% (accuracy +/- 0,2%)
- light intensity: 150kcd
- 360° rotating aluminum column
- counterweight upward and downward motion
- 3-axis inclinometer compensating for irregularities in the ground electronically
- adjustable castors compensating for significant differences in ground levels
- housing height sensor
- ICD color tactile 5.7" screen
- integrated printer: Registration number/date/test result
- 12V rechargeable battery
- automatic standby
- simple and quick software updates (using a USB key)
- connections: RS232
- communication protocol: Net1, Net2
- dimensions: L.695xI.660xH.1780mm



OPTIONAL

TN

RAILS AND WHEELS KIT

SA 3032

Accessory of AC 3010/
AC 2013/PE 6006M/PE
6006T



NO
WARRANTY

2
WARRANTY

VAG HEADLIGHT ADJUSTMENT TOOL

TN

OM 0416

Designed to tighten/loosen the adjustment knob specific to VAG front headlights.



Double hex
Ø13mm with guide

Applications:

Audi: A4 8K, A5 8T, A6 4G
VW: Passat, Touareg

2
WARRANTY



HEADLIGHT RESTORATION

3" MINI POLISHER KIT Ø75mm

TN

OP 1429



Specifications:

- speed: 3,200rpm
- pad size: 75mm
- spindle thread: M6x100
- air consumption: 170l/min
- length: 115mm

SA1429 : velcro sanding pad Ø75mm

Connector supplied



RENOVATION KIT FOR 2 HEADLIGHTS

TN

RP3000

Provides a fast, easy and efficient headlight renovation. No tools or sanding required. 3 pre-saturated wipes allow for a complete renovation of both headlights.

- 2 cleaning wipes (one for each headlight).
- 1 finishing and protective wipe to restore the shine of the headlights.



Product only available in french.



VARNISH SPRAY 1K 400ml

TN

CO 1004

Enables varnishing and protecting topcoats while providing a high-gloss finish. Excellent for body parts (hoods, doors, fenders, rocker panels, rims, etc.). Transparent, UV and scratch-resistant.

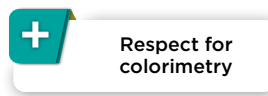

Also available in box of 12





GLASS REPAIRING

WINDSCREEN WIPER REMOVER

OC 1700BL

Lets you handle all supports with very effective force.

B.LINE
BUDGET SOLUTION

+ Small size

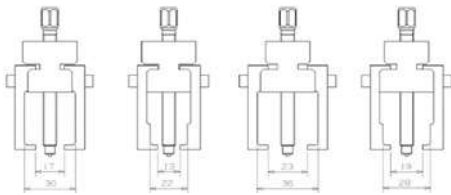

TN

WINDSCREEN WASHER NOZZLE CLEANING TOOL

EG 0002



Specifications:

- dimensions:
950mm with protective cap
870mm without protective cap
- tool diameter: 6mm
- cleaning needle and tracer needle: 0.5mm
- needle length: 13mm



TN

UNIVERSAL WINDSCREEN WIPER EXTRACTOR

OC 1710



Telescopic push screw adjustment.



Contents:

- 4 cage extractors Ø26-30mm/Ø31-35mm/Ø36-40mm/Ø36-46mm, internal 45mm, hexagonal drive 12mm
- 1 extractor with internal grips 18-40mm, internal 45mm, hexagonal drive 12mm



TN





GLASS CUTTING

HOLLOW STARTING NEEDLE TN
OC 4500

NO WARRANTY

WIRE THREADER TN
OC 4100

NO WARRANTY

WIRE GUIDE TN
OC 6000

75mm length of flat side

NO WARRANTY

SAWING WIRE TN
0.8mmx0.8mmx44m
OC 2100

Specifications:
 • resistance: 110kg / 1078N

44 m **NO WARRANTY**

TRIANGULAR WIRE REEL 50m TN
OC 3401

NO WARRANTY

CUTTING WIRE TN
0.7mmx0.7mmx44m
OC 3100

Specifications:
 • resistance: 95kg / 931N

44 m **NO WARRANTY**

KIT OF 4 WINDSCREEN PROTECTORS TN
OC 1409

NO WARRANTY

PAIR OF PULLING HANDLES TN
OC 2900

Quick-lock handles

2 WARRANTY

2-HANDLE LINE CUTTER KIT TN
OC 1500

A set of 2 handles allows to pull the inserted wire in the joint with the help of a needle.

Contents:
 • OC2900: pair of pulling handles
 • OC2100: sawing wire 0.8mmx0.8mmx44m
 • OC4500: hollow starting needle

44 m





TN

WINDSCREEN REMOVAL KIT

OC 1401

Central suction cup with spring-loaded return lever mounted on swiveling arm.

The device replaces the second technician to pull the wire to be cut inside the vehicle, fixed with the suction cup in the center of the windshield, the spring system pulls the wire step by step while the technician pulls the wire from outside.

+ 1 single operator

Contents:

- OC1399: 1 suction cup
- OC2100: 1 reel 22m braided line
- OC4500: 1 starting needle
- OC2900: 2 pulling handles



RATCHET WINDSHIELD CUTTER

OC 6498

Accessory of OC 2900/OC 4500/OC 0600/OC 0200/OP 0500/OP 0714/OP 5060/OC 2100/OC 3100/OC 3401/OC 1100

This single suction cup kit with pump allows, thanks to the nylon thread, to remove the windcreens without damaging the gaskets, so it is not necessary to disassemble them. The gasket is cut by pulling a wire (or cable) operated by a ratchet system. This suction cup, due to its small size, allows you to work on the windcreens, rear windows and the side panels of a vehicle. Easy to use, it allows a quick intervention (a few minutes) by a single operator and without any physical effort.

This tool has been certified by a large number of car makers.

+ 1 operator and effortless cutting



Specifications:

- universal: compatible with nylon and steel wire (all types: braided, square and triangular)
- traction capacity 200kg (compared to 100kg for steel cable)
- up to 8 cuts before changing the nylon thread

Contents:

- mono suction cup cable traction system with ratchet
- OC4100: windscreen line inserter
- nylon wire drawer 25m
- protective glasses



NYLON WIRE DRAWER 50m

OC 1100





TN

MOTORIZED WINDSHIELD CUTTING KIT

OC 1402

Electrically assisted cutting system on all types of windshields by a single operator.

This tool allows you to work alone and without effort thanks to its electric assistance system. It cuts all types of windshields efficiently and effortlessly.

It is thus possible to remove "encapsulated" windows (windshield, window, quarter glass) without damaging the seal or the support.

The risks of touching the window and the various trimmings are reduced, guaranteeing a fast, precise and especially effortless work thanks to the 12V motor to be coupled to the vehicle's power supply. Moreover, thanks to its wireless remote control, the operator keeps control of all the cutting steps, both inside and outside the vehicle.

NEW

+ No effort when cutting



Contents:

- motor equipped with its suction cup, powered by a standard plug (cigarette lighter 12v, length 1.7m) supplied
- wireless remote control (for viewing and controlling wire tension)
- suction cup with attachment hook (to be positioned outside the window)
- suction cup with return pulley (to be positioned inside the vehicle)
- nylon thread spool

2 WARRANTY

HAND CUTTER FOR WINDSCREEN CUTTING

OC 0200

Ergonomic sheathed knife for cutting the windshield seal by pulling the blade.

Specifications:

- grooved metal
- t-shaped handle, hose



Supplied with 25mm blade



OC 7025	25mm BLADE SET (5 PCS)
OC 7038	38mm BLADE SET (5 PCS)

NO WARRANTY

PNEUMATIC KNIFE

OP 0500

- oscillations/min: 20000
- length: 192mm
- supply pressure: 6.2bar
- consumption: 113l/min
- net weight: 1kg



Supplied with conector and 1 OP0557 blade

OP 0557	STRAIGHT BLADE 57mm	Spare part of OP 0500
OP 0535	STRAIGHT BLADE 35mm	Accessory of OP 0500
OP 0508	SCRAPER BLADE 8mm	Accessory of OP 0500
OP 0590	STRAIGHT BLADE 90mm	Accessory of OP 0500
OP 0536	U-SHAPED BLADE 36mm	Accessory of OP 0500

OP 0536



OP 0535



OP 0557



OP 0508



OP 0590



2 WARRANTY



ROPE INSERTION TOOL

TN

OC 0501



Length of the insertion rope: 6m



For unglued windshields.



WINDSCREEN GASKET ROLLER TOOL

TN

OC 0502

With its selection of ends, it allows you to position the gasket.



For unglued windshields.



Blade width: 38mm
Blade height: 19mm

RETRACTABLE SCRAPER

OC 0305

RETRACTABLE SCRAPER + 100 BLADES

OC 0306

OC0305 : 1 x retractable scraper
OC5497 : 1 x 100 scraper blade set

TN



SCRAPER AND UTILITY KNIFE SET

TN

OC 0302



Contents:

- 1 cutter
- 5 straight blades 12mm (OC5301)
- 5 straight blades 16mm (OC5302)
- 5 straight blades 20mm (OC5303)
- 5 bevelled blades 16mm (OC5304)
- 5 trapezoidal blades (OC5305)



SCRAPER WITH HANDLE + 100 BLADES

TN

OC 0303



Blade width: 38mm
Blade height: 19mm

OC0304 : 1 x scraper with handle
OC5497 : 1 x 100 scraper blade set

OC 0304 SCRAPER WITH HANDLE



UNIVERSAL GEL FOR ATTACHING RAIN SENSOR/LIGHT SENSOR (single dose)

TN

OC 2204



100 WINDSCREEN PREPARATION TOOL SET

TN

OC 0301





CARTRIDGE AND BAGS GUN 340mm 12:1

TN

OC 5071

For the application of silicons, adhesives and putties in 310ml cartridges and 300 and 400ml bags.



Supplied with 1 plastic spout SA5065

Specifications:

- aluminum handle, body and ring
- ratio: 12:1
- max. thrust: 4000Nm
- total length: 340mm



AIR CAULKING GUN

TN

OP 5061

For the application of silicons, glues and putties with 310ml cartridges.



Connector supplied

Specifications:

- aluminum body
- total length: 325mm
- 1/4" connection
- supply pressure: 5bar
- progressive trigger to enable speed control



PNEUMATIC GUN FOR 370mm CARTRIDGES AND BAGS

TN

OP 5060

For silicons, glues, putties application with 310ml cartridges and 300,400 and 600ml bags.

Specifications:

- aluminum body and ring
- total length: 470mm
- length: 370mm
- height: 270mm
- sound level: 80dB
- air pressure inlet regulator from 4 to 8bar (10bar maximum) with 1/4" connection
- valve strength: 160kgf to 8bar
- progressive trigger to enable speed control

+ Precise cable with the regulator



Connector and plastic spout supplied



12 CRIMPING NOZZLES 6-12mm Ø15x1,5mm L.100mm

CO 1050



Output waist width: adjustable from 6 to 12 mm
Adjustable deformation from 0 to 9 mm
Possible cutting right side/ left side

12 V-SHAPED NOZZLES 10mm Ø15x1,5mm L.58mm

CO 1052



12 TAPERED NOZZLES Ø15x1,5mm L.105mm

CO 1056



TN



SCREEN ADHESIVE CARTRIDGE 290ml

TN

CO 1041

Permits adhesion of screens, rear windows, side windows etc.

Specifications:

- MS polymer
- integrated primer
- application width 10 to 14mm
- drying: 2 hours at heart (at 20°C)
- hardness: SHORE 60

+ Use without primary



NOTE

Electronic leak detection stethoscope p.368



Also available in box of 12





GLASS HANDLING

PAIR OF SUCTION CUPS Ø115mm

OC 0550BL

Essential for positioning and gluing all kind of windscreens.

Specifications:

- tilting suction cups to adapt to various glass contours
- lever lock
- carrying handle
- capacity: 60kg
- suction cups Ø115mm
- supplied with fast-ratchet sling
- sling length: 4.7m
- sling length: 2.5cm



B.LINE
BUDGET SOLUTION



TN



PAIR OF SUCTION CUPS Ø120mm

OC 0600

Essential for positioning and gluing all kind of windscreens.

Specifications:

- swappable suction cups to suit various glass shapes
- lever lock
- carrying handle
- capacity: 120kg
- suction cups Ø120mm
- supplied with fast-ratchet sling
- sling length: 5m

+ Working comfort



Contents:

- SA6958: Ø120mm suction cups
- SA6959: 5m strap with pawl



TN



6 BODYWORK SUCTION CUP SET Ø85mm

OC 0667



Specifications:

- suction cup Ø85mm
- stand L.180mm
- holding width: 50mm
- bearing surface width: 80mm
- height of the stand adjustable to 32mm
- material: polyethylene and rubber
- adjustment using thumb screw system.



TN

PUMP SUCTION CUP HGV Ø254mm CAPACITY 140kg

OC 0662

Vacuum pump with brass piston



TN

MUST-HAVE

PAIR OF SUCTION CUPS Ø140mm

OC 0611

+ Increased security

Specifications:

- tiltable suction cups to adapt to different window shapes
- locking by lever
- Handling grip
- capacity: 120kg
- suction cups Ø140mm



Suction cup Ø140mm





TN

BODYWORK STAND WITH TARPAULIN

OC 0724

This multifunctional folding mobile easel is ideal for all bodywork and glazing work.

Equipped with a tarpaulin to hold tools or other items, it can also be used to protect parts such as hoods, bumpers, wings, etc...

NEW

+ Foam protection



Specifications:

- capacity: 270kg
- folding galvanized steel structure (Ø32mm x 1.2mm).
- height: 1040mm
- width: 1080mm
- working range from 680 to 1040mm (adjustable feet)
- PU support plug
- weight: 6.4kg



ADJUSTABLE BODYWORK STAND WITH TOOL HOLDER

OC 0713

Specially designed foldable trestle to support the bodywork parts (bonnet, door, bumpers...etc.)

Integrated tool tray
6-position setting

Specifications:

- Anti-scratch plastic support stands
- Stand width: 930mm
- 6 positions for spacing the stands:
- 300mm (Height: 1090mm)
- 405mm (Height: 1060mm)
- 515mm (Height: 1015mm)

- 625mm (Height: 950mm)
- 730mm (Height: 880mm)
- 845mm (Height: 775mm)
- Tray dimensions: L.690xW.340xD.36mm
- Dimensions of the folded trestle: L.1110xW.75xD.1125mm



UNIVERSAL TELESCOPIC BODYWORK STAND 23-138cm

OC 0716

+ Does not scratch paintwork

Specifications:

- width: 22.5 à 138cm
- height: 84 à 132cm
- anti-slip rubber-sheathed support arm

- support arm length: 86cm
- support arm width: 8cm
- capacity: 100kg
- 4 swiveling wheels, 2 of which have brakes



PARTS/WINDSCREEN/COVERS DOLLY

OC 6041

Specifications:

- independent, sliding, foam covered support bars
- height of support bars: 590mm

- 5 modifiable compartments to hold the parts in total safety
- 2 of the wheels have brakes
- Ø wheels: 90mm





GLASS REPAIRING

WINDSCREEN REPAIR KIT

OC 2203

+ Easy to use



Contents:

- SA4104: UV Lamp 12V rechargeable
- OC2202: Repair resin 10ml
- OC8064: Finish resin 5ml
- SA4108: 1 polish
- SA4109: 1 gel for suction cups
- SA4105: 1 box UV sheets
- SA4107: 1 inspection lens
- 1 scraper
- SA4106: 1 injector support
- OC2205x2: injectors
- 1 box of 10 blades
- 1 lighter
- 1 user guide

2
WARRANTY

INJECTOR

OC 2205

Spare part of OC 2203



NO
WARRANTY

TN

REPAIR RESIN 10ml

OC 2202



10
ml

NO
WARRANTY

TN

FINISH RESIN 5ml

OC 8064



5
ml

NO
WARRANTY

TN

CARBIDE BIT Ø1mm

OC 8067



NO
WARRANTY

TN

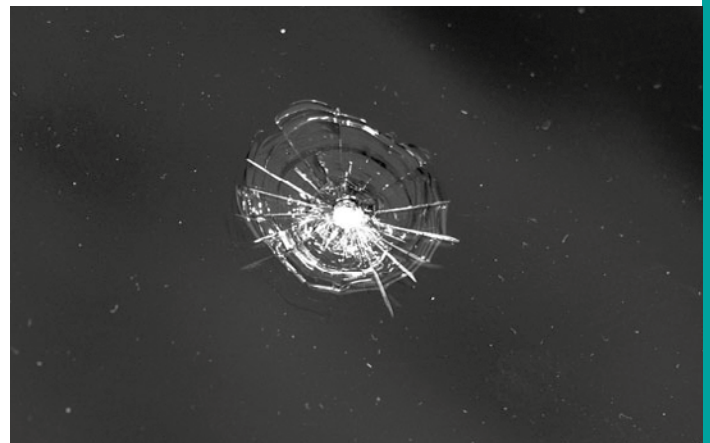



WINDSHIELD IMPACT SELF-REPAIR KIT

OC 2210

This tool allows the semi-automatic injection of roughing and finishing resins for "repairable" impacts. Indeed, thanks to its 12V motorization (to be connected directly to the cigarette lighter), the compressor will first create a vacuum cycle before injecting the different resins. The multiple pressure and vacuum cycles will then allow the resin(s) to penetrate well in order to achieve a quick and durable repair.

The 12V UV curing lamp supplied in the kit will allow the resin to dry automatically thanks to its integrated timer. This intervention will thus avoid the aggravation of the impact (or the crack) to avoid the complete replacement of the glazing.

+ Quality and speed of intervention.



NEW

Contents:

- metal support equipped with a strong suction cup + 2 others
- 12V pressure/depression compressor
- UV3 Leds lamp 12V
- 12V power cord (cigarette lighter type)
- air hose 1.5m
- mirror



ELECTRONIC STETHOSCOPE LEAK DETECTOR

AC 5028

The electronic stethoscope allows you, simply by touching with the tip during static testing, to transmit the sound made by the target through headphones to locate engine pinging, bearing noise, slapping, etc.

It also lets you detect air leaks normally imperceptible by the human ear by making the ultrasounds made by an airflow audible.



Specifications:

- can be operated with 2x9V batteries (6f22 type) or equivalent
- response frequency: 36000Hz to 44000Hz
- operating temperature: 0°C to 40°C
- storage temperature: -10°C to 50°C
- weight: amplifier 183g/transmitter 156g

Contents:

- amplifier 176x84x35mm
- ultrasonic transmitter 170x84x36mm
- headphones
- alu stethoscope probe 250mm
- plastic amplifier tube 270mm
- carrying case with foam



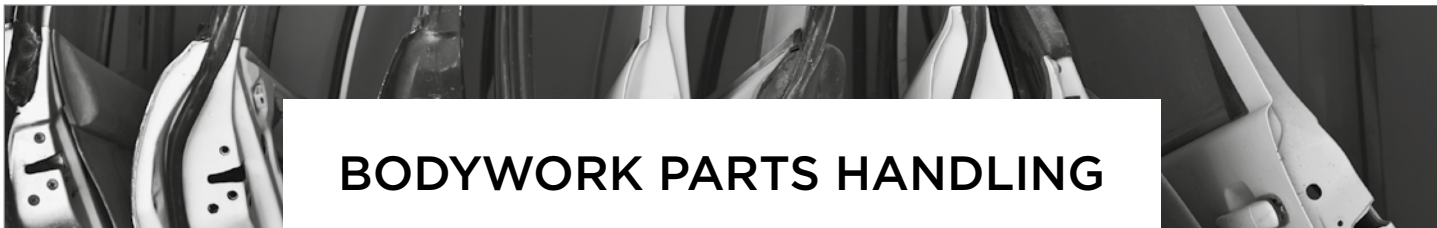

BODYWORK PARTS HANDLING

BODYWORK SUPPORT

OC 0717

Completely adjustable to accommodate a wide range of parts such as doors, bonnets, wings...

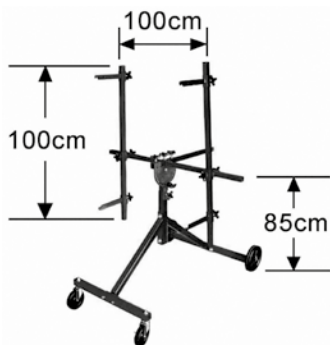

Max. Kg
140

2
WARRANTY

TN

MUST HAVE

BODYWORK 3 TRAY STORAGE TROLLEY

OC 0711

Allows parts which have been uninstalled to be put away and stored such as headlights, headrests, instrument panels, bumpers...

Specifications:

- 3 trays (2 wooden and 1 mesh)
- platform height: 260-810-1390mm
- mesh base
- 4 swiveling wheels, 2 of which have brakes
- dimensions: L.630xW.1110xH.1625mm

Max. Kg
100

2
WARRANTY

TN



RIM STAND

OC 0780



Specifications:

- suitable for 4 rims with tires
- adjustable height: 870-1050mm
- adjustable sliding handle stroke: 670mm
- equipped with 4 swiveling wheels and 2 swiveling braked wheels



2
WARRANTY

TN





BODYWORK VEHICLE HANDLING

VEHICLE DOLLY CASTER SYSTEM 1360kg (PAIR)

TN

OM 2024

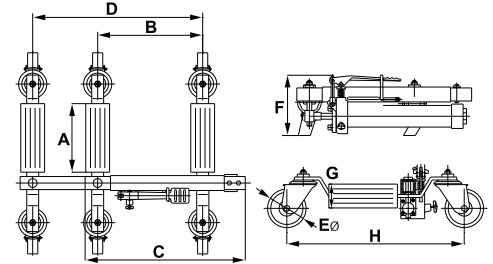

Specifications:

- lifting assisted by hydraulic ram
- aluminum roller L.300mm
- 4 casters, 2 with lock
- capacity: 1360kg
- max capacity: 18 inches (tires in 275)



	Dimensions (mm)							
	A	B	C	D	EØ	F	G	H
OM 2024	300	345	540	625	100	190	68	560



TROLLEY BLOCKED UNDER CAR BODY 450kg

TN

OC 1200

Articulated buffers
4 swiveling wheels Ø148mm
(SA7061)

height 350mm

width 600mm



from 1150 to 1800mm



SA 7061 PIVOTING DOLLY WHEEL Ø148mm





BODYWORK LIFTING

MUST-HAVE

TN

HYDROPNEUMATIC MOBILE LIFTING COLUMN 1500kg

OH 9150

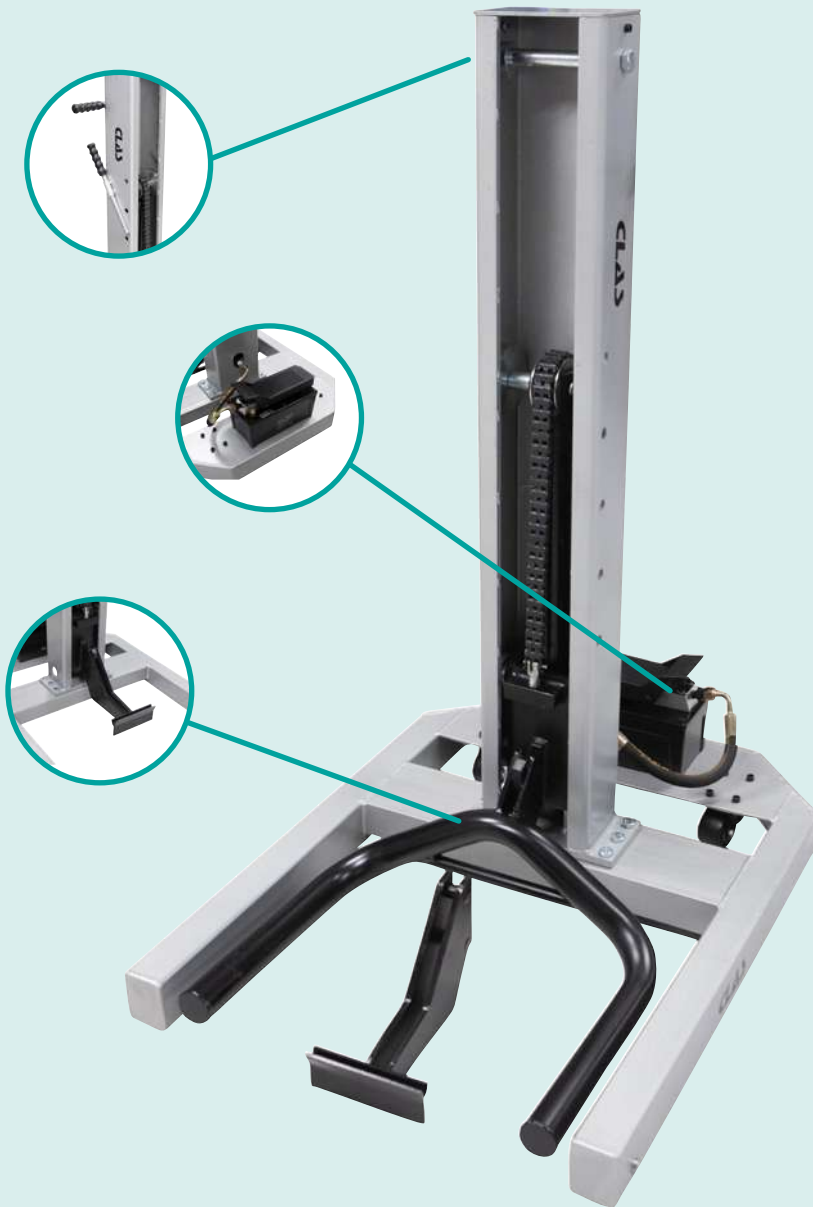

+ Allows the vehicle to be lifted in less than a minute.

Supplied with:

- SA9151: lifting under the wheel
Max. working height: 735mm
Min. height: 100mm
Wheel diameter from 480 to 730mm
- SA9152: lifting under the car body
Max. working height: 835mm
Min. height: 140mm

Specifications:

- 2 swivel wheels to facilitate handling
- safety pin: 5 secure heights
- lifting by the wheel or the car body
- mobile and fast

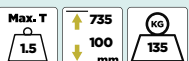

1.5T



**BODY REPAIR LIFT TABLE MONO CYLINDER WITH MECHANIC LOCK 400V 3T**

PE 8000T

BODY REPAIR LIFT TABLE MONO CYLINDER WITH MECHANIC LOCK 230V 3T

PE 8000M

+ High elevation

**Specifications:**

- lifting time: +/- 50 s
- lowering time: +/- 60 s
- working height: 260-1730mm
- closed dimension: L. 2348 X W. 700mm
- max. open dimension L. 2836 X W. 1610mm
- drive power 2.2 kW 220bar
- electrical voltage of the drive: (3 -) 400V/50 Hz
- air supply 6/8bar
- single-cylinder version, with mechanical hold-in position safety device (rack and pinion).
- opening of the 4 arms equipped with 120° buffers
- European origin
- powder coated hinges
- weight: 780kg

**3T** 2 WARRANTY**BODY REPAIR LIFT TABLE DUAL CYLINDER 400V 3T**

PE 8001T

BODY REPAIR LIFT TABLE DUAL CYLINDER 230V 3T

PE 8001M

+ Ratchet safety feature

**Specifications:**

- lifting time: +/- 50 s
- lowering time: +/- 60 s
- working height: 125-1300mm
- closed dimension: L. 1960 X W. 880mm
- max. open dimension: L. 2303 X W. 1668mm
- drive power 2.2 kW 220bar
- electrical voltage of the drive: (3 -) 400V/50Hz
- air supply 6/8bar
- double-cylinder version, with mechanical hold-in position safety device (rack and pinion).
- opening of the 4 arms equipped with 120° buffers
- European origin
- powder coated hinges
- weight: 880kg

**3T** 2 WARRANTY



STRAIGHTENING BENCH 3M

PE 8101

NEW

2.5T lifting table and 2.5T electro-hydraulic straightening bracket equipped with a mobile traction arm.

+ Quick set up of the vehicle.



This table allows to lift a vehicle up to 160cm in order to carry out works dedicated essentially to the bodywork and the straightening of shocks. Its desk (2 in 1) allows to control remotely with its remote control :

- the raising and lowering of the table
- the raising and lowering of the electro-hydraulic bracket

Specifications:

- Table:
- capacity: 2500kg
 - maximum height: 1600mm
 - length: 3000mm
 - width: 780mm
 - driving power: 1.8kW
 - power supply : tri 400V

- Bracket :
- power : 2500kg
 - cylinder deployment of 350mm
 - delivered with a 3000mm hydraulic hose

Contents:

- lifting table equipped with 4 arms with removable buffers to lift the vehicle
- straightening bracket equipped with its chain and a 3m hose
- 4 removable arms for the fixation of 4 holding vices

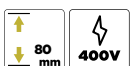

2.5T **2** WARRANTY





ROLLER CABINET

FIND THE COMPLETE RANGE OF **SERVANTE CARROSSERIE** HERE



ROLLER CABINET

MUST-HAVE

TN

BODY REPAIR ROLLER CABINET 190 TOOLS

EG 8888



OS 4100



OS 3000



OS 5000



OS 3200



OS 0850



OS 2000



OC 6081



OC 6080



OS 1000



OS 1100

- EG0087: 1 x 7 drawers roller cabinet
- OC081: 1 x hammer + block set (7 pcs)
- OM0749BL: 1 x riveting pliers
- SA0115: 1 x plastic chisel
- OC0033: 1 x trim clip plier
- OM8081: 1 x lock grip plier 190mm
- OM8080: 1 x lock grip pliers 225mm
- OP1510: 1 x 1/4"-3/8" d. mini ratchet wrench kit
- OP1203: 1 x mini die grinder ø6mm 25,000rpm
- OM0643: 1 x 5 carbide rotary rasps box
- EG0680: 1 x 25pcs drill set hss cobalt 5%
- EG8009: 1 x dispenser/hand towel roll stand for drawers
- EG8001: 1 x metal workshop waste for drawer
- OS3200: 1 x ratchet insert 1/4" (59pcs)
- OS4100: 1 x combination wrench insert 6-24mm (17 pcs)
- OS3000: 1 x 1/2" ratchet insert (23 pcs)
- OS5000: 1 x plier insert (4pcs)
- OS1000: 1 x screwdriver insert (8 pcs)
- OS1100: 1 x 7 pcs torx screwdriver insert t10-40
- OS2000: 1 x hex t-handle wrench insert 3-10mm (7 pcs)
- OC1700BL: 1 x windscreen wiper remover
- OC0302: 1 x scraper and utility knife set
- OC8078: 1 x 5 pcs nylon trim removal set
- SA0881: 1 x hammering insert
- OM0801: 1 x 6 pin driver set with base
- OM0803: 1 x automatic punch
- OM0160: 1 x rivoir hammer composite handle 1000gr
- OM0170: 1 x dead blow hammer with interchangeable tip 32mm
- OM0800: 1 x extra flat splitting chisel
- OP1451: 1 x ø13mm reversible drill
- OC6081: 1 x wide bodywork spoon
- OC6080: 1 x long bodywork spoon
- OP0099: 1 x straight blowgun pen





WELDING PLIERS

16 PACK LOCK GRIP PLIERS

TN

OM 8069



Contents:

- OM8082 (x3): lock grip pliers 285mm
- OM8080 (x5): lock grip pliers 225mm
- OM8083 (x3): lock grip pliers 240mm
- OM8081 (x5): lock grip pliers 190mm



LOCK GRIP PLIERS 225mm

OM 8080

Spare part of OM 8069



LOCK GRIP PLIER 190mm

OM 8081

Spare part of OM 8069



LOCK GRIP PLIER 285mm

OM 8082

Spare part of OM 8069



LOCK GRIP PLIER 240mm

OM 8083

Spare part of OM 8069



BODYWORK PLIERS

TN

OC 0025

Model equipped with a swiveling head to punch (Ø5mm) and fold (12mm) sheet steels before welding. For sheet steel 1.4mm maxi.



OVERLOAD CIRCUIT BREAKER 12-24V

TN

OE 1224

This device protects the vehicle electronically from overload.



- Max. clamping voltage 12V:
- 32.5V/308A (8-20µs)
 - 25.2V/59.5A (10-1000µs)
- Max. clamping voltage 24V:
- 59.0V/169A (8-20µs)
 - 45.7V/33A (10-1000µs)

+ Protect the electronics, avoids reprogramming clock/radio...



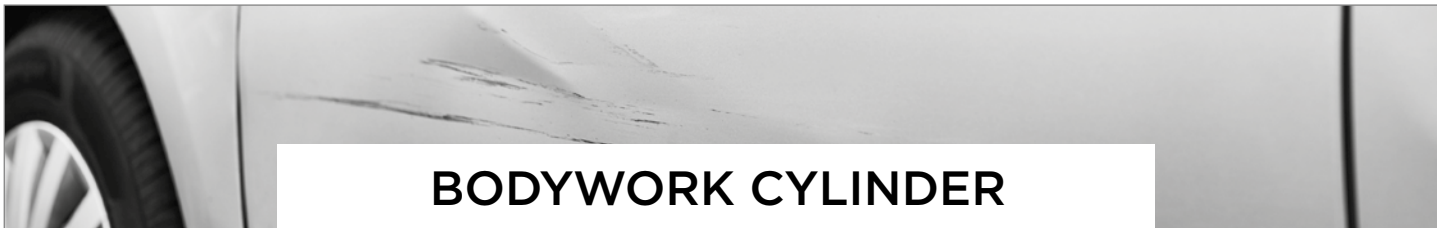

BODYWORK CYLINDER

4T COLLISION REPAIR SET

TN

OC 0803

Specifications:

- minimum pusher cylinder travel: 325mm
- maximum pusher cylinder travel: 425mm

Contents:

- SA0805: 4T hydraulic ram
- SA0806: 4T 1/4" hydraulic hand pump
- SA0804: spreader 500kg
- SA0802: hose 1/4"
- bit/support set
- SA1805: bodywork hydraulic ram 4T extension set



SA 0803	1/4 HYDRAULIC FEMALE ADAPTER	Spare part of OC 0803/OC 0804/OC 0801/OC 0802
SA 0804	SPREADER PLIERS	Spare part of OC 0803/OC 0804/OC 0801/OC 0802
SA 0805	4T HYDRAULIC RAM	Spare part of OC 0803/OC 0801
SA 0806	4T 1/4" HYDRAULIC HAND PUMP	Spare part of OC 0803/OC 0801
SA 0807	10T HYDRAULIC RAM	Spare part of OC 0804/OC 0802
SA 0808	10T 1/4" HAND PUMP	Spare part of OC 0804/OC 0802

MUST-HAVE

TN

10T COLLISION REPAIR SET

OC 0804

+ High power

A must-have tool for automotive and industrial repair work on straightening, handling and lifting.

For SA 1815 :

Delivered with a set of 5 sleeved extensions :

- usable length: 546mm (with 590mm nozzle, Ø 30mm sleeve) (x1)
- usable length: 300mm (with 342mm nozzle, Ø 30mm sleeve) (x2)
- usable length: 197mm (with 234mm nozzle, Ø 30mm sleeve) (x1)
- usable length: 97mm (with nozzle 140mm, Ø 30mm sleeve) (x1)

Contents:

- SA0807: 10T hydraulic ram
- SA0808: 10T 1/4" hydraulic hand pump
- SA0804: spreader 500kg
- SA0802: hose 1/4"
- bit/support set
- SA1815: bodywork hydraulic ram 10T extension set





TN

BODYWORK CYLINDER SET PUSHER/ PULLER 1/4"

OC 0705



SA 0703	MINI 4T RAM
SA 0704	2T RAM
SA 0705	MINI 10T RAM
SA 0706	4T RAM
SA 0707	10T RAM
SA 0708	5T PULLING JACK
SA 0709	2T PULLING JACK



AIR HYDRAULIC PUMP 10T 1/4"

OH 0014

Accessory of OH 9150



Delivered without hose (SA0802)

Specifications:

- 700bar
- aluminum frame
- internal load limiting device
- exhaust muffler
- dimensions: L.255xW.135xH.185mm

1.5T



TN

AIR HYDRAULIC PUMP 10T 1/4" & 3/8"

OH 0024

Accessory of DM 0204/OH 3453/OM 9385/OM 9387/OC 0705/OC 0803/OC 0804

Pump to be coupled with a multitude of hydropneumatic tools such as bodybuilder cylinders, hydraulic extractors etc...



Specifications:

- 700 bar
- aluminum housing
- oil capacity: 1.3l
- supplied with 2 types of MF 1/4" and 3/8" connections
- air inlet 1/4 MF connection, 25mm long
- air connection type ISO 6150 6mm M
- oil outlet M 3/8 F 1/4



NEW

1.5T



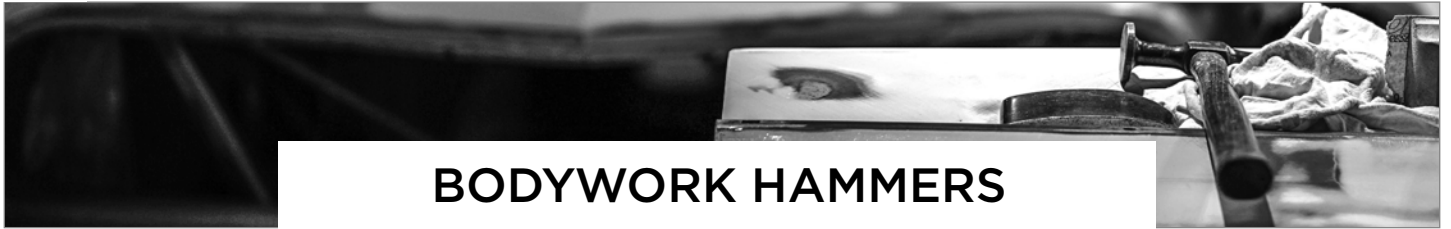

BODYWORK HAMMERS

MUST-HAVE

TN

HAMMER + BLOCK SET (7 PCS)

OC 0811

+ Hickory handle



OC 0812	PLANISHING HAMMER WITH ROUND FLAT HEAD AND POINTED TIP
OC 0813	PLANISHING HAMMER WITH HORIZONTAL TIP
OC 0814	FINISHING HAMMER ROUND/CROSS-HATCHED SQUARE
OC 0815	BLOCK COMMA 130x55mm
OC 0816	BLOCK RAIL/UNIVERSAL 60X60X56mm
OC 0817	BLOCK CLAW 78x60x27mm
OC 0818	BLOCK ANVIL 80x62x55mm

Contents:

- 3 hammers with GENUINE HICKORY handles L.310mm:
- OC0812: planishing hammer with round flat head and pointed tip
- OC0813: planishing hammer with round flat head straight tip
- OC0814: cornering hammer with round and square gridded head

4 blocks:

- OC0815: comma 130x27mm
- OC0816: rail/universal 60x60x56mm
- OC0817: claw 78x60x27mm
- OC0818: anvil 80x62x55mm



WIDE BODYWORK SPOON

TN

OC 6081

Dent removal spoon ideal for bodywork.



Specifications:

- forged steel
- length: 260mm
- width: 50mm



LONG BODYWORK SPOON

TN

OC 6080

Dent removal spoon ideal for bodywork.



Specifications:

- forged steel
- length: 335mm
- width: 45mm



BODYWORK SLIDE HAMMER SET

TN

OC 2211

Contents:

- hammer 4.5kg
- stroke 50cm
- handle with guard
- SA4221: pigs tail end
- SA4213: long curved hook 6cm
- SA4214: short curved hook 4cm
- SA4223: 90° hook U
- SA4216: 90° hook flat
- SA4218: straight end
- SA4219: screwed end
- SA4220: chain end





PAINTLESS DENT REMOVAL

AUTO DENT REPAIR KIT WITH SLIDE HAMMER

OC 0113

This kit is designed to repair car bodies which have been damaged by hail, or small dents with no need to repaint the part. The process consists of sticking plastic pulling tips with the gun and the glue especially made for bodywork, and to connect the inertial weight or the pulling lever and then have the painted sheet without damaging it. Then you can remove the pulling end with any cleaning solvent (not supplied) and the nylon chisel.

Contents:

- SA0112: inertial stainless steel hammer+pulling end
- SA0113: pulling lever (DSP) to remove dents
- SA4205: glue gun 240V-200°C-30W
- SA3110: 8 glue sticks
- SA0114: 12 pulling tips of various diameters
- SA0115: nylon chisel to remove the pulling tips
- SA0116: bottle of solvent to remove the pulling tips
- 1 strong PVC box



TN



10 BLACK GLUE STICK SET

OC 0403



Ø11mm
Rigid



TN

10 AMBER GLUE STICK SET

OC 0405

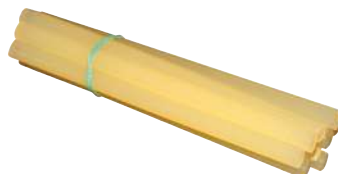

Ø11mm
Flexible



TN

10 WHITE GLUE STICK SET

OC 0406



Ø11mm
Intermediate



TN

STICKS OF STRONG GLUE 10 PIECES

SA 3110

Spare part of OC 0113



TN

12 PCS PULLING END SET

SA 0114

Spare part of OC 0112/OC 0113

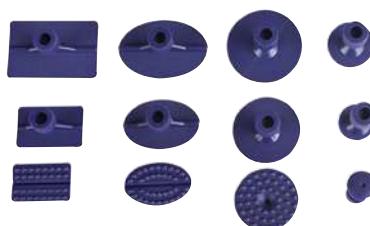

TN

AIR CAULKING GUN

SA 4205

Spare part of OC 0112



TN





TN

MANUAL VACUUM DENT PULLER

OC 0210

Slide hammer for paintless dent removal



Manual pump requiring no external air supply

Contents:

- SA0227: suction cup Ø75
- SA0228: suction cup Ø100
- SA0229: suction cup Ø125mm
- SA0224: draw hook
- SA0410: manual pump for venturi

Slide hammer weight: 1.22kg



SUCTION CUP SUPPORT RODS Ø120mm CAPACITY 20kg

OC 8110

Accessory of OC 8100



Suction cup for use with paintless bodywork rods (OC8100). The rods can be passed through 1 of the 5 holes in the strap to act as a pull lever.



TN



DOUBLE SUCTION CUP

OC 0608

TN



Suction strength 60kg
Ø160mm large suction cup
Ø90mm small suction cup



14 PCS BODYWORK ROD SET

OC 8100

TN



Assortment of 12 auto body work rods not requiring paint. Ideal for pushing out hailstone marks, small dents on a door and other marks. Supplied in a carry-case.

- Rod lengths:
- 1 x 280mm
 - 4 x 300mm
 - 1 x 350mm
 - 1 x 450mm
 - 2 x 700mm
 - 2 x 750mm
 - 1 x 900mm



SA 8001 4 END SET





TN

BODYWORK LAMP

OE 1226

Emits parallel beams, highlights bodywork deformations.



12 watt LED light supplied with tiltable suction cup holder with shape memory.



Specifications:

- 5m power cable
- on/off switch
- protective glass with 3 black stripes
- opal film
- 24V DC flexible LED strip
- light output approx. 800Lm
- suction cup Ø120mm and flexible arm 300mm long black with cross handle



MUST-HAVE

TN

INDUCTION DENT REMOVAL

OC 0350

Repairs slight dents in the bodywork without repainting.

Designed for straightening, equipped with a timer to regulate heating time to avoid burning the paint.

+ No preparation work, no need to repaint

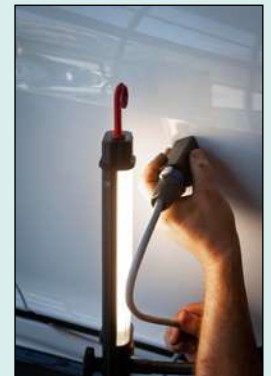

Specifications:

- Induction heater allows fast and efficient heating of metal and bodywork parts.
- Control and regulation of the heating time.
- Excellent way to repair small dents, such as hail.
- Easy to use and use
- Time saving through the use of induction technology





PLASTIC REPAIRING

TN

REAR PARKING SENSOR PUNCH TOOL KIT Ø17-Ø22mm

OM 0700

This hollow punch kit allows holes of the required diameter to be punched in the front and rear bumpers in order to install bumper sensors (reversing sensors).

+ Does not damage paintwork
No deburring



Requires a Ø8.5mm pre-punch

Specifications:

- tempered steel hollow punch
- max. punch diameter: 4 to 6mm depending on the diameter of the hollow punch
- compatible with pawls and ratchet hammers
- 13mm hex drive

CONTENTS

OM 0717	REAR PARKING SENSOR PUNCH TOOL Ø17mm
OM 0718	REAR PARKING SENSOR PUNCH TOOL Ø18mm
OM 0719	REAR PARKING SENSOR PUNCH TOOL Ø19mm
OM 0720	REAR PARKING SENSOR PUNCH TOOL Ø20mm
OM 0722	REAR PARKING SENSOR PUNCH TOOL Ø22mm

OM 0700 OPTIONAL KIT

OM 0730	REAR PARKING SENSOR PUNCH TOOL Ø30mm
---------	--------------------------------------





TN

PLASTIC REPAIR KIT

OC 6049

Ideal for small plastic repairs on bumpers, headlight fixings, mirrors, interior trim, etc.

Contents:

- SA6042: 1 soldering iron with special soldering tip
- SA6081: 6 brazing rods (PP-Polypropylene)
- SA6082: 6 brazing rods (PS-Polystyrene)
- SA6083: 6 brazing rods (PE-Polyethylene)
- SA6084: 6 brazing rods (ABS)
- SA6080: 5 pieces of 304 stainless steel grids
- soldering iron holder



AEROSOL COOLANT FOR PLASTIC REPAIRS

TN

SA 6039

Spare part of OC 6039

With its freezing power of 45°C, the gas rapidly cools the various adhesives used in bodywork, and can also shrink metal parts (bearings).



BI-COMPOSING GUN 50ml

TN

OC 1025

Allows the application of two-component adhesives in 50ml cartridges. Delivered with piston 2:1



TWO-PART EPOXY GLUE 25ml

TN

CO 1067

5 min epoxy glue is the glue for all those who want a fast (5-minute setting), ultra-resistant bond. This epoxy glue can be used on all substrates and materials: wood, metal, ceramics, glass, plastic, stone, earthenware, concrete, marble...



+ Takes less than 5 minutes



All-materials bonding.



BLACK STRUCTURAL GLUE 50ml

TN

CO 1024

Accessory of OC 1024/OC 1025

+ Ideal for plastic repair

- Specifications:**
- time required for structuring: 1min
 - time required for drying: 5min
 - 2K polyurethane glue





CORDLESS THERMAL STAPLER + 300 STAPLES KIT

OC 6070

Ideal for autonomous plastic repair.

Easy to use thanks to its 4-position articulated head (fast approach to work in corners or confined spaces).

Equipped with a thermal protection (30 seconds working cycle).

Also equipped with a Led on the head for a better visibility.

Stainless steel staples

NEW

+ Speed of intervention

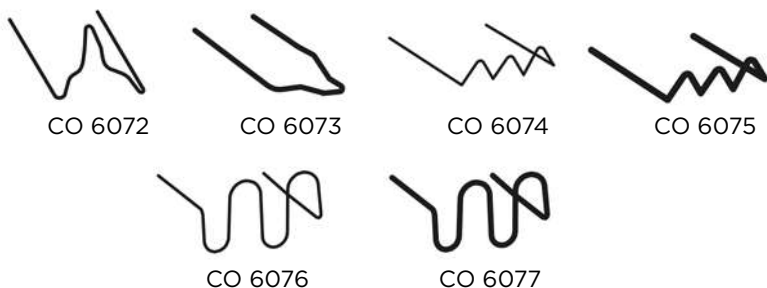

Protection against overheating

Max. temperature **600°C**

3.7V 4000mAh 4000mAh Li-ion battery

Specifications:

- length (without electrode): 220mm
- total length: 255 mm
- width: 35mm
- heating temperature: 600°C
- input current: DC 5V 2A
- output current: 3.7 8A Max
- battery: 3.7V 4000mAh Li-ion
- charging time : 3H
- capacity 400 staples with battery in one charge (hot stapler)



CO 6072	BOX OF 50 STAPLES M Ø 0.6 MM
CO 6073	BOX OF 50 STAPLES V Ø 0.8 MM
CO 6074	BOX OF 50 STAPLES S Ø 0.6 MM
CO 6075	BOX OF 50 STAPLES S Ø 0.8 MM
CO 6076	BOX OF 50 STAPLES U Ø 0.6 MM
CO 6077	BOX OF 50 STAPLES U Ø 0.8 MM

4-position adjustable head





BODYWORK PAINTING PREPARATION

CENTRAL VACUUM CLEANER 2x1300W

EG 0055

Accessory of OE 1319/OE 1318

Vacuum cleaner that can also be used as a central vacuum cleaner. Compatible with pneumatic and electric tools up to 1200W.

+ Automatic filter cleaning at each use



TN



Options:

- SA0409: 5 bags 77L
- SA5505: flexible Y-adapter for 2 operators
- SA5506: Y-pneumatic adapter for 2 operators

Accessories included:

- SA0405: hose Ø28mm 4.5m
- SA0406: filter

Specifications:

- 76L plastic tank mounted on 4 castors trolley
- 2 motors 1300W
- tool tray 600x480mm
- hose Ø28mm 4.5m with integrated pneumatic hose
- depression 23.5kPa
- air flow rate: 119l/s
- noise level: 68dB
- dimensions: 580x590x940mm



TN

5mm RANDOM ORBITAL PALM SANDER Ø150mm

OP 1311

2.5mm RANDOM ORBITAL PALM SANDER Ø150mm

OP 1312



CO 1311	MEDIUM MULTI-HOLE VELCRO® TRAY Ø150mm/8mm
CO 1312	3 FLEXIBLE INTERFACES Ø150/5mm
CO 1313	3 FLEXIBLE INTERFACES Ø150/10mm





TN

HIGH-FLOW SANDING GUN (ceramic nozzle)

OP 0615



Specifications:

- aspiration hose 3m
- service pressure: 6 to 8bar
- air consumption: 500L/min
- to be used with sand drum SA6614

HIGH-FLOW SANDING GUN (metal nozzle)

OP 0617



Specifications:

- air consumption: 750L/min
- working pressure: 8bar
- hose length: 1.2m

SA 6614 SYNTHETIC SAND CARDBOARD 25kg Accessory of OP 0615/OP 0617/OP 0618



MAGNETIC PAINTWORK SUPPORT WITH PLIERS

OC 0028

Designed for painting small components such as rear-view mirror shells, metal sections, plastic casings...

+ Flexible

Specifications:

- strongly magnetized Ø58mm base to attach to the walls of the paint booth.
- hose
- max. opening: 14mm
- max. load: 2.5kg
- length: 285mm





500ml PHOSPHATE TREATMENT

TN

CO 1078

Specially designed for fast-acting rust treatment.

This treatment and phosphating spray can be used as a preventive or curative rust treatment. It neutralizes oxidation already present or protects surfaces from future oxidation. Our triple-action phosphating treatment stops rust, degreases the surface and ensures high adhesion for immediate painting after treatment. Our treatment guarantees a stable, ready-to-paint surface for optimum paint durability.

+ Best before painting



NEW

High bonding
Insulates the surface
Fast action



STRIPPING LIQUID 1L

TN

CO 1086

Perfect for rust stripping, special high-efficiency soaking.

This solution rapidly dissolves all iron oxide. The liquid solution allows surfaces to be impregnated by soaking. This exclusive formula quickly dissolves rust without any mechanical intervention. Non-flammable product. Will not affect rubber materials such as seals. The product can be diluted in any proportion or used neat, depending on the oxidation level of the surface to be treated or the speed of dissolution required. Ideal for removing all traces of oxidation from metal or aluminum surfaces, it guarantees optimum results.

+ Special soaking



NEW

Dissolves rust
Special soaking
Highly effective



500ml STRIPPING GEL

TN

CO 1087

Perfect for rust stripping with precise, drip-free application.

This gel solution rapidly dissolves all iron oxide. The gel solution allows surfaces to be impregnated by spraying. This exclusive formula quickly dissolves rust. Its gel formula ensures good adhesion to all substrates. Non-flammable product. Will not affect rubber materials such as gaskets. Ideal for removing all traces of oxidation from metal or aluminum surfaces, it guarantees optimum results.



NEW

+ Precise application

Dissolves rust
High bonding
Highly effective



400ml RUST REMOVER SOLVENT

TN

CO 1088

Great for dissolving rust and freeing parts.

The rust remover treatment unlocks rusted parts. Its super-powerful active effect creates a reaction on contact with iron oxide, turning the solution from white to intense violet. This exclusive formula completely dissolves rusted connections, making them easy to unblock. It allows rapid absorption of the degreaser sprayed on beforehand. Its foamy formula ensures optimum adhesion to all surfaces, enhancing its efficiency.

+ 2 in 1



NEW

Chemical reaction
Dissolves rust
Makes declogging easier



**CONSUMABLES**

PAINT		
CO 1002	PLASTIC PRIMARY SPRAY 400ml	Color: transparent
CO 1004	VARNISH SPRAY 1K 400ml	Respect for colorimetry
CO 1027	EXPRESS PAINT REMOVER SPRAY 500ml	Active formula: quick and efficient
CO 1042	LIGHT GREY FILLER PRIMER 500ml	Fast drying time Quick sanding
CO 1042	LIGHT GREY FILLER PRIMER 500ml	
CO 1042	LIGHT GREY FILLER PRIMER 500ml	
CO 1044	BLACK FILLER PRIMER 500ml	

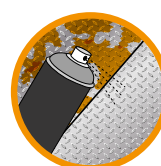

BODYWORK		
CO 1029	BODY REPAIR DEGREASING/CLEANING SPRAY 500ml	Degreases and removes silicone Antistatic
CO 1033	ANTI STONE-CHIP SPRAY 400ml	Exclusive thick formula, remains supple after drying
CO 1035	NO RUST SPRAY 400ml	Transparent
CO 1086	STRIPPING LIQUID 1L	Special soaking
CO 1087	500ml STRIPPING GEL	Precise application
CO 1088	400ml RUST REMOVER SOLVENT	2 in 1
CO 1078	500ml PHOSPHATE TREATMENT	Best before painting
CO 0505	5 PLASTIC RENOVATION WIPES	Easy to use
CO 0504	5 CHROME RENOVATION WIPES	
CO 0504	5 CHROME RENOVATION WIPES	



GLUE		
CO 1047	GREY GLUE AND MASTIC CARTRIDGE 310ml	Primerless bonding on metal surfaces
CO 1048	BLACK GLUE AND MASTIC CARTRIDGE 310ml	
CO 1022	WHITE GLUE AND MASTIC CARTRIDGE 310ml	
CO 1023	MULTI-FUNCTIONAL GLUE SPRAY 400ml	With no filament, it remains flexible after drying
CO 1024	BLACK STRUCTURAL GLUE 50ml	Ideal for plastic repair
CO 1034	ANTI GRAVEL MS POLYMER BLACK CARTRIDGE 310ml	Ideal for spray-on joints
CO 1057	ANTI GRAVEL MS POLYMER BEIGE CARTRIDGE 310ml	
CO 1058	ANTI GRAVEL MS POLYMER GREY CARTRIDGE 310ml	

Disponible également par carton de 12





BODYWORK PAINTING GUN

SANDBLASTING GUN

OP 1481

For projection of soundproofing products, sealants and anti-rust.

Specifications:

- nozzle Ø: 6mm
- working pressure: 8bar max.
- air consumption: 100 to 150l/min



TN



HVLP PROFESSIONAL SPRAY PAINT GUN

OP 1335

HVLP gravity gun for bodywork and finishing work.

Specifications:

- excellent spread and spray
- reworked ergonomics to make it more comfortable to handle
- stainless steel nozzle, brushed aluminum body Ø2mm
- polyamide tub 600ml
- filter
- service pressure: 1 to 2bar



SA 1312	Ø1.2mm NOZZLE
SA 1314	Ø1.4mm NOZZLE
SA 1316	Ø1.6mm NOZZLE
SA 1320	Ø2mm NOZZLE



Connector and Ø2mm nozzle supplied

TN



MINI PROFESSIONAL SPRAY GUN HVLP

OP 1336

HVLP gravity gun for retouching and finishing.

Specifications:

- excellent spread and spray
- ergonomic, easy to hold
- Ø0.8mm nozzle
- filter
- service pressure: 1 to 2bar



Connector and Ø0.8mm nozzle supplied

TN



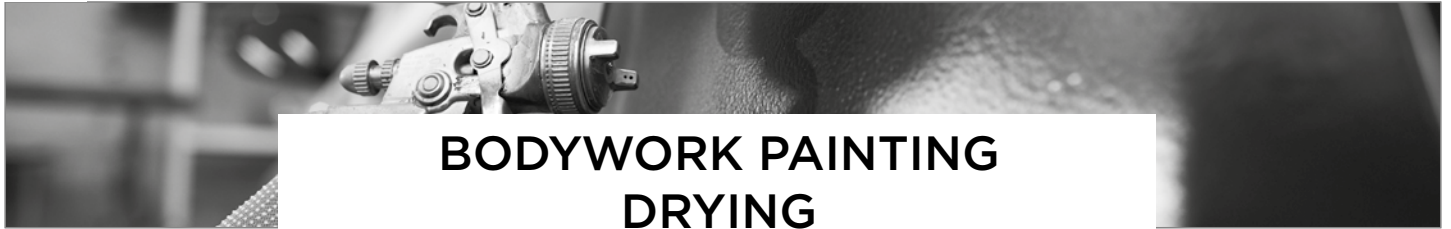

BODYWORK PAINTING DRYING

MUST-HAVE

TN

STRAIGHT BLOWGUN PEN

OP 0099

+ Always close to hand



- pocket blowgun
- adjustable flow
- duralumin body
- length 110mm
- opening/closure by rotation



DRYING GUN

TN

OP 3501



Specifications:

- compressed air venturi system
- airflow regulator
- max. flow 6bar
- consumption 350l/min
- noise level in dB: 72dB at 3.5bar
- service pressure 2 to 4bar
- dust filters



2 DRYING GUNS + BASE

TN

OP 3510



Specifications:

- ideal for drying tops and bottoms of vehicles
- fully adjustable base max. 2.08m
- power supply via spiral hose
- fast connectors
- 2 guns can be up to 0.85m apart

4 DRYING GUNS + 2 BASES

OP 3520

Specifications:

- ideal for drying tops and bottoms of vehicles
- fully adjustable base max. 2.08m
- power supply via spiral hose
- fast connectors
- 2 guns can be up to 0.85m apart





DOORS & CABIN

AIRBAG LINE TEST

AC 7023

TN



12 PIECE AIRBAG MAINTENANCE TOOL SET

OM 0200

TN



AIR WEDGE

OC 1103

TN

For keeping pneumatically-operated doors open to make it easier to install windcreens.

+ Rigid PVC panel:
makes insertion
easier



Cushion dimensions:
155x165mm



DOOR OPENING SET (9 PCS)

OC 9000BL

TN

Kit comprising tools and rods allowing a vehicle door to be opened without breaking the windows if its keys have been locked inside.

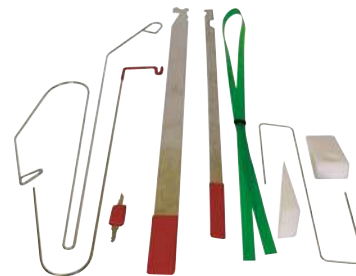

B.LINE
BUDGET SOLUTION

Strictly for professional use only.
Supplied without instructions.



SEMI-RIGID ROD TO HOOK DOOR HANDLES OR KEYS 1.80m

EG 0743

TN

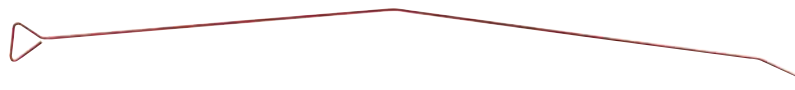

U-SHAPED SEMI-RIGID ROD TO HOOK DOOR HANDLES 1.50m

EG 0744



SLIP KNOT SEMI-RIGID ROD TO HOOK DOOR HANDLES 1.10m

EG 0745





BODYWORK STAPLES

← FIND THE COMPLETE RANGE OF BODYWORK STAPLES HERE



BODYWORK STAPLES

5 PCS NYLON TRIM REMOVAL SET

OC 8078



TN

NO WARRANTY

GARNISHING TRIM SET (27PCS)

OC 8881

The tools are made of composite material to preserve damage to the components. The different models allow to work in many different settings.

Delivered in a thick canvas storage case with a slot for each tool.

Lever set to remove door panels, window moldings, dashboards and trim, both inside and outside. They can also be used to remove glue remains.



TN

NO WARRANTY

TOOL FOR REMOVING DOOR STAPLES

OC 8081



TN

2 WARRANTY

TRIM CLIP PLIER

OC 0033



TN

OEM codes : 3392

2 WARRANTY





CONSUMABLES

**LUBRICANT**

REF	Base	Color	Texture	Dry lubrication	Oily lubrication	Protects	Degreases	Water-resistant
CO 1030	Silicone	Transparent	Liquid	•	•	•		•
CO 1026	Graphite	Transparent	Liquid		•	•	•	•
CO 1025	Oxygenated solvent	White	Foam		•		•	
CO 1031	Teflon	White	Liquid	•				•
CO 1049	Dielectric		Liquid			•		•
CO 1088	Solvent		Liquid				•	

SUPER RELEASING GRAPHITE SPRAY 400ml

TN

CO 1026



Releases and protects, minimizes friction and stops rust.

+ Long-term protection

Also available in box of 12

**LUBRICANT TEFLON SPRAY 500ml**

TN

CO 1031



+ Without residues of fat and silicone: dust does not stick.

Also available in box of 12

**INJECTOR/GLOW PLUG RELEASER 500ml**

TN

CO 1025



+ Foaming penetrating formula, dissolves calamine and soot.

Also available in box of 12

**LUBRICANT SILICONE UNIVERSAL SPRAY 500ml**

TN

CO 1030

+ Anti corrosion
Anti oxidation

Also available in box of 12

**ELECTRIC SPRAY CLEANER 400ml**

TN

CO 1049



Also available in box of 12

**400ml RUST REMOVER SOLVENT**

TN

CO 1088



+ 2 in 1





ADDITIVES

CONSUMABLES

REF	Environment	Filling	Preventive	Curative	Max. dilution ratio
CO 1010	Diesel	Fuel tank	•	•	1 bottle/80L
CO 1011	Diesel	Fuel tank	•	•	1 bottle/80L
CO 1080	Diesel	Fuel tank	•	•	1 bottle/80L
CO 1005	Gasoline	Fuel tank	•	•	1 bottle/80L
CO 1084	Gasoline	Fuel tank	•	•	1 bottle/80L
CO 1085	Gasoline	Fuel tank	•	•	1 bottle/80L
CO 1082	Gasoline	Fuel tank	•	•	1 vial/80L
CO 1081	Gasoline	Fuel tank	•	•	1 bottle/80L
CO 1009	Engine oil	Oil filling	•	•	1 vial/12L
CO 1015	Engine oil	Oil filling	•	•	1 vial/6L
CO 1014	Engine oil	Oil filling		•	1 vial/5L
CO 1083	Engine oil	Oil filling	•		1 vial/85L
CO 1017	Engine oil/ Gearbox	Oil filling	•	•	1 bottle/5L
CO 1012	Coolant	LR jar	•	•	1 vial/8L
CO 1013	Coolant	LR jar		•	1 vial/5L
CO 1016	Gearbox	Oil filling		•	1 vial/3L
CO 4065	Air conditioning	Air-conditioning circuit	•	•	1 bottle/1 circuit
CO 4070	Air conditioning	Air-conditioning circuit	•	•	1 bottle/1 circuit

300ml RADIATOR LEAK SEALER

TN

CO 1012

Plugs leaks in the coolant circuit, ensures the radiators and water pumps are leakproof and avoids overheating.

Treats 4 to 8L of liquid.



+ Exclusive gel formula with flakes of aluminum incorporated



Also available in box of 24



300 ml ENGINE LEAK STOP

TN

CO 1014

Additive to stop oil leaks and seepage on diesel, petrol and LPG engines. Compatible with mineral, semi-synthetic and synthetic oils. Does not clog the oil circuit. Long-lasting effectiveness.



Also available in box of 24





TN



AIR CONDITIONING LEAK STOP FOR R134a 30ml

CO 4065

AIR CONDITIONING LEAK STOP FOR R1234yf 30ml

CO 4070

+ Economical solution



Also available in box of 35



50 ml GEARBOX LEAK STOP

CO 1016

Do not use for automatic transmissions and integrated oil bath clutches.



TN

300 ml ANTI-FRICTION ENGINE/GEARBOX

CO 1017

Preventive and curative anti-friction for engines and gearboxes. Reduces friction and provides a wear-resistant coating for long engine life. Revives gaskets.



TN



Also available in box of 24



Also available in box of 24



300 ml COOLING SYSTEM CLEANER

CO 1013

Dilution: 6 to 7.5% (one bottle for 4 to 5L of coolant)



TN

300ml ENGINE CLEANER BEFORE DRAINING

CO 1015

High performance preventive and curative cleaner for oil circuits.



TN



Also available in box of 24



Also available in box of 24



DPF CLEANER 375ml

CO 1011

Specifications:

- unblocks clogged DPFs up to 45%
- comply with the dosing instructions
- dosing: preventive 0.47% (1 for 80l), curative 0.75% (1 for 50l)



TN

300ml ENGINE CLEANER BEFORE DRAINING FOR HYBRID VEHICLES

CO 1083

+ Directly into the oil filler

Specifications:

- cleans the oil circuit and eliminates deposits
- fluidizes oil for easier draining
- cleans and silences hydraulic valve lifters
- neutralizes harmful acids in the engine



TN



Also available in box of 24





EGR VALVE AND CATALYST CLEANER FOR HYBRID VEHICLES

TN

CO 1084

+ Ideal before technical inspection



Specifications:

- treats up to 80 liters with a 300ml dose
- eliminates deposits
- reduces consumption



250ml BIOETHANOL INJECTOR CLEANER

TN

CO 1085

Easy to use without dismantling or immobilizing the vehicle. Concentrated formula treats up to 20 liters of bioethanol with a dose of 20ml (1:1000 ratio). Preventive or curative formula Does not damage injection system seals



+ No disassembly, mix directly with fuel



INJECTOR CLEANER FOR HYBRID PETROL VEHICLES

TN

CO 1082

+ No disassembly - mix directly with fuel



Specifications:

- treats up to 80 liters with a 300ml dose
- preventive and curative formula
- does not damage injection circuit seals



ENGINE OIL TREATMENT 300ml

TN

CO 1009

High performance preventive and curative treatment for oil circuits. Cleans parts in contact with oil, improves combustion, reduces friction and deposits a wear-resistant coating on all petrol and diesel engines. Revives gaskets.



Also available in box of 24



5 IN 1 DIESEL ENGINE CLEANER

TN

CO 1080

Treats up to 80 liters with a 375ml dose Preventive and curative formula Does not damage injection circuit seals

+ No disassembly, mix directly with fuel



5 IN 1 PETROL ENGINE CLEANER

TN

CO 1081

Treats up to 80 liters with a 375ml dose Preventive and curative formula Does not damage injection circuit seals

+ No disassembly, mix directly with fuel



5L CONTAINER OF BRAKES CLEANER

TN

CO 1530

Accessory of EG 1530/EG 1532



TUB OF ULTRASOUND CLEANING SOLUTION CONCENTRATE 25% 2L

TN

SA 7070

Accessory of OE 7201/OE 7200/OE 7100



Specifications:

- dilution: 25%





CONSUMABLES

FIND THE COMPLETE RANGE OF CONSUMABLES HERE

CONSUMABLES



PETROL TECHNICAL CONTROL PACK

TN

CO 1007

CO1005 : 1 x petrol injector cleaner 300ml
CO1009 : 1 x engine oil treatment 300ml
EM1043 : 1 x packaging for petrol technical inspection



+ Facilitates the passage to the technical inspection

DIESEL TECHNICAL CONTROL PACK

CO 1008

CO1005 : 1 x limpiador inyectores gasolina 300ml
CO1009 : 1 x tratamiento aceite del motor 300ml
EM1043 : 1 x envases para el control técnico de la gasolina



+ Optimal result after 300km



TN

ANTI-CRYSTALLIZATION ADDITIVE AdBlue® 300ml

CO 1059

ANTI-CRYSTALLIZATION ADDITIVE AdBlue® 5L

CO 1060

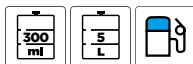

DPF CURATIVE CLEANER 400ml

TN

CO 1068

+ Curative treatment Unmountable Evaporates without leaving residue



GLUES

GLUE/MS POLYMER SEAL

REF	Color	Direct application to bare steel, aluminum, plastic, paint and glass	Tear strength	Elongation at break	Wet-on-wet paintable	UV resistance
CO 1022 CO 1047 CO 1048	White Grey Black	•	21 N/sqm	450%	•	•
CO 1034 CO 1057 CO 1058	Black Beige Grey	•	7,7 N/sqm	250 %	•	•
CO 1041	Black	•	26 N/sqm	350 %	•	•

GLUE

REF	Base	Color	Texture	Application bare steel, aluminum	Plastic and paint application	Glass application	Breaking strength	Application time	Drying time
CO 1022	Elastomère	Black	Vat	•	•	•	<400%	20 min	45 min
CO 1046	Epoxy	Grey	Solid	•	•	•	20 Nm	3 min	10 min
CO 1023	Néoprène	White	Spray	•	•	•	35Kg/cm ³	1 min	1 h
CO 1024	Polyuréthane	Black	Pasty	•	•	•	20 N/sqm	1 min	5 min
CO 1032	Cyanoacrylate	Transpa- rent	Semi- liquid	•	•	•	18 Nm	Immediate	30 s
CO 1067	Epoxy	Grey	Paste	•	•	•	20 Nm	Immediate	15 min



TN



Also available in box of 6



ANTI GRAVEL MS POLYMER BEIGE CARTRIDGE 310ml

CO 1057



ANTI GRAVEL MS POLYMER GREY CARTRIDGE 310ml

CO 1058



ANTI GRAVEL MS POLYMER BLACK CARTRIDGE 310ml

CO 1034



CONSUMABLES

TN



Specifications:

- elastomer: 300% elasticity
- touch dry: 5-10min
- without solvent



WHITE GLUE AND MASTIC CARTRIDGE 310ml

CO 1022



GREY GLUE AND MASTIC CARTRIDGE 310ml

CO 1047



BLACK GLUE AND MASTIC CARTRIDGE 310ml

CO 1048



SCREEN ADHESIVE CARTRIDGE 290ml

CO 1041

Specifications:

- MS polymer
- integrated primer
- application width 10 to 14mm
- drying: 2 hours at heart (at 20°C)
- hardness: SHORE 60



Also available in box of 12



TN



MASTIC REPAIR BAR TO MODEL METAL 57g

CO 1046

Allows repairing broken metal, sealing a radiator, recreating fixing brackets, rethreading on all types of metals...



TN



TWO-PART EPOXY GLUE 25ml

CO 1067

All-materials bonding.

+ Takes less than 5 minutes



TN



**BLACK SEALANT CARTRIDGE -40/+250 DEGREES 200ml**

TN

CO 1020

Allows joints to be sealed (sump, water pump, gearbox) and mechanical parts (fuel pumps, carburetors).

+ Resistant to hydrocarbons

Specifications:

- elastomer: 400% elasticity
- resistant to high temperatures (250°C)
- drying by touch: 20min
- vacuum package, with trigger

**FLEXIBLE INSTANT GLUE 20g**

TN

CO 1032



Particularly adapted for sticking on interior rear-view mirrors.
Quick connection.

Applications: fabrics, plastic, rubber, metal, elastomer, wood...etc
Universal cyano-acrylate glue, high viscosity

+ Rapid and instantaneous adhesion

Also available in box of 48



Prevents assemblies subject to vibrations from unscrewing. Affixes screws/bolts and various threads while allowing easy removal using tools.

MEDIUM-STRENGTH THREAD LOCK 10ml

TN

CO 1038

**STRONG THREAD LOCK 10ml**

CO 1039



Also available in box of 48

**MULTI-FUNCTIONAL GLUE SPRAY 400ml**

TN

CO 1023

Allows headliners, trims, rods, engine foams, upholstery, vinyl, carpet to be glued...

+ With no filament, it remains flexible after drying



Also available in box of 12

**BLACK STRUCTURAL GLUE 50ml**

TN

CO 1024

Accessory of OC 1024/OC 1025

+ Ideal for plastic repair

Specifications:

- time required for structuring: 1min
- time required for drying: 5min
- 2K polyurethane glue



Also available in box of 48





CLEANING



CONSUMABLES

REF	Surface	Texture	Active formula	Degreaser	Cleans	Protect	Paint compatible
CO 1019	Ventilation circuit	Foam	•		•		
CO 1049	Electrical component	Liquid			•	•	
CO 5002	Any support	Impregnated wipes	•	•	•	•	•
CO 5003	Any surface	Impregnated wipe	•	•	•	•	•
CO 5004	Metals	Impregnated wipe	•	•	•	•	•
CO 5005	Plastic	Impregnated wipe	•	•	•	•	•

TN



ELECTRIC SPRAY CLEANER 400ml
CO 1049

Cleans and protects electrical connectors.
Dissolves corrosion.
Eliminates false contacts, leakage currents and reduces voltage drops.
Improves productivity.

400 ml

Also available in box of 12

NO WARRANTY

TN



AIR CONDITIONING CIRCUIT CLEANER 400ml
CO 1019

Cleans air-conditioning circuits and eliminates bacteria/germs. Enough to clean the system approx. 3 times.

400 ml

NO WARRANTY

+
Antibacterial/
deodorizing

TN

HAND CLEANSING WIPES (80 PCS)
CO 0502

+
Double-sided: soft & rough
Hypoallergenic and paraben-free



Specifications:

- Double-sided: soft & rough
- Removes dirt, grease and grime
- Hypoallergenic and paraben-free
- Protects the epidermis: enriched with Aloe vera
- Citrus fragrance

NO WARRANTY

TN

CAR CLEANING WIPES (80PCS)
CO 0503

+
Cleans, protects,
antistatic, water-repellent, high-gloss



Specifications:

- cleanses
- protects
- antistatic
- water-repellent
- high gloss
- biodegradable

NO WARRANTY

TN

5 CHROME RENOVATION WIPES
CO 0504

+
Easy to use



Specifications:

- restores metal shine
- eliminates traces of oxidation
- easy to use
- impregnated wipe PH 9.00 Low base

NO WARRANTY

TN

5 PLASTIC RENOVATION WIPES
CO 0505

+
Easy to use



Specifications:

- restores the original appearance of plastics
- effective on all types of ABS
- safe for painted parts
- compatible with all shades
- impregnated wipe

NO WARRANTY



BODYWORK PAINTING

STRIPPING LIQUID 1L

TN

CO 1086

Perfect for rust stripping, special high-efficiency soaking.

+ Special soaking



500ml STRIPPING GEL

TN

CO 1087

Perfect for rust stripping with precise, drip-free application.

+ Precise application



NO RUST SPRAY 400ml

TN

CO 1035

Stops rust developing on bodywork and running gears. For preventative and curative use.

+ Transparent



Also available in box of 12



500ml PHOSPHATE TREATMENT

TN

CO 1078

Specially designed for fast-acting rust treatment.

+ Best before painting



BODY REPAIR DEGREASING/ CLEANING SPRAY 500ml

TN

CO 1029

Allows you to degrease and clean bodywork parts before painting or adhesion. Eliminates residues of glue, grease, oil, silicone.



EXPRESS PAINT REMOVER SPRAY 500ml

TN

CO 1027

Allows paint, varnish and ink pickling on every body repair painted element. Remove burned and imbedded seals (cylinder head, gearbox, water pump, etc).

+ Active formula: quick and efficient





BODYWORK DEGREASER 1L

TN

CO 0506



Specifications:

- compatible with all surfaces
- dries quickly, leaving no residue
- easy to use
- cleans and degreases all types of dirt
- liquid Fluid
- dilutable
- PH in aqueous solution: at 15% = 13.1



BODYWORK DEGREASER 5L

TN

CO 0507



Specifications:

- compatible with all surfaces
- dries quickly, leaving no residue
- easy to use
- cleans and degreases all types of dirt
- liquid Fluid
- dilutable
- PH in aqueous solution: at 15% = 13.1



BUMPER STRUCTURING SPRAY MEDIUM GRIT 400ml

TN

CO 1003

+ Scratch-resistant



Specifications:

- medium grit
- black color



Also available in box of 12



ANTI STONE-CHIP SPRAY 400ml

TN

CO 1033

+ Exclusive thick formula, remains supple after drying



Also available in box of 12



Allows application without primer on any support (metal, plastic and aluminum). Removes unevenness, provides a homogeneous and uniform surface before sanding. Filling up to 120µ

Also available in box of 12

+ Fast drying time
Quick sanding

 BLACK FILLER PRIMER 500ml
CO 1044

 DARK GREY GARNISHING PRIMER 500ml
CO 1001

 LIGHT GREY FILLER PRIMER 500ml
CO 1042





TN

PLASTIC PRIMARY SPRAY 400ml

CO 1002

Allows all plastic surfaces to be primed before painting or gluing.



Also available in box of 12

Color: transparent



VARNISH SPRAY 1K 400ml

CO 1004

Enables varnishing and protecting topcoats while providing a high-gloss finish. Excellent for body parts (hoods, doors, fenders, rocker panels, rims, etc.). Transparent, UV and scratch-resistant.

+ Respect for colorimetry

CARDBOARD DISPLAY WITH 3 SHELVES

PR 2019

TN



TN

Also available in box of 12





CLOTHING & ACCESSORIES

TWO-TONE BEANIE

AP 7500

TN



Specifications:

- two-tone beanie with cuff
- unisex
- double knit
- - embroidered CLAS logo
- 100% polyacrylic



NASCAR CAP WITH 3D EMBROIDERY

AP 7000

TN



Specifications:

- 260g premium cotton twill cap
- 6 panels
- pre-curved sandwich visor
- hook and loop closure
- 3D embroidered CLAS logo



1 DRAWER TOOLBOX-FRIDGE 50L

AP 0080

TN

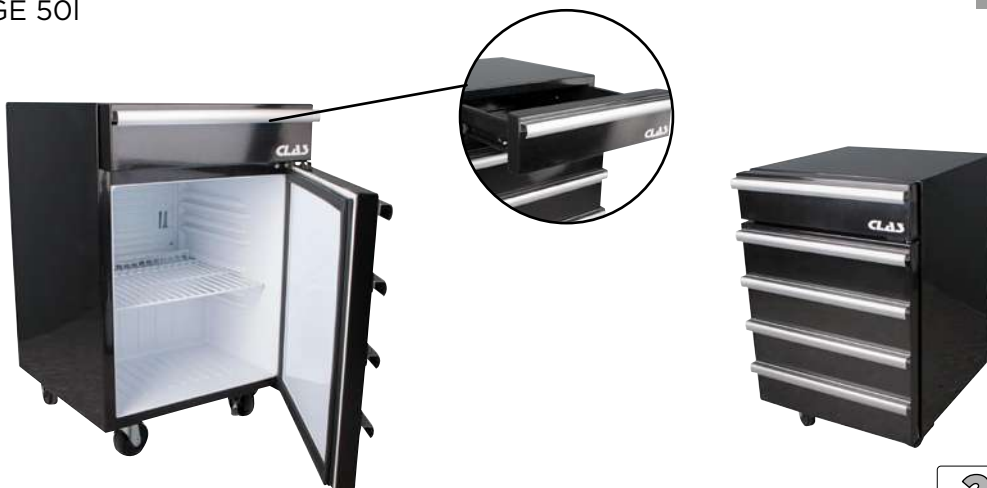

Specifications:

- total size: W.438xD.539xH.672mm
- 1 refrigerated compartment 50L + 1 drawer
- adjustable refrigerator
- 4 wheels: 2 fixed, 2 swivel



STRETCH PANTS BLACK

Pants with belt loops and elastic waistband, zip and button closure. Reinforced triple-needle seams at crotch and inside leg, double-needle side seams, two classic-cut front pockets, small coin pocket, right-side ruler pocket, left-side pocket with flap closure, two back pockets, one with flap and Velcro.



REF	SIZE	
AP 9500	XS	
AP 9501	S	
AP 9502	M	
AP 9503	L	
AP 9504	XL	
AP 9505	2XL	
AP 9506	3XL	
AP 9507	4XL	



TWO-TONE SWEATSHIRT

REF	SIZE	
AP 5200	S	
AP 5201	M	
AP 5202	L	
AP 5203	XL	
AP 5204	2XL	
AP 5205	3XL	

Specifications:

- 80% combed cotton / 20% polyester
- brushed fleece
- headphone loop in kangaroo pocket and neckline
- ribbed cuffs and bottom hem
- Contrasting lined hood with drawstring
- embroidered CLAS logo on chest
- certified STANDARD 100 by OEKO TEX®N CQ1007/7, IFTH



BLACK POLO SHIRT

REF	SIZE	
AP 5300	S	
AP 5301	M	
AP 5302	L	
AP 5303	XL	
AP 5304	2XL	
AP 5305	3XL	

Specifications:

- 200g quilted mesh
- 100% cotton
- ringspun
- ribbed collar and bottom sleeves
- contrasting lining on collar
- short sleeves
- 2 pearly white buttons on placket
- spare button on inner side seam
- embroidery CLAS on heart side and tag on bottom of sleeve



SLEEVELESS BODYWARMER

Premium men's padded bodywarmer with Oeko tex® Standard 100 certification, featuring lightweight microfiber padding for excellent warmth retention. It has many other practical features, including a contrasting full-length zipper with chin guard, and zipped pockets. For a more polished design, the bottom and hem of the sleeves are finished with black elastic trim. High-quality with excellent finishings, this bodywarmer is practical for the off-season. What' else? it's going to be one of the most popular layering piece in your clothing collection.

REF	SIZE	
AP 7400	S	
AP 7401	M	
AP 7402	L	
AP 7403	XL	
AP 7404	2XL	
AP 7405	3XL	



HYBRID WORKWEAR JACKET

Ultra-resistant and water-repellent. PVC coating for optimum waterproofing. 2-layer softshell, 4-way stretch fabric for ease of movement, with fleece inner layer for extra warmth on sleeves and shoulders. Front and back: 100% polyester, 75 g taffeta 230T with coating. Water-repellent fabric. 2 front zip pockets. 1 name tag on inside left. Contrast piping on armholes and inside collar. Front zipper and contrasting pockets. Invisible personalization zip at bottom of garment. Ideal for everyday wear.

REF	SIZE	
AP 8400	S	
AP 8401	M	
AP 8402	L	
AP 8403	XL	
AP 8404	2XL	
AP 8405	3XL	

A PARTNERSHIP THAT SHARES OUR VALUES

The Club Technique Auto, a corporate approach that is part of our DNA!

We are involved in technical trainings for professionals and learning centers, with the «Club Technique Auto», founded in association with brands SNR® and Elring®. The aim of the CTA (Club Technique Auto) is to share our knowhow by increasing the awareness of the good practices by educating them to new technologies with the help of specific tools.

Winner of the 2021 Equipment Award (Service category), the CTA confirms the validity of this approach.

Several trainings have already taken place and many more are to come, follow us on club-technique-auto.com



CLUB TECHNIQUE AUTO
LA TRANSMISSION DU SAVOIR



CLAS[®]

83 Chemin de la Crouza
73800 Chignin - FRANCE

Tél. +33(0)4 79 72 62 22

Fax +33(0)4 79 72 52 86

contact@clas.com

clas.com

